

▲ Photo by: Voyages Of Agape

▲ Photo by: Alberto Balbi



#WE
MANUFACTURE
QUALITY SINCE
1946

CRESSI

SINCE 1946

CATALOG 2022

SCUBA DIVING FREEDIVING SPEARFISHING

▲ Photo by: Roberto Ochoa

cressi.com



INDEX

BUYER'S GUIDE

COLLECTION 2022



CRESSI WHO WE ARE

Join the Cressi Family	6
History	8
Territory	10
Headquarters	11
Net	12



BUYER'S GUIDE OUR DNA

Branding	14
B2B & PMI	15
E-Learning	15
Social Media	16
Ambassadors	20

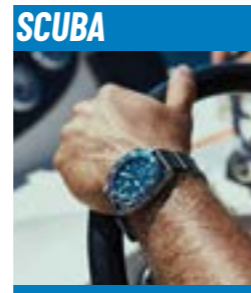

WATCHES

Scuba Watches	27
---------------	----



DIVE COMPUTERS

Watch-Style Dive Computers	29
Big-Screen Dive Computers	38
Interfaces	52



DIGITAL CONSOLES

Digital Gauges	55
----------------	----

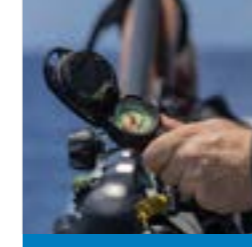

ANALOGIC GAUGES

Digital Gauges	55
----------------	----



ACCESSORIES & SPARE PARTS

Dive Computer Accessories	60
Console Spare Parts	62

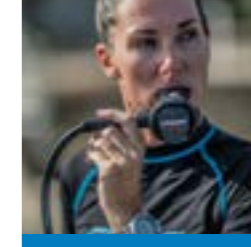

REGULATORS

First Stages & Second Stage	66
Octopuses	82
Comparison Chart	84
Regulator Parts	86
Regulator Tools	90

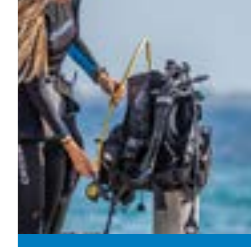

B.C.D

Scuba BCDS	93
Comparison Chart	110
Scuba Packages	113
B.C.D Accessories	115
B.C.D Tools	117



SCUBA FINNS

Scuba Fins	120
Fins Spare Parts	136



SCUBA MASKS

Scuba Mask	138
Comparison Chart	169
Mask Spare Parts	170
Scuba Mask Optical Lenses	172
Scuba Mask Accessories	173

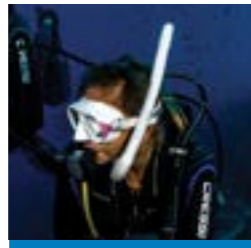

SCUBA SNORKELS

Snorkels	175
Snorkel Spare Parts	185

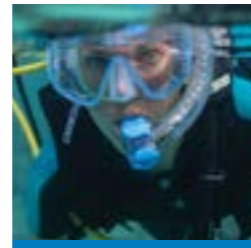

SCUBA COMBOS

Scuba Combos	183
--------------	-----



TORCHES

Scuba Torches	188
---------------	-----



KNIVES

Scuba Knives	191
Clean-Up Tools	192



SCUBA WETSUITS

Drysuits	194
Drysuits Undersuits	195
Full Wetsuits	196
Short Wetsuits	204
Skin Protections	207



NEOPRENE ACCESSORIES

Hoods	209
Gloves	211
Boots	212
Socks	216



SCUBA BAGS & BACKPACKS

Gear Bags	219
Dry Bags	222
Net Bags	225
Bags	228



FREEDIVING COMPUTERS

Freediving Computers	230
----------------------	-----



FREEDIVING FINNS

Long Blade Fins	236
Fin Accessories	250



FREEDIVING MASKS

Masks	252
Combos	264
Snorkels	277

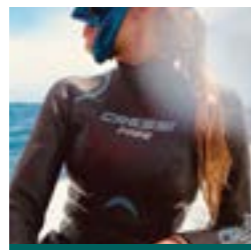

FREEDIVING WETSUITS & NEOPRENE

Freediving Wetsuits	269
Rash Guards	275
Gloves	277
Socks	278



BUOYS & WEIGHTBELTS

Buoys	279
Weight Belts	280



FREEDIVING BAGS

Dry Bags	282
Bags	284

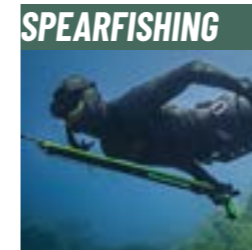

SLING SPEARGUNS

Sling Spearguns	291
Shafts	300
Tips	302
Elastic Bands	303
Reels	305
Accessories	306
Bags	307

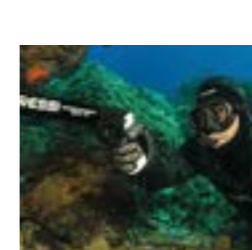

PNEUMATIC SPEARGUNS

Pneumatic Spearguns	308
Shafts	311
Speargun Accessories	312
Comparative Chart	314
Pole Spears	316
Pole Spear Accessories	318



TORCHES & KNIVES

Torches	321
Knives	323
Knives Spare Parts	331



BRAND SUPPORT

Product Displays	333
Flags	336

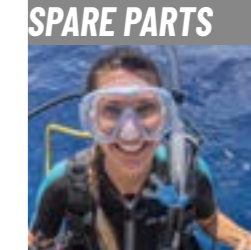

SPARE PARTS

Spare Parts	339
Dimension Chart	340

-	
360 REGULATOR BAG	87
A	
A1	145
AC2 / COMPACT	78
AC2 / COMPACT + OCTOPUS COMPACT	80
AC2 / XS2	79
AC25G / COMPACT	76
AC25M	81
AC25M / MASTER CROMO	72
AIR	152
AIR CRYSTAL	152
ALLIGATOR	192
ALPHA ULTRA DRY	178
ALUMINIUM POLE SPEARE	317
AMERICA	267
ANTI-FOGS	173
ANTI-SLIP SOCKS 2.5 MM	217
APACHE	299
APNEA 3.5 MM	272
APNEA 5 MM	272
APNEA 7 MM	272
AQUARIDE	104
AQUAWING	97
AQUAWING PLUS	96
AVIATOR	99
B	
BAHIA FLEX 3 MM	201
BALEARI MD PHS 3 MM	214
BALEARI PHS 6 MM	212
BAND RUBBER TUBING	303
BCD ACCESSORIES	115
BCD SPARE PARTS	117
BCD TOOLS	118
BEANIE UNISEX	210
BIG EYES	165
BIG EYES & SUPERNOVA DRY	184
BIG EYES EVO & ALPHA ULTRA DRY	184
BIG EYES EVOLUTION	151
BIG EYES EVOLUTION CRYSTAL	148
BORG	324
BORG BLUNT TIP	191
C	
CALIBRO	144
CALIBRO & CORSICA	264
CALIBRO+	142
CARBON	94
CARTESIO	30
CHEROKEE EXO	294
CHEROKEE FAST	292
CHEROKEE POWER	291
CIRCULAR BAND Ø 13 MM	304
CIRCULAR BAND Ø 14 MM W/ WISHBONE	304
CIRCULAR BAND Ø 16 MM	304
CIRCULAR BAND Ø 16 MM W/ WISHBONE	303
CIRCULAR BAND Ø 18 MM W/ WISHBONE	303
COBIA	275
COMANCHE RAIL	298

COMBO BAG	228
COMMANDER EVO	93
COMPASS	59
COMPETITION THREADS	306
CONCH DYFIBER	277
CONSOLE CP2	58
CONSOLE CPD3	58
CONSOLE PD2	58
CONSOLE SPARE PARTS	62
CORFU	175
CORSICA	266
CUMMERBUNDS	116
D	
DESERT	194
DIGI	55
DIGI2	56
DIN ASSEMBLY	87
DIVE COMPUTER ACCESSORIES	60
DONATELLO	42
DONATELLO CONSOLE 2	44
DONATELLO CONSOLE 3	45
DRY BAG	224
DRY GARA BACKPACK	284
DRY GUN BAG	307
DRYSUIT UNDERSUITS	195
E	
ELETTRA	98
ELITE PROTECTIVE CASE	60
EYES EVOLUTION	257
EYES EVOLUTION CRYSTAL	150
F	
F-DUAL	155
F-DUAL & SUPERNOVA DRY	183
FAST 3 MM	198
FAST 7 MM	196
FG1	316
FG3	316
FIN BUCKLES	136
FIN SOCKS	217
FIN STRAP	136
FINESTRA DRY BAG	224
FINISHER	324
FISTERRA 8 MM	269
FLAG CRESSI	336
FLOAT ROPE	279
FOCUS	166
FREE FROG	135
FREEDIVING TRAINING BUOY	279
FROG	126
FROG PLUS	124
G	
GARA 2000 HF	246
GARA 3000 LD	245
GARA MODULAR	241
GARA MODULAR ASSEMBLY KIT	243
GARA MODULAR BLADES	243
GARA MODULAR FOOT POCKET	243
GARA MODULAR IMPULSE	240
GARA MODULAR IMPULSE TURBO	238

GARA MODULAR SET	242
GARA MODULAR SPRINT	132
GARA MODULAR SPRINT TURBO	130
GARA MODULAR TURBO FOOT POCKET	243
GARA PREMIUM BAG	286
GARA PROFESSIONAL LD	247
GARA PROFESSIONAL SET 3.0	249
GARA TURBO CARBON	236
GENIUS DIVE CONSOLE BAG	60
GIANT	323
GIOTTO	46
GIOTTO CONSOLE 2	47
GOA	34
GORGONA	227
GORILLA PRO XL	283
GRINGO	267
GRIP BLUNT TIP	191
GRIP SPEAR BLACK	329
GRIP SPEAR TITANIUM	328
H	
HAND PUMP	312
HANDEX HOOD	210
HEX GRIP	277
HIGH STRETCH 2.5 MM	211
HIGH STRETCH 3.5 MM	211
HIGH STRETCH 5 MM	211
HIGH-TENACITY	305
HUNTER GLOVES	277
HUNTER RASH GUARD	276
HUNTER SOCKS	278
HUNTER SWIVEL SNAP CLIP	279
I	
IBIZA 3 MM	214
INT ADAPTOR	87
INTERFACE	53
INTERFACE BT	52
ISLA 5 MM	213
ISLA 7 MM	213
ITACA ULTRA DRY	176
J	
JUMBO TROLLEY	219
K	
KAI	326
KAI MINI	326
KILLER	327
KING	230
KNIVES SPARE PARTS	331
L	
LAMPUGA 3 MM	270
LAMPUGA 5 MM	270
LEONARDO	48
LEONARDO CONSOLE 2	49
LIBERTY DUO SPE	159
LIBERTY QUATTRO SPE	161
LIBERTY SPE	158
LIBERTY TRISIDE SPE	160
LIBRA BALLAST WEIGHT BELT	115
LIDO 2 MM	206

LIDO LONG 2 MM	202
LIGHTWING	101
LINCE	164
LINE CUTTER	192
LONG FIN SET BAG	286
LUMIA+	189
M	
MACH SPEAR HEAD	311
MAGNETIC OCTOPUS HOLDER	88
MANTA	28
MARSEILLAISE WEIGHT BELT	280
MASK SPARE PARTS	170
MATRIX	163
MAUI SAF	128
MAYA 2.5 MM	200
MC9 / COMPACT	77
MC9-SC	81
MC9-SC / COMPACT PRO	74
MED X 2.5 MM	203
METIS	260
MICHELANGELO	38
MICHELANGELO CONSOLE 2	40
MICHELANGELO CONSOLE 3	41
MINI SPEAR HEAD	311
MINI SPG	59
MINICONSOLE 2	59
MINIMA	168
MINORCA LONG 3 MM	215
MINORCA SHORT 3 MM	215
MOBY	220
MOBY 5 HYDRO	220
MOREA 3 MM	199
N	
NANO	146
NEON	32
NEPTO	232
NEREUS	28
NET BAG	228
NIKITA	307
NIKITA XL	307
NORGE	325
NYLON WEIGHT BELT W/ HARD PLASTIC BUCKLE	116
NYLON WEIGHT BELT W/ METAL BUCKLE	116
O	
OCTOPUS BALANCED MG	82
OCTOPUS COMPACT	82
OCTOPUS COMPACT PRO	82
OCTOPUS DRY	223
OCTOPUS XS2	82
OPTICAL LENSES	172
ORCA	323
OTTERFLEX 5 MM	197
OUTDOOR FEATHER	336
P	
PACIFICO	167
PALMA LT 3 MM	216
PALMA ST 3 MM	216
PARALLEL BAND Ø 16 MM	304

PATROL	106
PENTA+	162
PERLA	263
PERLA & MEXICO	264
PIOVRA XL	285
PIPER	221
PLAYA FLEX 3 MM	205
POLE SPEAR POWER BAND	318
POLE SPEAR TIPS	318
PONY TAIL MASK STRAP COVER	173
PREDATOR	327
PRESSURE GAUGES	312
PRO LIGHT	127
PRO STAR	134
PRODUCT DISPLAYS	333
Q	
QUANTUM	138
QUARTZ	105
QUARTZ ESSENCE COLD PACKAGE	114
QUARTZ ESSENCE PACKAGE	113
QUICK-RELEASE WEIGHT BELT	280
R	
REACTION EBS	122
REACTION PRO	133
REELS	305
REGULATOR HOSES	88
REGULATOR MAINTENANCE KITS	90
REGULATOR SPARE PARTS	89
REGULATOR TECHNICAL DRAWINGS	90
REGULATOR TOOLS	91
ROATAN	225
RUBBER FIN KEEPER	250
S	
SAETTA BLACK	309
SAETTA BLACK W/ POWER REDUCER	309
SAETTA PRO	308
SARAGO 7 MM	216
SCORPION	100
SEA LION	27
SEPIA 7 MM	271
SF1	154
SHAFT 17-4 PH BOT. FLOPPER Ø 6 MM	300
SHAFT 17-4 PH BOT. FLOPPER Ø 6.5 MM	300
SHAFT 17-4 PH BOT. FLOPPER Ø 7 MM	300
SHAFT 17-4 PH NOTCHED Ø 6.5 MM	301
SHAFT 17-4 PH Ø 7.5 MM	311
SHAFT INOX FINNED Ø 7 MM	300
SHAFT INOX FINNED THREADED Ø 7 MM	301
SHAFT INOX THREADED Ø 8 MM	311
SHAFT LOADER	312
SHAFT PR80 THREADED Ø 8.0 MM	311
SHAFT REFLOATER	312
SHAFT SLIP TIP	302
SHAFT ST. STEEL NOTCHED Ø 6.5 MM	300
SHAFT ST. STEEL NOTCHED THREADED Ø 7 MM	301
SHAFT TIPS	302

SHOCK CORDS	306
SIMPLY MASK STRAP COVER	173
SKIN	207
SKORPION	330
SL STAR	310
SNORKEL SPARE PARTS	185
SOLID	108
SOLO FLEX 7/5	209
SOLO HOOD 2 MM	210
SOLO HOOD 3 MM	209
SOLO HOOD 5 MM	209
SPEARGUN OIL	312
SPIDER MESH BAG	192
START	109
START PRO 2.0	107
START-ER PRO PACKAGE	113
STICKERS	337
SUPERNOVA DRY	179
SUPEROCCHIO	262
SUPERTOTEM	328
T	
T10-SC CROMO	81
T10-SC CROMO / GALAXY	68
T10-SC CROMO / GALAXY-R	66
T10-SC CROMO / MASTER CROMO	71
T10-SC PVD / MASTER	70
TAO	181
TAO DRY	180
THOR EBS	120
TOKUGAWA 2-PCS 2 MM	273
TOKUGAWA 2-PCS 3.5 MM	273
TOKUGAWA 3 MM	274
TORPEDO PRO BUOY FLOAT	279
TORTUGA 2.5 MM	204
TRAVEL PATROL PACKAGE	114
TRAVELIGHT	102
TROPICAL 2 MM	211
TUNA DRY	222
U	
ULTRA STRETCH SOCKS 1.5 MM	217
UTILA	226
V	
VIGO	330
W	
WATCH SPARE PARTS	61
WEIGHT BELT KEEPER	280
WISHBONES	306
Y	
YUMA FAST	296
Z	
Z1	156
ZEUS	140
ZS1	157
ZS1 & CORSICA	265

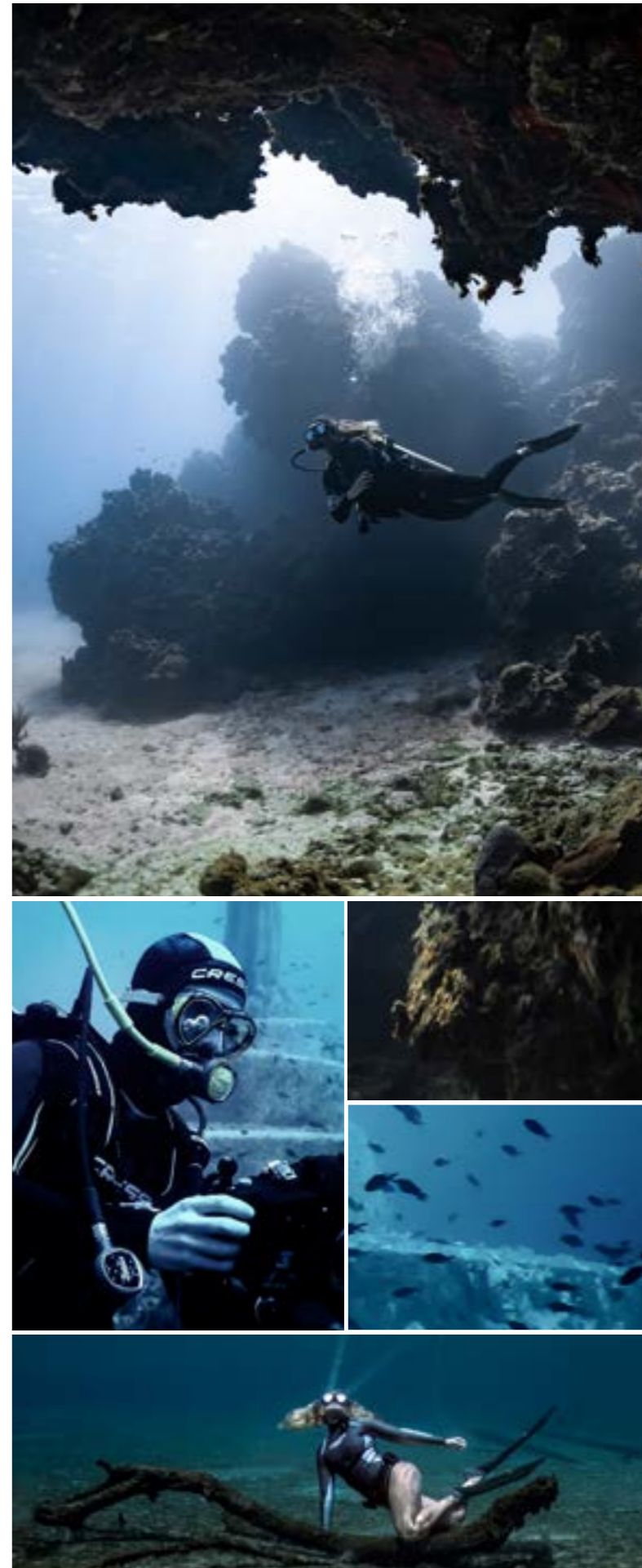

JOIN THE CRESSI FAMILY

Diving, Snorkeling and Water Sports are not 3%, 5% or 10% of our business. They are 100% of our business. We are focused only on water related sports.

We have been doing this, in the bay of Portofino, since 1946 and **this is what makes Cressi different.**

SINCE 1946

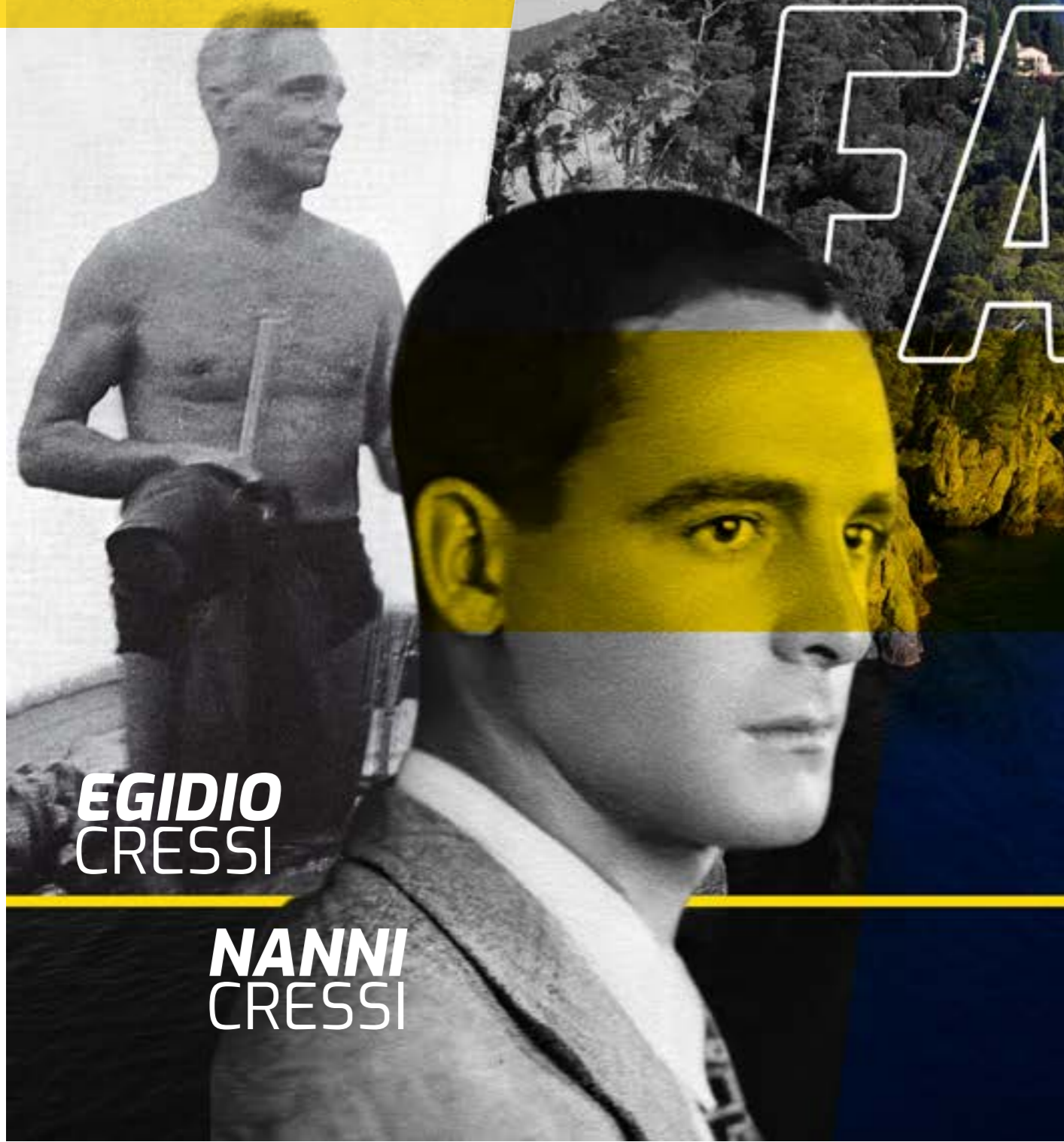

EGIDIO
CRESSI

NANNI
CRESSI



ANTONIO CRESSI & MARCO CRESSI

WE USE & TEST OUR PRODUCTS

OURSELVES
OURSELVES
OURSELVES
OURSELVES
OURSELVES
OURSELVES
OURSELVES
OURSELVES

WE ARE FAMILY

1930



1938
Brothers Egidio and Nanni Cressi start to handcraft the first masks and spearguns. These are the origins of Cressi, the oldest scuba diving equipment company worldwide.



1940

1943
The first Cressi mask, The Sirena, was hand crafted in 1943. It remained in the catalogue, with various updates, for more than 30 years.

1946
The Cressi company is officially founded in Genova, Italy.

1947
In 1947 the first oxygen rebreather was produced; Aro AR47. It was already highly advanced and fitted with sophisticated technical solutions, like the condensation receptacle.



Pinocchio



1950

1952
Pinocchio Mask, which makes equalization possible. It is a major innovation in the early '50s. It is the most famous and most sold mask in the world's history, and it is still included in the catalogue.



1953
Rondine Fins - Also in the field of fins, Cressi invented the model that has inspired all other manufacturers, the first floating model in the world.

1957
Cressi athlete Mario Catalani wins the first spearfishing World championship and get the gold medal in Jugoslavia.



1960

1965
Cressi opened one of the first workshops that specialized in producing optical masks. Thanks to Cressi, even people with visual defects could now get full enjoyment of the underwater universe.



1970

1970
Equi-vest - In 1970, Cressi was the first manufacturer in the world to produce Equi-Vest, a futuristic jacket that became one with the scuba tank, supplied by a hose that drew air directly from the first stage. This was the first incarnation of the modern BC.

1970
Rondine L long fins - The world leader of molding rubber fins, Cressi developed the Rondine L long fins, which enabled Jacques Mayol to go onto achieve his astonishing freediving records.

1979
Fins range - Alongside the various rubber fin models, a futuristic model was presented with a reinforced nylon blade, called the Rondine Gara, a fin that thirty years down the line is still going strong, and has been adopted by world class freedivers and spearfishermen the world over.



/ HISTORY



1980

1983
Jacques Mayol, the first man in the world to challenge the 100m barrier. He reached a depth of 105 meters. The episode has gone down in history, the record was obtained in the waters of the island of Elba in 1983.

1988
Apache Arbalète - Cressi produced a complete range of Arbalète spearguns to join the pneumatic guns, called the Apache, which very soon became the Champion speargun in the world.

1989
Cressi athlete Renzo Mazzarri wins the spearfishing world title in Italy.



1990

1990
Cressi continues its international expansion and the products are by now distributed in over 90 countries world wide.

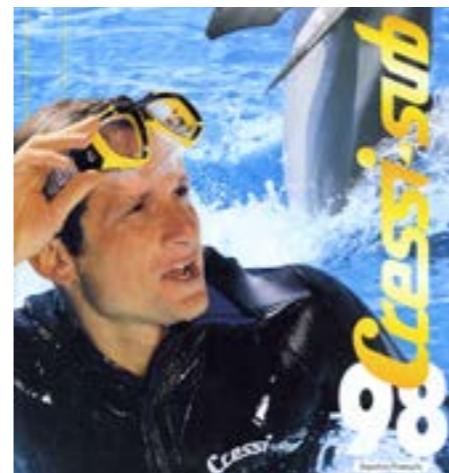

1999
Cressi Athlete Umberto Pelizzari sets the freediving "No Limits Absolute Variable Weight" World Record in Portofino (Italy) reaching the depth of 150 meters.



2000

2000
Big Eyes was the first mask in the world with raked lenses in an upside-down teardrop shape, an innovative form that gives the diver a complete view of all the equipment worn. They became the most widely copied and imitated mask in the world, a gratifying appreciation of how far ahead Cressi is in the design of its products.



2010

2011
The Leonardo dive computer watch is introduced, the first of the products designed in-house by Cressi Elettronica in order to guarantee optimum quality, safety and reliability.

2013
The French freediving champion Guillaume Néry becomes a Cressi product endorser. The Giotto dive computer watch is introduced; it processes the data from repeat multi-day dives and dives with gas mixtures and also benefits from the Cressi RGBM algorithm. The Tracina wetsuit for spearfishing is introduced in a new and exclusive camouflage Dark Digital Specter Pat Cressi.

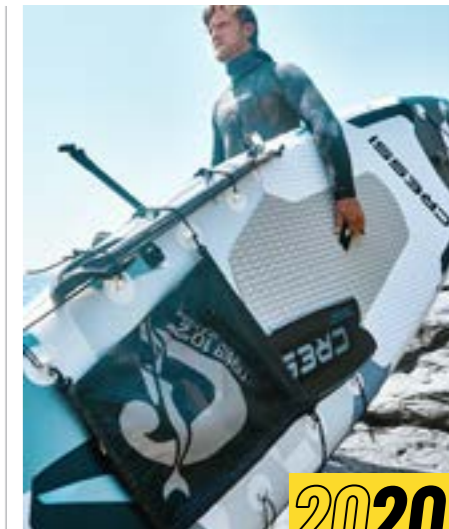

2020

2021
Hydrosports is the result of Cressi's experience, consisting of tradition, innovation and quality, since 1946. With its close relationship to the sea environment, the Cressi team has been able to develop this new collection in response to the direct needs it encountered in practice and through water tests on its products.



TODAY

The Cressi company is still entirely owned by the Cressi family, which carries on with the same passion, the work started by brothers Nanni and Egidio Cressi. Its spirit lies in the manufacturing tradition, with a clear preference for the conception and realization of its products in-house, from the initial design through to the smallest details. Cressi focuses on those who love all facets of the aquatic world. The company has never exaggerated with successful products on the market, but has instead always invested in research and development to the benefit of quality and reliability, the evolution of materials.

OUR NUMBERS

- 75 YEARS OF EXPERIENCE
- 7 BRANCHES AROUND THE WORLD
- SALES IN 100 COUNTRIES WORLDWIDE
- 100 PATENTS
- 11 TIME SPEARFISHING WORLD CHAMPION
- 7.000 REFERENCES
- UNIQUE STYLE

LIGURIA. OUR LAND, OUR SEA

It was to fish in the depths of Portofino and San Fruttuoso that, just before the Second World War, a group of friends thought of new equipment. Situated between the French border and Tuscany, Liguria is one of the smallest regions in Italy. The Italian riviera is reflected in the blue Mediterranean Sea, but is also surrounded by mountains that drop sheer into the sea. Vegetation forms the backdrop to some of the country's most popular and well-known seaside resorts.

The coasts are generally high, rocky, jagged, especially in the Riviera di Levante, while in the Ponente there is an almost perfect alternation between sheer cliffs and sandy beaches.

It couldn't be any other way, the strong passion for the sea finds its place in a unique setting with depths to explore.



"THE SEA IN LIGURIA, ESPECIALLY AROUND THE PORTOFINO PROMONTORY, IS EXTRAORDINARILY BEAUTIFUL AND, WHAT'S MORE, ACCESSIBLE WITHOUT TOO MANY PROBLEMS. THIS HAS PLAYED AN IMPORTANT ROLE IN THE BIRTH AND GROWTH OF A DIVING EQUIPMENT CENTRE IN THESE PARTS."

Antonio Cressi

" I'M PROUD TO STILL MANUFACTURE IN ITALY OUR MOST STRATEGIC PRODUCTS."

ANTONIO CRESSI



THE CRESSI HEADQUARTERS

In 1989, the company was enlarged, moving it to Via Adamoli, along the Bisagno valley in Genoa. And then came the electronics department. Since 2008 we have created a research and development department for this sector and so we produce directly the many control instruments that are now used during diving. With 150 employees and

seven branches, Cressi is a world leader in the production of diving equipment, innovation, and development with exports accounting for 80% of turnover.

BUT THE ONLY ONE STILL RUN BY A FAMILY

WHERE WE ARE

WORLDWIDE

Our headquarters is based in Genoa, and we also have seven branches: USA, Mexico, Brazil, France, Spain, China, and Thailand.

70% of our products are made in Italy in our own factory, in Genoa. 10% of our products are made in our own production facility in Hungary and the remaining 20% is sourced from selected high-quality suppliers from Asia.

We have around 10,000 shops all over the world, and our products are sold in over 100 countries.

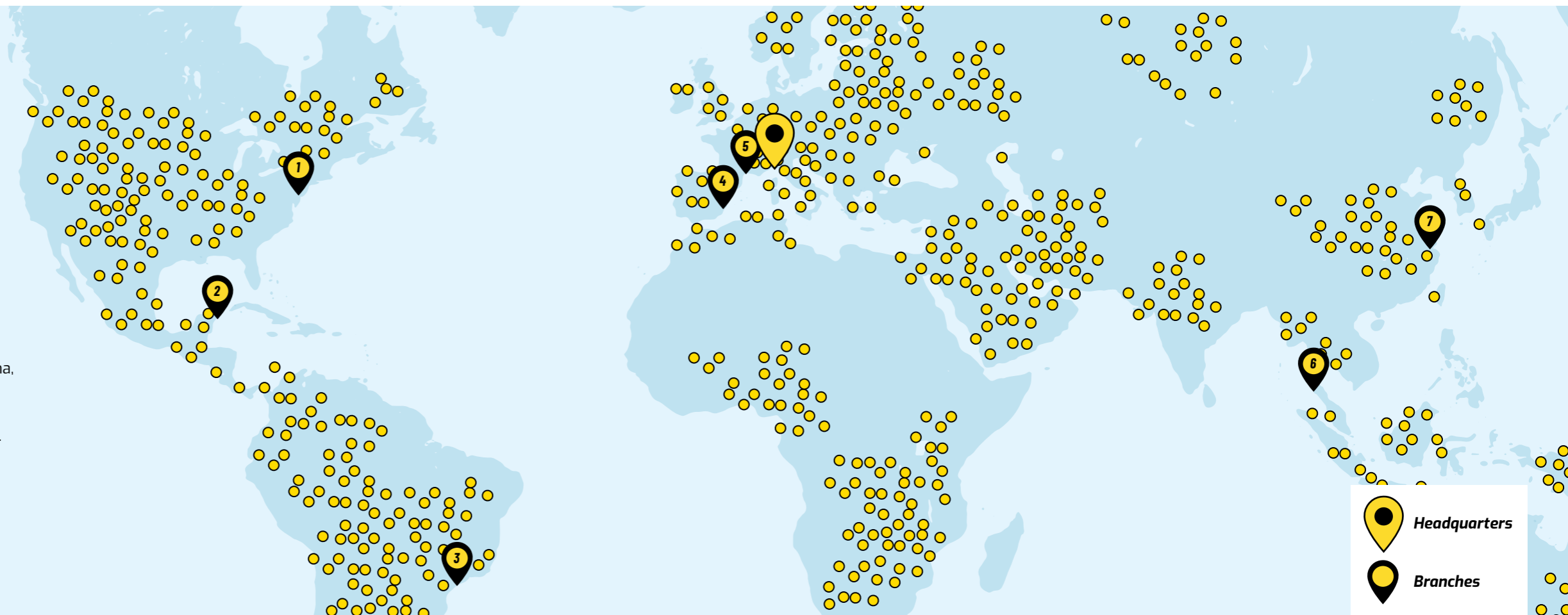

Headquarters

Branches



CRESSI ITALY HEADQUARTERS

Cressi Sub S.P.A.
Via G. Adamoli, 501
16165 Genova - Italy
Tel. +39 010 830 791



CRESSI U.S.A.

Cressi Sub U.S.A.
3 Rosol Lane, Saddle Brook - NJ 07663 - USA
Phone: (800) 338 9143
Phone: (201) 594 1450



CRESSI MEXICO

Cressiwater S.A.P.I De C.V.
Central de Abastos, Carretera - Cancun-Aeropuerto km 17, Cancun Quintana Roo. C.P.77565 - Mexico, VAT NO.CRE161110812
Phone: +52 1 554 162-2052



CRESSI BRASIL

Cressi Brasil COM. MAT. ESP. LTDA
Avenida Padre Anchieta, 175 - Jordanópolis, São Bernardo do Campo SP, 09891-420
CNPJ: 35.112.958/0001-59



CRESSI ESPAÑA

Cressi-Sub España S.A.
NIF: A60130978 - C/Castellassa, 24 Nave 3, Poligono Can Petit 08227 Terrassa Barcelona - Spain
Tel. +34 937 841 888



CRESSI FRANCE

Cressi Sub France
Espace La Gaude, 9565 Route De Saint Laurent 06610 La Gaude - France
Tel. +33 049 329 0318



CRESSI THAILAND

Cressi South East Asia Ltd
135/6-7 Moo 4 - Patak Road, Tambon Rawai Amphur Mueang, Phuket - Thailand 83130
Mobile: +66 (0) 643971234



CRESSI CHINA

Cressi China Watersports Products Co.,Ltd
No.8 Nanhe Road Kunshan City - Jiangsu province, China
Phone 86 0512 3668 0846#812

OFFICIAL WEB SITE

CRESSI.COM



RESERVED PROFESSIONAL AREA /// DOWNLOADING AREA

Visit www.cressi.com and access the Professional Area. The Professional Area is only dedicated to Cressi Authorized Dealers. In order to access it, you will need a user name and password that will be supplied to you by The Cressi America Company.

LOGIN : Username and password



1. GO www.cressi.com
2. LOGIN PROFESSIONAL AREA:
 - LOGIN AND PASSWORD: Supplied to you by The Cressi America Company.
 - FORGOT PASSWORD? Enter your username and we will send a reset password link to the email on your account.

Warning: This area of the Cressi-sub-website and its contents are exclusively reserved for Cressi Authorized Dealers. Technical documentation will be available only for Cressi-sub Service Centers.

DOWNLOAD

ALL CRESSI DOCUMENTS YOU NEED, READY ON YOUR: **CRESSI PROFESSIONAL AREA**



B2B : RETAILER PLATFORM

[/ B2B.CRESSIUSA.COM](http://B2B.CRESSIUSA.COM)

THE EXCLUSIVE AUTHORIZED DEALER ONLINE WEBSITE

WHAT IS IT?

We have developed an online order system, which means that you can now place your order at Cressi as you shop on any e-commerce website.

HOW DOES IT WORK:

Authorized and in coordination with your Territory Sales Manager, you will receive an invitation email from b2b@cressiusa.com

HOW TO ACCESS:

1. Contact your Cressi Sales Representative or Cressi USA office and ask for your credentials
2. Go to b2b.cressiusa.com, click on dealer area, type your credentials and Login to place your order

THE BENEFITS:

- Enhanced Experience To Order Easy And Fast
- Direct Access At Any Time To Order Product
- Real-Time Updates: Homepage Carousel Highlighting New Products And Current Promotions
- Stock Availability: Access To Real-Time Inventory Quantities You Have
- Direct Access At Any Time to Order Products

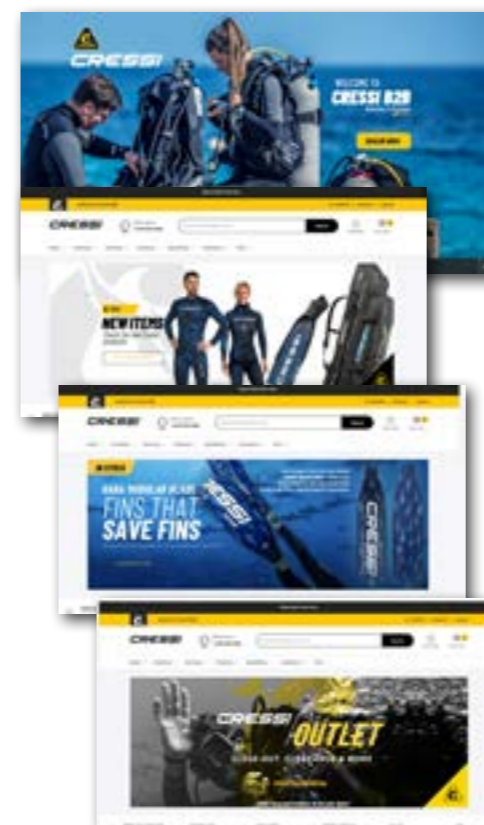

PIM (PRODUCT INFORMATION MANAGEMENT)



1. Go to www.cressi.com/cressiusedc **THE CRESSI'S PIM IS THE CENTRAL REPOSITORY OF ALL OF THE INFORMATION REGARDING THE PRODUCTS.**

2. Select the usa digital catalog
The Digital Catalog will help you to quickly find what you need, increasing your knowledge and experience. It is made to share all the possible information of a product, even images, videos, user guides, advertising material.

3. Explore product profile
 - Do you need an image of a product? Access the Digital Catalog and download it.
 - Do you need to know the lift capacity of a Cressi BC? Search on the Digital Catalog and you will find it.
 - Where are the fins size conversions charts? The answer is on the Digital Catalog.
 - Do you need the part number for a replacement part for the Cressi product? The Digital Catalog is made for it.
 - Do you need data for your e-commerce store? Just download them from the Digital Catalog.

POWERED BY: **SALSIFY**

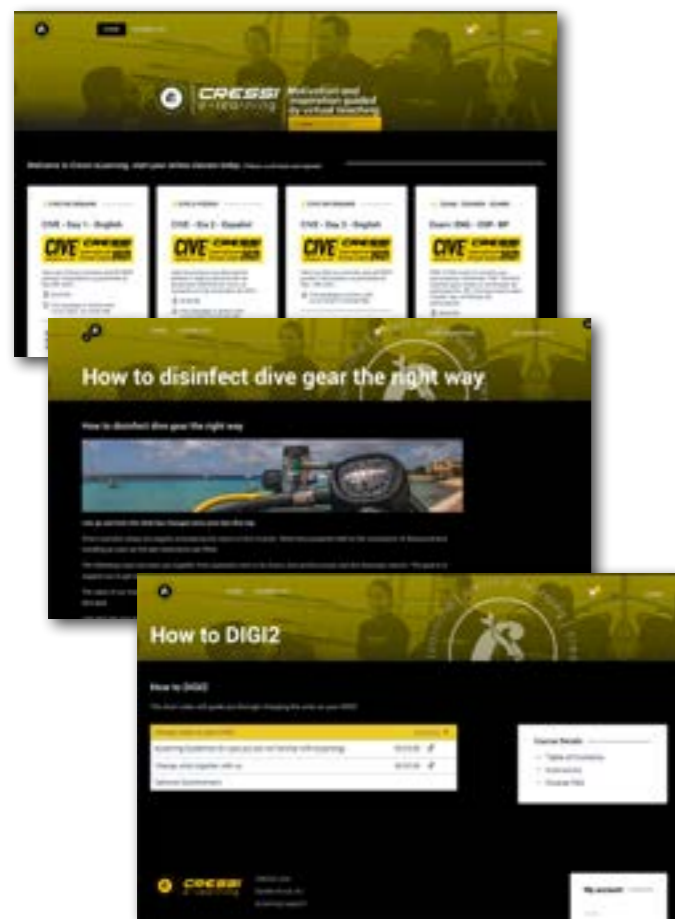

E-LEARNING PROGRAM

/ CRESSI LMS (ONLINE E-LEARNING MANAGEMENT SYSTEM)

Bringing all things Cressi to you in a simple and easy to access way. The E- Learning Management system is made to educate our dealers on a wide range of topics from product, classes and certifications, all while in the comfort of your home or shop!

CRESSI.MCLMS.NET

**REGISTER FOR FREE AND
START LEARNING ONLINE TODAY**

/ BLOG.CRESSI.COM



In 2020, Cressi will launch the Cressi CO-OP JOURNAL, where The Dive Community near Cressi will share awesome news and contents.

It will have 4 divisions:

- **FROM THE FIELD**
From the sea of Liguria where Cressi had its beginnings to the oceans of the world, Cressi celebrates its passion for the underwater world
- **WHAT'S NEW AT CRESSI**
Our latest advances in gear technology, product design, software innovations and infrastructure
- **WHAT'S NEW AT CRESSI**
Our lifestyle ambassadors live their passion for the ocean and pursue their dreams every day
- **ECO-NEWS**
Cressi is committed to doing business and creating products that contribute to a sustainable future for our customers and the planet.
- **SPEARFISHING**

CRESSI BLOG

WHAT'S NEW AT CRESSI



COMMUNITY



SOCIAL MEDIA

f FACEBOOK OFFICIAL CRESSI PAGE
cressigear 232.823 Followers

f FACEBOOK OFFICIAL SPEARFISHING PAGE
cressi.spearfishing 185.588 Followers

f FACEBOOK OFFICIAL HYDROSPORTS PAGE
cressi.hydrosports

Instagram OFFICIAL PAGE
cressi1946 179.000 Followers

YouTube OFFICIAL CHANNEL
Cressi 8.270 Subscribers

in LINKED-IN OFFICIAL PAGE
Cressi 1946

Twitter OFFICIAL TWEET
@Cressitaly

2021 SPECIAL MEDIA PROJECTS

/ SHARK WEEK 2021



- JULY 11- 16**
SHARK WEEK WITH JOSH GATES
- JULY 11- 10PM**
JACKASS SHARK WEEK
- JULY 11/ DISCOVERY+ EXCLUSIVE**
SHARKBAIT WITH DAVID DOBRIK
- JULY 16- 8PM**
NINJA SHARKS 2: MUTANT RISING
- JULY 14- 10PM**
RETURN TO LAIR OF THE GREAT WHITE

Shark Week is seven-day marathon documentation about sharks that airs annually on Discovery Channel since 1988. Every year it features some popular celebrities who go underwater paying a visit to the apex predator. Beginning this Sunday and continuing through next weekend, Discovery Channel's Shark Week is an annual, Jaws-dropping spectacle featuring more than 30 hours of original programming about one of nature's most feared predators.

- JULY 17 / DISCOVERY+ EXCLUSIVE**
ROGUE TIGER SHARK: THE HUNT FOR LAGERTHA
- JULY 11- 9PM**
TIFFANY HADDISH / SHARK WEEK
- JULY 13- 10 PM**
SPAWN OF EL DIABLO
- JULY 16- 9PM**
MONSTER SHARKS OF ANDROS ISLAND

/ CIVE 2021 FIRST CRESSI INTERNATIONAL VIRTUAL EVENT



CIVE is the Cressi International Virtual Event, an engaging online event where Our Technical Team, Product Designers, Sales Team, and Ambassadors will deliver all the news of Cressi for 2022. It is designed exclusively for Authorized dealers who can participate by registration.

For Cressi, it is important to achieve true communication with our coworkers and Dealers in real-time. Due to the present complications for traveling, the CIVE not only ensures that we maintain close, one-on-one contact with our Cressi Family, but it also allows us to learn more, submit questions and get in touch.

CRESSI BUYER'S GUIDE 2022 COLLECTION

Cressi's legacy of innovation began in 1939 with two brothers who shared a passion for the sea and a gift for technical design and working with their hands. Egidio and Nanni Cressi began by crafting masks and spearguns that would allow them to move and hunt more efficiently in the waters near their home. By 1946 their designs and products had become so popular they founded the Cressi company in Genoa, Italy. Today, although Cressi is a worldwide leader in water sports manufacturing, it is still wholly owned by the Cressi family, and the commitment to innovation is still in the company's DNA. It has a long history of groundbreaking product development, and has often been the first to bring product advancements to the market.

This history of innovation is also made possible by a commitment to manufacture products in Italy at the Cressi facility. An investment in the latest manufacturing equipment and more than 16,000 square meters of roofed space, and the ability to have the designing and manufacturing process happen side by side has led to the absolute highest standards for quality. It also allows Cressi engineers to quickly develop, test and incorporate the latest materials and technologies.

Innovations continue, the results today are the same as they were in the beginning, the most advanced and best made products in the world.

Cressi's experience and the Italian know-how gives life to the new 2022 collection.



Photo by: MathiaCoco

TAGHRID ALHOWISH

Dubai



[@taghridalhowish](#)

Taghrid Alhowish is a real sport lover, her passion for the sea led her to explore the underwater world and so she started scuba and free diving. She's a Reporter and Presenter at MBC in Dubai and part of the 'MBC in a Week' show, presenting a segment that is dedicated to art and culture.

ASIA BRYNNE

Hawaii



[@asiabrynne](#)

I picked up my first disposable film camera at the age of 8 and never stopped shooting. The ocean is a place away from all of the noise, where you don't have to use words, time doesn't exist, and you can share space with animals. Being underwater is a break from the busyness of life.

THE BUCKET LIST FAMILY

worldwide



[@thebucketlistfamily](#)

The Gee family, just a typical family working from all over the world as Family Travel Journalists! Their story began in 2015, when they decided to sell everything and leave home for a trip around the world. They started an Instagram and YouTube channel called, The Bucket List Family.

DANILO CALLEGARI

Italy



[@callegaridanilo](#)

He explored the most inhospitable places in the world, swam in the oceans and climbed the highest mountains, he crossed entire continents by bicycle... then four deserts and the largest glacier in Europe. His mission is to fuse air, land and water into a single adventure.

ERICKA CARRERA

Ecuador



[@erickacarrera](#)

30-years old Environmental Journalist. She spent over 8 years in the land of "down under", where she acquired a healthy lifestyle, passion for clean eating, and yoga. Resetting her life, she found purpose, rediscovered herself, and she fell in love with apnea.

CARLOS CORREA

Colombia



[@clubdelphinus](#)

I've always lived by the sea. It all started with my father's books and magazines about the underwater world, and then at the age of 9, I went scuba diving for the first time. It was fascinating and one of the best things (if not the best) that ever happened to me during my childhood.

IGOR D'INDIA

Italy



[@igordindia](#)

Igor has been able to combine his passion for outdoor adventure with his training in underwater filmmaking, camera drone pilot operation and advanced open water diving. He is deeply committed to participating in the global community that is fighting to protect the ocean.

REGINA DOMINGO

Mexico



[@regisunday](#)

Regina is part of the Nakawe project. The mission is to promote the conservation of critical ecosystems and species by working directly with communities to promote sustainable solutions to local environmental issues and educate local populations on the importance of biodiversity.

KRYSTAL DORN

USA



[@krystalklear](#)

Krystal moved to Hawaii, when she began photographing underwater and free diving. She is well known for capturing artistic images underwater, from mermaid photography to conservation awareness projects. Her mission is to help raise awareness for animal species.

CHRISTOPHER GILLETTE

USA



[@gatorboys_chris](#)

I'm born in Florida and have spent my life around the water. I love the freedom, weightlessness, and otherworldly views of diving. I try to use my passion to teach others about aquatic wildlife in the hopes they will learn to love them too, and ultimately help protect these fragile ecosystems.

SABRINA GIORDANO

Italy



[@__sabri__](#)

Sabrina is a young and passionate Yoga teacher, she loves to explore movements of the body in new positions and dimensions. On SUP board she discovered a new approach, where the focus becomes the balance between physical and mental status, breathing between water and sky.

KAYLEIGH & CAMERON GRANT

Hawaii



[@mermaid.kayleigh](#)

Kayleigh and Cameron are passionate divers who strive to educate and encourage people to protect our oceans. As a marine conservationist, Kayleigh understands the importance of educating people about ocean conservation. Through her work at One Ocean Diving, she's able to inspire people's in protecting the world's sharks and marine life.

PHILIP HAMILTON

UK



[@philip.hamilton.photography](#)

Philip Hamilton, filmmaker, photographer and author, is best known for his passion and dedication to ocean conservation. He has over thirty years diving and sailing experience and has documented most marine animals on the planet, from the majestic Blue whale to the smallest underwater critters.

SHAWN MAHONEY

USA



[@thebeaconscollective](#)

All of my first gear was Cressi, and most of it since has been. The early pioneers of freediving wore Cressi and I saw how successful they were so I said why not emulate what they do? I loved and still do my Cressi Gara 2000's. That's why it was a no brainer to say yea to being a Cressi ambassador.

THEO KNEVEL

Netherlands



[@theoknevel](#)

Theo is a scuba diving and advanced free diving instructor. He joined Cressi following a 10-plus-year career as a frogman in the Special Boat Service. He has been able to spread his passion for diving throughout the Caribbean. He is co-founder and chairman of the War Veterans Foundation.

LLUIS MASUET

Spain



[@masuleti_underwater](#)

In 2016, tired of the business world, he tried scuba diving and began to learn underwater photography, a combination that in just a few short years made this Barcelona citizen a renowned, award-winning photographer. Lluís currently travels all over the world capturing beautiful images.

BROOKS LAICH

USA



[@brookslaich](#)

He's a Canadian former professional ice hockey forward. He played over 750 National Hockey League games. Brooks is a multi-athlete and a sports lover, so what better way to kick off the day? A little snorkel session when the water is calm and fishes and turtles are active.

LEO MORALES

Mexico



[@leomoralesbuzo](#)

For many, scuba diving is an adventurous, recreational activity. For Cressi ambassador Leo Morales, scuba diving was therapy and the pathway to a second chance at life. After surviving a rare form of cancer, it was scuba diving that helped Leo to heal and find a deeper meaning into the purpose of his life.

PARIS NORRISS

Dubai



[@guyindubai](#)

Guy in Dubai is an adventure series hosted by Paris NorriSS. On the hunt for the biggest thrills and most extreme challenges, this entertaining series shows how the average person can learn and master the fastest and most furious adventure sports. Available on Amazon Prime.

ROBERTO OCHOA

Ecuador



[@robertoochoahe](#)

Roberto Ochoa is a Videographer for Planeta Azul, he started making wildlife videos at the age of 25 in the Galapagos Islands, Africa and North America. Beneath the world's waters lie landscapes, species, vegetation, and populations as diverse and splendid as those on land.

OCEAN RAMSEY & J. OLIPHANT

Hawaii



[@oceanramsey](#)

"Mr. and Mrs. Sharks". She is a marine biologist, shark and marine conservationist, professional freediver and scuba instructor, surfer, swimmer and professional model. Juan grew up surfing, he became a divemaster. He traveled the world with to help combat illegal fishing and whaling.

CRAIG O'CONNELL

USA



[@thesharkdoctor](#)

I'm from a small town located several hours from the ocean. But I always had a fascination with the ocean, a fascination that really came to fruition during my first shark encounter in the Florida Keys when I was 14. My free diving and scuba career began and has been growing ever since.

OUR AMBASSADORS

NATALIE PARRA

USA



@natalieparra

I'm from Southern California. I grew up playing in the ocean, but it wasn't until I was visiting the island of Oahu prior to moving there that I tried freediving for the first time. It felt like flying and I couldn't get enough of it. I started researching, taking courses and learning from fellow free divers.

CRAIG PARRY

USA



@craigparryphotography

It was his parent's gift of a disposable water proof camera that set him on the path to his passion. While most kids were reading comics, Craig was immersing himself in early editions of Australian Geographic. Finally the 35mm SLR set the course for Craig's future.

STEVEN PAYNE

USA



@sevenpayne

Steven grew up surrounded by open spaces, farms, and lakes; he loved exploring and seeing animals. His family moved to Florida, which cemented his love for the ocean. Steven is currently in the process of deploying artificial reefs: His nonprofit, The Reef Genesis Corporation, is his passion.

LUCA TIXI

Italy



@outdoorportofino

I was born and raised in Recco, at the time of high school, in a period of environmental militancy, the enlightenment arrives: I understand that my job will be to bring people into nature! After graduating in Marine Environmental Sciences at the University of Genoa, I founded Outdoor Portofino.

FEDERICO TRAVERSO

Italy



@skullphoto_aka_surfskull

He is a young Italian designer and collaborates with Cressi for many years. Federico is passionate about the sea in all its forms, practice surfing and freediving but instead of hunting, he prefers to take pictures and videos. He starts each day with a morning swim session in the sea.

NANJA VAN DEN BROEK

Netherlands



@nanjafreediver

Nanja van den Broek started freediving in 2001 and in her first competition she immediately set two national records. In 2015, she set a new world record in the discipline Variable Weight with a dive to -130 meters, this record is also her 30th national record.

ANDREW RAAK

USA



@raakbottomimaging

Passionate about all aspects of the marine environment, Andrew has worked as a dive professional for more than a decade. He has a degree in Marine Science, a captain's license and dive instructor certification. He has traveled the world photographing in amazing locations.

MARIO RIGBY

Turks&Caicos



@mariorigby

In 2018, Mario completed his crossing Africa journey, a two-year trek walking and kayaking from Cape Town to Cairo. This expedition allowed him to connect with communities and share their message and stories. His goal was to inspire people globally to get out, be brave, and see the world.

ARIANNA ROMERI

Italy



@ariannaromeri_art

I grew up surrounded by equipment and the perfume of neoprene, watching my dad dive and waiting for my moment. I signed up for a freediving course. It wasn't love at first sight; I learned to appreciate it when it became the key to getting to know myself, through its timing, calmness and sensitivity.

VOYAGES OF AGAPE

USA



@voyagesofagape

Agapé is a 1984 Tayana Vancouver 42', hull #93. "Agapé" means unconditional love. She is a true blue water cruiser, and has already seen much of Mexico, the South Pacific, and beyond. For us Agapé is home. She is a safe and trustworthy vessel that will ferry us to the less seen places of the world.

JASON WASHINGTON

Cayman islands



@caymanjason

For the past two decades, Jason has been a leader in the Cayman Islands water sports community. A 2017 International Scuba Diving Hall of Fame honoree, Jason's focus both locally and abroad has been on protecting the delicate marine life found in the waters of the C. Islands.

CHRISTINE WEST & ADAM MAIRE

Hawaii



@christine_regent_west

After working as scuba instructors, adding cold-water diving was the greatest modification to their portfolio. Working together diving on a project in Alaska opened their eyes wide to documenting undersea life in extraordinarily different environments from the warm waters where they began.

DIEGO SAAVEDRA

Chile



@diegoapnea

Freediving has taught me that the mind has no limits, that I can achieve whatever I set my mind to in life and how I must calmly accept all the things that I can't control. Thanks to this beautiful sport, I have been able to explore incredible places and meet wonderful people, who share the same love and passion for the ocean.

CHIARA SALOMONI

Italy



@chiaraphoto

I remember snorkeling all over the Mediterranean Sea, using my father's Cressi fins, which were oversized for my feet. I got into scuba and moved to the U.S. to follow my dream of becoming an underwater photographer, so that I would have the chance to be in the water as much as possible.

JACINTA SHACKLETON

Australia



@jacintashackleton

Jacinta Shackleton is a marine biologist and educator at Lady Elliot Island, located right on the Great Barrier Reef. You might recognize her name from her stunning work filming and photographing marine animals. Most notably, she is 1/50 people to have seen and filmed an Ornate Eagle Ray.

JONATHAN SCHUTTE

Cayman islands



@jonschutte

For as long as I can remember I have had a passion for traveling and telling stories. I love to create content and share my adventures. Through my project Nauti Nomad I hope to inspire you too to embrace life and pursue your passions, respect our planet and help each other!

SCUBA NATION. BILLY & MIKE

USA



@scubanationtv

Founded in 2008 by Billy Catoggio, ScubaNation is an Emmy Award Winning TV show dedicated to the exploration of our underwater world. Focusing on conservation and dedicated to the preservation of our oceans of life. Airs on Fox Sports Sun, NBC Sports Boston and we'll find it on Amazon Prime.

TARAH SWEENEY GEAR

USA



@tarahsweeney

Tarah describes herself as a simple person with a lot of love and passion. Photography is her passion and all this love started when her parents gave her an old Canon Rebel, since then she considers her cameras as an extension of herself, because they allow her to create what she sees and feels.



CRESSI, EQUIPMENT PARTNER OF Y-40®

In March 2019 Cressi officially became the partner of Y-40® The Deep Joy, the deepest pool in Europe. From that moment on, the recreational diving and freediving equipment available at Y-40® is provided by Cressi.

Y-40® The Deep Joy is the place where everything is possible, where you can live the most amazing aquatic experiences.

4,300 cubic meters of thermal water where there are free diving and scuba diving courses. It's a safe environment for professional exercises and scientific research, in addition to being an amazing film set and area for photographic and advertising services. Y-40® has an area of 21x18m; the maximum depth is 42.15 meters with different platforms at intermediate depths and caves for technical activities.

The deep pool can be visited, it is possible to walk in the transparent tunnel that crosses the structure, discovering the magic of this big human aquarium.

CRESSI SINCE 1948



@y40_thedeepjoy

CRESSI SCUBA DIVING 2022 COLLECTION

Cressi's scuba gear is recognizable all over the world, and it is one of the centerpieces of Cressi's main product catalog. Cressi is one of only a few companies in the world that manufactures and designs a full line of scuba equipment, from dive computers, regulators, BCDs and wetsuits, mask and snorkels to fins, plus a myriad of accessories. The blues of the ocean — from a bright, vivid blue to a deep cyan blue — will be the colors used to reflect the brand personality of Cressi's Scuba line. Cyan typically represents liveliness, youth and energy, so it's the perfect color for those who share a passion for the ocean, adventure, exploration and everything scuba.



SEA LION

| GOLDEN LABEL WATCH | AUTOMATIC WINDING
| 28.800 VIBRATIONS PER HOUR | 25 JEWELS
| EXCLUSIVE DEDICATED PACKAGING

The Sea Lion is the first Cressi Gold Label limited edition product and identifies a lifestyle belonging to the brand. It's the result of a perfect combination between Swiss precision and Italian design. It is suitable for all water sports, but also for the daily life of water lovers. The watch, water-resistant to 300 meters, has a stainless steel case, a sapphire crystal front and a transparent sapphire crystal back. The 120-click unidirectional rotating bezel is graduated to 60 minutes

with an anodized aluminium disc, to provide the diver with an accurate indication of dive times. The self-winding mechanical movement is customized for Cressi. The winding crown is at 4 o'clock, in steel with the Cressi brand engraved, in a functional position if wearing the wetsuit. Thus, the sturdy, comfortable and lightweight rubber strap allows precise adjustment of its length, so that it can be placed on the wrist above any sporting wear.

TECHNICAL FEATURES

- **CASE:** Bearing designTransparent sapphire-glass back, Winding crown
- **DIAMETER:** 44 mm
- **MATERIAL:** Steel
- **BEZEL:** Unidirectional rotatable 60-minutes graduated, Anti-scratch anodized aluminium, Numerals and graduations engraved
- **WINDING CROWN:** Screw-down, at 4 o'clock
- **CRYSTAL:** Scratch-resistant sapphire
- **WATER-RESISTANCE**
- Waterproof to 300meters/1,000 feet
- **MOVEMENT:** Automatic - mechanical - self-winding
- **CALIBRE:** ETA 2824-2
- **PRECISION:** -2/+2 sec./day
- **FUNCTIONS:** Center hour, minute and seconds hands, Instantaneous date with rapid setting, Stop-seconds for precise time setting
- **CORRECTOR:** Hour and minute hands adjustment, Calendar day adjustment
- **WINDING:** Bidirectional self-winding
- **POWER RESERVE:** Approximately 48 hours
- **STRAP**
- Soft and comfortable with non-slip texture
- **MATERIAL:** Black rubber
- **BUCKLE:** Steel safety buckle
- **DETAILS:** Highly legible display with luminescent material



300 M WATER-RESISTANCE



400 PIECES

Worldwide limited edition with a unique serial number



SILVER/BLUE



BLACK/BLACK



SILVER/ORANGE



PACKAGING

CODE	COLOR	CASE PACK
K5767020	Silver/Blue	10
K5767050	Black/Black	10
K5767085	Silver/Orange	10

WATCHES



SWISS
MANUFACTURE
QUALITY SINCE
1946

NEREUS

| 200 M WATER-RESISTANCE



BLACK/BLUE
SILVER CASE



BLACK/BLACK
BLACK CASE

TECHNICAL FEATURES

- Analog chronograph watch
- Proven Quartz mechanism for precise timekeeping

- » Stainless steel case
- » Unidirectional bezel
- » Crystal glass face and waterproof crown
- » Fluorescent hour/minute/second hands
- » Extra-large silicone strap



PACKAGING

CODE	COLOR	CASE PACK
XKS765052	Black/Blue	10
XKS765056	Black/Black	10

SPARE PARTS

CODE	PRODUCT
KZ764820	WATCHSTRAP - BLUE for NEREUS
KZ764855	WATCHSTRAP - BLACK/BLACK for NEREUS
XKZ000003	NEREUS BATTERY KIT w/O-RING (SONY SR621SW - 37.5 x Ø 1.0 mm)

MANTA

| 100 M WATER-RESISTANCE



BLACK/BLACK
BLACK CASE



BLACK/BLUE
BLACK CASE



BLACK/BLACK
SILVER CASE



BLACK/RED
SILVER CASE



BLACK/ORANGE
BLACK CASE

TECHNICAL FEATURES

- Ideal for diving

- » Stainless steel case
- » Unidirectional rotating bezel
- » Day date
- » Proven quartz mechanism for precise time keeping
- » Screw down crown waterproof
- » Mineral glass
- » Soft extra-large rubber strap accommodates exposure suits
- » Luminous dots



PACKAGING

CODE	COLOR	CASE PACK
XKS764750	Black/Black/Black	10
XKS7647520	Black/Black/Blue	10
XKS764755	Black/Black/Silver	10
XKS764758	Black/Red/Silver	10
XKS7647585	Black/Black/Orange	10

SPARE PARTS

CODE	PRODUCT
KZ764700	WATCHSTRAP - BLACK for MANTA
KZ764788	WATCHSTRAP - RED for MANTA
XKZ000001	MANTA BATTERY KIT w/O-RING (RENATA 371 - 36.0 x Ø 0.8 mm)

NINE COMPUTERS

SCUBA



8 YRS
MANUFACTURE
QUALITY SINCE
1966



- FREEDIVE FUNCTIONS
- USER FRIENDLY MENU
- LONG-LIFE BATTERY
- 4 OPERATIVE MODES
- MINERAL GLASS
- HEAVY DUTY CASE



CARTESIO

| SCUBA DIVING AND FREEDIVING WATCH COMPUTER

Cartesio has a diameter of only 48mm and a high contrast display of 35mm. It is a scuba diving/apnea watch-computer of extremely reduced dimensions. It is also an ideal watch for other underwater activities, thanks to the deactivation option of the "dive" functions

that avoids unnecessary alarms ringing while you're snorkelling or swimming. The display is made of mineral glass and the case is heavy duty with steel buttons that have an underwater resistance of up to 120m. Rubber wristband with stainless steel buckle.



BLACK BLACK METAL

Bluetooth
EXTERNAL
BLUETOOTH
DEVICE AVAILABLE



CODE	COLOR	CASE PACK
KS830050	Black/Black	4
KS830850	Black/Metal	4

TECHNICAL FEATURES

- High contrast display with extra large numbers
- Easy access menu
- 12/24 time format with calendar and seconds
- Precision stopwatch
- Second time setting
- Alarm clock
- Backlit display
- Surf time, desaturation and no fly time calculator
- Low battery indicator
- Units in Metric or Imperial system

AIR/NITROX PROGRAM

- CRESSI RGBM algorithm
- Complete diving data processor
- PPO2 1.2-1.6 BAR configuration
- It is possible to select hyper-oxygenated mixes during the dive phase. GA51 21-50% GA52 21-99%
- Graphic indicator of CNS toxicity level of oxygen
- Safety stop indicator
- Multiple level safety factor configuration
- Altitude configuration
- Algorithm for managing uncontrolled ascent
- Suitable for repeated, multiday decompression diving
- It is possible to alternate between nitrox and air diving even during desaturation
- Visualization of time at dive phase
- Deactivable Deep Stop alert
- Alarm in case of breach of ascent speed, decompression or PPO2
- It is possible to disable the ascent alarms
- Indicates time at dive phase
- Possibility of eventual total reset, useful for renting purposes

Planning: scrolling of no-decompression limits

FREE (APNEA) PROGRAM

- Display of all diving parameters, depth, temperature, dive calculator, maximum dive depth, dive time
- Length of surface interval between each dive
- Length of diving session
- Depth, dive time and surface interval alarms
- Recovery time alarm
- Visualization of time at dive phase

GAGE PROGRAM

- (without decompression calculator)
- Depth/temperature indicator
- Average depth
- Dive time in minutes and seconds
- Resettable depth stopwatch
- Visualization of time at dive phase

OFF MODE

- Sensors disabled for snorkelling/swimming activities

LOGBOOK

- Up to 50 dives per category
- Optional INTERFACE
- With visualization of diving profile



OPTIONAL ACCESSORIES

| STRAP EXTENDER | SILICONE PROTECTIVE LENS | BT INTERFACE



ACCESSORIES

CODE	PRODUCT
KZ810000	STRAP EXTENDER for DIVE-WATCH COMPUTER - BLACK/BLACK
KS890000	SILICONE SCREEN PROTECTOR for DIVE WATCH
KS822001	BT INTERFACE for DIVE-WATCH COMPUTER
KZ700000	ELITE PROTECTIVE CASE for DIVE COMPUTER

SPARE PARTS

CODE	PRODUCT
KZ8230050	WATCHBAND - BLACK for CARTESIO
KZ820094	BATTERY KIT (CR2450 + O-RING) for CARTESIO/GOA/NEON/NEPTO
KZ805099	SCREWS w/ NUT (1 pair) for DIVE WATCH COMPUTER BAND



ELITE CASE INCLUDED

NEON

| SCUBA COMPUTER WATCH

Neon has a diameter of only 48 mm and a high contrast display of 37 mm. It is a scuba diving/apnea watch-computer of extremely reduced dimensions. It is also an ideal watch for other underwater activities, thanks to the deactivation option of the "dive" functions

that avoids unnecessary alarms ringing while you're snorkeling or swimming. The display is made of mineral glass and the case is heavy duty with steel buttons that have an underwater resistance of up to 120 m. PTU rubber wrist band with stainless steel buckle.



- » Algorithm for managing two different hyper-oxygenated mixes during the dive phase
- » Gas1 21-50% gas2 21-99%
- » Compact (patented) electronic module
- » User friendly menu
- » Long-life battery
- » 4 Operative modes



TECHNICAL FEATURES

- AIR/NITROX PROGRAM**
- CRESSI RGBM algorithm
 - Complete diving data processor
 - PPO2 1.2-1.6 BAR configuration
 - It is possible to select hyper-oxygenated mixes during the dive phase. GAS1 21-50% GAS2 21-99%
 - Graphic indicator of CNS toxicity level of oxygen
 - Safety stop indicator
 - Multiple level safety factor configuration
 - Altitude configuration
 - Algorithm for managing uncontrolled ascent
 - Suitable for repeated, multiday decompression diving
 - It is possible to alternate between nitrox and air diving even during desaturation
 - Visualisation of time at dive phase
 - Deactivable Deep Stop alert
 - Alarm in case of breach of ascent speed, decompression or PPO2
 - It is possible to disable the ascent alarms
 - Indicates time at dive phase
 - Device completely resettable, useful for renting purposes
 - **Planning:** scrolling of no-decompression limits
- FREE (APNEA) PROGRAM**
- Display of all diving parameters
 - Depth
 - Temperature
 - Dive calculator
 - Maximum dive depth
 - Dive time
 - Length of surface interval between each dive
 - Length of diving session
 - Depth, dive time and surface interval alarms
 - Recovery time alarm
 - Visualisation of time at dive phase
- GAGE PROGRAM (without Decompression calculator)**
- Depth/temperature indicator
 - Average depth
 - Dive time in minutes and seconds
 - Resettable depth stopwatch
 - Visualisation of time at dive phase
- OFF MODE**
- Sensors disabled for snorkelling/swimming activities
- LOGBOOK** up to 50 dives per category
- Optional **INTERFACE** with visualisation of diving profile

TECHNICAL FEATURES

- High contrast display with extra large numbers
- Easy access menu
- 12/24 time format with calendar and seconds
- Precision stopwatch
- Second time setting
- Alarm clock
- Backlit display
- Surf time, desaturation and no fly time calculator
- Low battery indicator
- Units in Metric or Imperial system



CODE	COLOR	CASE PACK
K5840020	Black/Blue	4
K5840050	Black/Grey	4
K5840055	Black/Black	4
K5840058	Black/Red	4
K5840067	Black/Green	4
K5840085	Black/Orange	4
K5840141	White/Lilac	4



OPTIONAL ACCESSORIES

| STRAP EXTENDER | SILICONE PROTECTIVE LENS | BT INTERFACE



ACCESSORIES

CODE	PRODUCT
KZ810000	STRAP EXTENDER for DIVE-WATCH COMPUTER - BLACK/BLACK
K5890000	SILICONE SCREEN PROTECTOR for DIVE WATCH
K5822001	BT INTERFACE for DIVE-WATCH COMPUTER
KZ700000	ELITE PROTECTIVE CASE for DIVE COMPUTER

SPARE PARTS

CODE	PRODUCT
KZ840020	WATCHBAND - BLACK/BLUE for NEON/NEPTO
KZ840050	WATCHBAND - BLACK/GREY for NEON
KZ840055	WATCHBAND - BLACK/BLACK for NEON/NEPTO
KZ840058	WATCHBAND - BLACK/RED for NEON
KZ840067	WATCHBAND - BLACK/LIME for NEON
KZ840085	WATCHBAND - BLACK/ORANGE for NEON
KZ840141	WATCHBAND - WHITE/LILAC for NEON
KZ841098	WATCHBAND - BLACK/GREEN for NEPTO
KZ820094	BATTERY KIT (CR2450 + O-RING) for CARTESIO/GOA/NEON/NEPTO
KZ805099	SCREWS w/ NUT (1 pair) for DIVE WATCH COMPUTER BAND

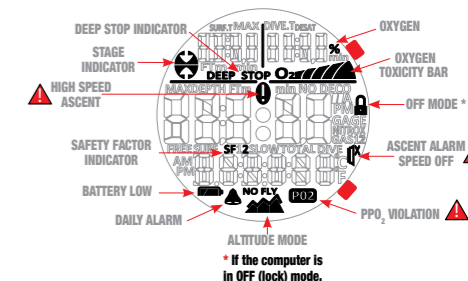

- MINERAL GLASS
- HEAVY DUTY CASE
- 4 OPERATIVE MODES
- FREEDIVE FUNCTIONS
- USER FRIENDLY MENU
- LONG-LIFE BATTERY

GOA

| SCUBA COMPUTER WATCH

The GOA has a diameter of only 48mm and a high contrast display of 35mm. It is a scuba diving/ apnea watch-computer of extremely reduced dimensions. It is also an ideal watch for other underwater activities, thanks to the deactivation option of the "dive" functions that avoids unnecessary alarms ringing while you're snorkeling or swimming.

The display is made of mineral glass and the case is heavy duty with steel buttons that have an underwater resistance of up to 120m. Rubber wrist band with stainless steel buckle. Plastic/Steel bezel and back cover.



CODE	COLOR	CASE PACK
K5820050	Black/Grey	4
K5820052	Black/Blue	4
K5820053	Black/White	4
K5820140	White/Pink	4
K5820150	White/Black	4

OPTIONAL ACCESSORIES

| STRAP EXTENDER | SILICONE PROTECTIVE LENS | BT INTERFACE



ACCESSORIES

CODE	PRODUCT
KZ810000	STRAP EXTENDER for DIVE-WATCH COMPUTER - BLACK/BLACK
K5890000	SILICONE SCREEN PROTECTOR for DIVE WATCH
K5822001	BT INTERFACE for DIVE-WATCH COMPUTER
KZ700000	ELITE PROTECTIVE CASE for DIVE COMPUTER

SPARE PARTS

CODE	PRODUCT
KZ820050	WATCHBAND - BLACK/GREY for GOA
KZ820052	WATCHBAND - BLACK/BLUE for GOA
KZ820053	WATCHBAND - BLACK/WHITE for GOA/KING
KZ820140	WATCHBAND - WHITE/PINK for GOA
KZ820150	WATCHBAND - WHITE/BLACK for GOA
KZ820094	BATTERY KIT (CR2450 + O-RING) for CARTESIO/GOA/NEON/NEPTO
KZ805099	SCREWS w/ NUT (1 pair) for DIVE WATCH COMPUTER BAND



TECHNICAL FEATURES

- 4-Programs dive computer
- Easier navigation menu due to two buttons only
- Easy to read information:** all data uppercase
- Diving data acquired 4 times faster
- Water temperature data acquired
- 12/24 Clock with calendar
- Clock timing visible during diving
- Second clock available on request
- Long-lasting battery:** cr2450 3v lithium
- Low battery indicator
- Battery replaceable by user
- AIR/NITROX PROGRAM**
- Cressi-wienke rbgm algorithm
- Graphic indicator of cns toxicity level of oxygen
- Safety stop indicator
- Multiple level safety factor configuration
- Altitude configuration
- Algorithm for managing uncontrolled ascent
- Switch between nitrox and air diving during desaturation
- Deactivable Deep Stop alert
- Alarm in case of breach of ascent speed, decompression or ppo2
- Ascent alarm be deactivate
- Surf, desaturation, no fly timer all displayed
- Suitable for repeated, multiday decompression diving
- Freediving (APNEA PROGRAM)**
- All parameters displayed:** depth, diving time, temperature, max depth
- Surf alarm customizable
- Depth alarm customizable
- Step alarm customizable
- GAGE PROGRAM**
- Depth / temperature indicator
- Average depth
- Diving time
- Resettable depth stopwatch
- OFF MODE**
- Sensors be disabled for snorkeling / swimming activities
- LOGBOOK** up to 50 dives per category
- Optional INTERFACE** with visualisation of diving profile



PACKAGING

- METAL BEZEL
- PROTECTION ALGORITHM FROM TARAVANA
- LONG-LIFE BATTERY
- 4 OPERATIVE MODES
- MINERAL GLASS
- SILICONE STRAP WITH POLYAMIDE CORE

KING

NEW 2022

| FREEDIVING COMPUTER WATCH

With a case diameter of only 48 mm and a highcontrast display of 35 mm, King is an extremely compact watch-computer specific for freediving. This innovative product boasts an algorithm developed in Cressi, which protects the freediver from the risk of Taravana, and a function that avoids the risk

of pulmonary edema. Mineral glass, heavy duty case with steel buttons for resistance to water pressure up to 120 m | 393 ft, metal bezel in AISI 316 steel with surface treatment and Inkfilled strap to prevent tears and breakage) with stainless steel buckle.



NEW
SILICONE STRAP WITH POLYAMIDE CORE

METAL BEZEL IN AISI 316 STEEL WITH SURFACE TREATMENT

SILICONE PROTECTIVE LENS INCLUDED



BLUE



BLACK



ORANGE



TARAVANA PROTECTION ALGORITHM



BLOODSHIFT PROTECTION ALGORITHM



TIDE LEVEL INDICATOR



SINGLE DIP LOGBOOK

CODE	COLOR	CASE PACK
K5842020	Blue	4
K5842050	Black	4
K5842085	Orange	4

ACCESSORIES

CODE	PRODUCT
KZ810000	STRAP EXTENDER for DIVE-WATCH COMPUTER - BLACK/BLACK
K5890000	SILICONE SCREEN PROTECTOR for DIVE WATCH
K5822001	BT INTERFACE for DIVE-WATCH COMPUTER
KZ700000	ELITE PROTECTIVE CASE for DIVE COMPUTER

SPARE PARTS

CODE	PRODUCT
KZ842050	SILICONE WATCHBAND - BLACK for KING
KZ842020	SILICONE WATCHBAND - BLUE for KING
KZ842085	SILICONE WATCHBAND - ORANGE for KING
KZ820094	BATTERY KIT (CR2450 + O-RING) for CARTESIO/GOA/NEON/NEPTO
KZ805099	SCREWS w/ NUT (1 pair) for DIVE WATCH COMPUTER BAND

TECHNICAL FEATURES

- High contrast display
- Easy access menu
- 12/24 time format with calendar and seconds
- Precision stopwatch
- Timer (countdown)
- Second time setting
- Alarm clock
- Backlit display
- Tide indicator
- Low battery indicator
- Metric or imperial units
- Long-lasting battery
- Sleep mode to increase battery life
- Battery replaceable by user
- FREE (FREEDIVING) PROGRAM**
- Taravana risk reduction algorithm with 8 levels
- Pulmonary edema risk reduction function with approach dive calculation
- Display of all diving parameters
- Depth
- Temperature
- Dip counter
- Maximum dive depth
- Dive time
- Length of surface interval between each dive
- Length of diving session
- Maximum descent and ascent speed indication
- Depth, dive time and surface interval alarms
- Recovery time alarm
- Hydration alarm
- Alarms that can be set at dive phase
- Fresh/salt water setting
- Lock mode for snorkeling or swimming activities
- LOGBOOK**
- Variable data logging interval
- Available during the diving session
- Indication of session parameters and of each dive
- INTERFACE**
- Optional with visualisation of diving profile

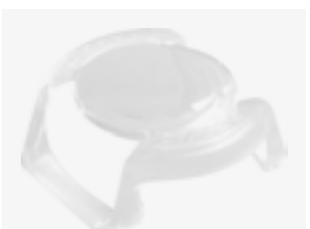

SILICONE PROTECTIVE LENS INCLUDED



ELITE CASE INCLUDED

- MINERAL GLASS
- HEAVY DUTY CASE
- PROTECTION ALGORITHM FROM TARAVANA
- EDEMA PROTECTION FUNCTION
- USER FRIENDLY MENU
- LONG-LIFE BATTERY



NEPTO

| FREEDIVING WATCH COMPUTER

With a case diameter of only 48 mm and a high-contrast display of 35 mm, Nepto is an extremely compact watch-computer specific for freediving.

This innovative product boasts an algorithm developed in Cressi, which protects the freediver from the risk of Taravana, and a function that avoids the risk of pulmonary edema. Mineral glass, heavy duty case with steel buttons for resistance to water pressure up to 120 m | 393 ft, rubber strap with stainless steel buckle.



BLUE



BLACK



GREEN

TECHNICAL FEATURES

- High contrast display
- Easy access menu
- 12/24 time format with calendar and seconds
- Precision stopwatch
- Timer (countdown)
- Second time setting
- Alarm clock
- Backlit display
- Tide indicator
- Low battery indicator
- Units in Metric or Imperial system
- Long-lasting battery
- Sleep mode to increase battery life
- Battery replaceable by user
- **Long-lasting battery:** CR2450 3V lithium

FREE (FREEDIVING) PROGRAM

- Taravana risk reduction algorithm with 8 levels
- Pulmonary edema risk reduction function with approach dive calculation
- Display of all diving parameters
- Depth
- Temperature
- Dive calculator
- Maximum dive depth
- Dive time
- Length of surface interval between each dive
- Length of diving session
- Maximum descent and ascent speed indication
- Depth, dive time and surface interval alarms
- Recovery time alarm
- Hydration alarm
- Alarms that can be set at dive phase
- Fresh/salt water setting
- Lock mode for snorkeling or swimming activities

LOGBOOK

- Variable data logging interval
- Available during the diving session
- Indication of session parameters and of each dive

INTERFACE

- Optional with Visualization of diving profile.

- » PROTECTION ALGORITHM FROM TARAVANA
- » EDEMA PROTECTION FUNCTION
- » USER FRIENDLY MENU
- » LONG-LIFE BATTERY



TARAVANA PROTECTION ALGORITHM



BLOODSHIFT PROTECTION ALGORITHM



TIDE LEVEL INDICATOR



SINGLE DIP LOGBOOK

CODE	COLOR	CASE PACK
K5841020	Blue	4
K5841050	Black	4
K5841098	Green	4



PACKAGING



OPTIONAL ACCESSORIES

| STRAP EXTENDER | SILICONE PROTECTIVE LENS | BT INTERFACE



ACCESSORIES

CODE	PRODUCT
KZ810000	STRAP EXTENDER for DIVE-WATCH COMPUTER - BLACK/BLACK
K5890000	SILICONE SCREEN PROTECTOR for DIVE WATCH
K5822001	BT INTERFACE for DIVE-WATCH COMPUTER
KZ700000	ELITE PROTECTIVE CASE for DIVE COMPUTER

SPARE PARTS

CODE	PRODUCT
KZ840020	WATCHBAND - BLACK/BLUE for NEON/NEPTO
KZ840055	WATCHBAND - BLACK/BLACK for NEON/NEPTO
KZ841098	WATCHBAND - BLACK/GREEN for NEPTO
KZ820094	BATTERY KIT (CR2450 + O-RING) for CARTESIO/GOA/NEON/NEPTO
KZ805099	SCREWS w/ NUT (1 pair) for DIVE WATCH COMPUTER BAND



ALGORITHM FOR MANAGING TWO DIFFERENT HYPER-OXYGENATED MIXES DURING THE DIVE PHASE. GAS1 21-50% GAS2 21-99% FREEDIVING FUNCTION



MICHELANGELO

| SCUBA DIVING AND FREEDIVING WRIST COMPUTER

Michelangelo has a high contrast display. It is a scuba diving/apnea computer. It is an ideal computer for other underwater activities, thanks to the deactivation option of the "dive" functions that avoids unnecessary alarms ringing while you're snorkeling

or swimming. The display is made of technical polyolefin and the case is heavy duty, with a steel button. The underwater resistance is up to 150 m. TPU rubber wristband with stainless steel buckle.



BLACK/BLACK

BLACK/METAL

BLACK/COPPER

Bluetooth
EXTERNAL
BLUETOOTH
DEVICE AVAILABLE

TECHNICAL FEATURES

- High contrast display with extra large numbers
- Easy access menu
- 12/24 time format with calendar
- High power backlit display
- Surf time, desaturation and no fly time calculator
- Low battery indicator
- Units in Metric or Imperial system
- AIR/NITROX PROGRAM**
- CRESSI RGBM algorithm
- Complete diving data processor
- PPO2 1.2-1.6 configuration
- It is possible to select hyper-oxygenated mixes during the dive phase. GAS1 21-50% GAS2 21-99%
- Graphic indicator of CNS toxicity level of oxygen
- Safety stop indicator
- Multiple level safety factor configuration
- Altitude configuration
- Algorithm for managing uncontrolled ascent
- Suitable for repeated, multiday decompression diving
- It is possible to alternate between nitrox and air diving even during desaturation
- Visualization of time while diving
- Deactivable Deep Stop Alert
- Alarm in case of breach of ascent speed, decompression or PPO2
- It is possible to disable the ascent alarms
- Possibility of eventual total reset, useful for renting purposes
- **Planning:** scrolling of no-decompression limits
- Maximum dive depth alarm
- FREE (APNEA) PROGRAM**
- Display of all diving parameters
- Depth
- Temperature
- Dive calculator
- Maximum dive depth alarm
- Dive time
- Length of surface interval between each dive
- Length of diving session
- Depth, dive time and surface interval alarms
- Recovery time alarm
- Visualization of time at dive phase
- GAGE PROGRAM**
- Depth/temperature indicator
- Average depth
- Dive time in minutes and seconds
- Resettable depth stopwatch
- Visualization of time at dive phase
- LOGBOOK**
- Up to 50 dives per category
- Replaceable protective display screen
- User-replaceable batteries
- Structural metal bezel that gives greater impact resistance
- Optional interface with visualization of diving profile

CODE	COLOR	CASE PACK
KS850050	Black/Black	4
KS850850	Black/Metal	4
KS850950	Black/Copper	4



OPTIONAL ACCESSORIES

| BT INTERFACE Bluetooth

ACCESSORIES

CODE	PRODUCT
KS851000	BT INTERFACE for DONATELLO/MICHELANGELO
KZ850098	PLASTIC SCREEN PROTECTOR for DONATELLO/MICHELANGELO
KZ700000	ELITE PROTECTIVE CASE for DIVE COMPUTER



SPARE PARTS

CODE	PRODUCT
KZ740055	WATCHBAND - BLACK for GIOTTO/DONATELLO/MICHELANGELO
KZ760525	SCREWS w/ NUT (2 pcs) for LEO/GIOTTO/MICH/DONATELLO BAND
KZ770094	BATTERY KIT LEO/GIOTTO/MICHELANGELO/DONATELLO
KZ901001	O-RING + CAP for BIG SCREEN COMPUTER



ELITE CASE INCLUDED



MICHELANGELO CONSOLE 2 NEW 2022

MICHELANGELO + PRESSURE GAUGE

The Michelangelo Console 2 has been designed to fit the Michelangelo dive computer in a modern console, robust and easy to handle. It features an easy-to-read Pressure Gauge that features a double scale in metric and imperial systems. The instruments are arranged on a slight tilt, which further improves the design and allows for greater

readability of the same. The use of advanced materials such as polycarbonate and Desmopan has reduced to a minimum thickness and weight, and the console reveals a surprising lightness, which translates into ease of use and minimum strain on the hose connection to the first HP the stadium.

TECHNICAL FEATURES

- Michelangelo 4 programs dive computer, 2 mixed gasses
- SPG global fluo in both metric and imperial systems and with fluorescent dial
- Housing in heavy-duty Desmopan material with hose clip
- HP hose
- **Dimensions:** 65 x 25 mm | 2.5 x 1 in
- **Weight:** 395 g | 13.9 oz



FLUO

» Units in Metric and Imperial system

CODE	PRODUCT	CASE PACK
K5852980	MICHELANGELO CONSOLE 2 (GLOBAL FLUO)	4

ACCESSORIES

CODE	PRODUCT
K5851000	BT INTERFACE for DONATELLO/MICHELANGELO
KZ850098	PLASTIC SCREEN PROTECTOR for DONATELLO/MICHELANGELO
KZ811001	PROTECTIVE CASE FOR DIVE CONSOLE

SPARE PARTS

CODE	PRODUCT
KZ760525	BATTERY KIT LEO/GIOTTO/MICHELANGELO/DONATELLO
KZ770094	SCREWS w/ NUT (2 pcs) for LEO/GIOTTO/MICH/DONATELLO BAND
KZ901001	O-RING + CAP for BIG SCREEN COMPUTER



MICHELANGELO CONSOLE 3 NEW 2022

COMPUTER + COMPASS + PRESSURE GAUGE

The Michelangelo Console 3 has been designed to fit the Michelangelo dive computer in a modern console, robust and easy to handle. It features an easy-to-read Pressure Gauge, that features a double scale in metric and imperial systems, and a Compass. The instruments are arranged on a slight tilt, which further improves the design and

allows for greater readability of the same. The use of advanced materials such as polycarbonate and Desmopan has reduced to a minimum thickness and weight, and the console reveals a surprising lightness, which translates into ease of use and minimum strain on the hose connection to the first HP the stadium.

TECHNICAL FEATURES

- Michelangelo 4 programs dive computer, 2 mixed gasses
- SPG global fluo in both metric and imperial systems and with fluorescent dial
- Housing in heavy-duty Desmopan material with hose clip
- HP hose
- **Dimensions:** 65 x 25 mm | 2.5 x 1 in
- **Weight:** 395 g | 13.9 oz



FLUO

» Units in Metric and Imperial system

CODE	PRODUCT	CASE PACK
K5853980	MICHELANGELO CONSOLE 3 (GLOBAL FLUO)	4

ACCESSORIES

CODE	PRODUCT
K5851000	BT INTERFACE for DONATELLO/MICHELANGELO
KZ850098	PLASTIC SCREEN PROTECTOR for DONATELLO/MICHELANGELO
KZ811001	PROTECTIVE CASE FOR DIVE CONSOLE

SPARE PARTS

CODE	PRODUCT
KZ770094	BATTERY KIT LEO/GIOTTO/MICHELANGELO/DONATELLO
KZ760525	SCREWS w/ NUT (2 pcs) for LEO/GIOTTO/MICH/DONATELLO BAND
KZ901001	O-RING + CAP for BIG SCREEN COMPUTER



FREEDIVING FUNCTION | DIVE AIR/NITROX PROGRAM

DONATELLO

| DIVE AIR/NITROX PROGRAM | FREEDIVE WRIST COMPUTER

Donatello is an underwater freediving computer. It is ideal for other water activities, thanks to the deactivation option of the "dive" functions, that avoids unnecessary alarms while snorkeling or swimming. It has a high contrast display. The heavy-duty case with a

steel button is fitted with a bezel which, like the protection, is plastic made. The underwater resistance is up to 150 m. The two-tone wrist band is made of TPU rubber with a stainless steel buckle.



Bluetooth
EXTERNAL
BLUETOOTH
DEVICE AVAILABLE



BLACK/BLUE BLACK/SILVER BLACK/YELLOW BLACK/PINK BLACK/RED

CODE	COLOR	CASE PACK
K5860022	Black/Blue	4
K5860051	Black/Silver	4
K5860052	Black/Yellow	4
K5860054	Black/Pink	4
K5860058	Black/Red	4



TECHNICAL FEATURES

- High contrast display with extra large numbers
- Easy access menu 12/24 time format with calendar
- High power backlit display Surf time, desaturation and no fly time calculator
- Battery level indicator
- Units in Metric or Imperial system
- DIVE (AIR/NITROX) PROGRAM**
 - CRESSI RGBM algorithm
 - Complete diving data processor
 - PP02 1.2-1.6 configuration
 - Graphic indicator of CNS toxicity level of oxygen
 - Safety stop indicator
 - Multiple level safety factor configuration
 - Altitude configuration
 - Algorithm for managing uncontrolled ascent Suitable for repeated, multiday decompression diving
 - Visualization of time while diving
 - Deactivable Deep Stop alert
 - Alarm in case of breach of ascent speed, decompression or PP02
 - It is possible to disable the ascent alarms
 - Possibility of eventual total reset, useful for renting purposes
- Planning:** scrolling of no-decompression limits
 - Maximum dive depth alarm
- FREE (APNEA) PROGRAM**
 - Display of all diving parameters
 - Depth
 - Temperature
 - Dive calculator
 - Maximum dive depth alarm
 - Dive time
 - Length of surface interval between each dive
 - Length of diving session
 - Depth, dive time and surface interval alarms
 - Recovery time alarm
 - Visualization of time at dive phase
- GAGE PROGRAM**
 - (Without decompression calculator)
 - Depth/temperature indicator
 - Average depth
 - Dive time in minutes and seconds
 - Resettable depth stopwatch
 - Visualization of time at dive phase
- LOGBOOK up to 50 dives per category**
 - User replaceable battery: cr2430 3v lithium
 - Optional interface with visualization of diving profile



PACKAGING



OPTIONAL ACCESSORIES

| BT INTERFACE Bluetooth

ACCESSORIES

CODE	PRODUCT
K5851000	BT INTERFACE for DONATELLO/MICHELANGELO
K2850098	PLASTIC SCREEN PROTECTOR for DONATELLO/MICHELANGELO
K2700000	ELITE PROTECTIVE CASE for DIVE COMPUTER



SPARE PARTS

CODE	PRODUCT
K2740055	WATCHBAND - BLACK for GIOTTO/DONATELLO/MICHELANGELO
K2760525	SCREWS w/ NUT (2 pcs) for LEO/GIOTTO/MICH/DONATELLO BAND
K2770094	BATTERY KIT LEO/GIOTTO/MICHELANGELO/DONATELLO
K2901001	O-RING + CAP for BIG SCREEN COMPUTER

DONATELLO CONSOLE 2

| DONATELLO + PRESSURE GAUGE

The Donatello Console 2 has been designed to fit the Donatello dive computer in a modern console, robust and easy to handle. It features an easy-to-read Pressure Gauge that features a double scale in metric and imperial systems. The instruments are arranged on a slight tilt, which further improves the design and allows for greater

readability of the same. The use of advanced materials such as polycarbonate and Desmopan has reduced to a minimum thickness and weight, and the console reveals a surprising lightness, which translates into ease of use and minimum strain on the hose connection to the first HP the stadium.



TECHNICAL FEATURES

- Donatello 4 programs dive computer
- SPG global fluo in both metric and imperial systems and with fluorescent dial
- Housing in heavy-duty Desmopan material with hose clip
- HP hose
- **Dimensions:** 65x25 mm | 2.5 x 1 in
- **Weight:** 395 g | 13.9 oz

» Fluorescent is defined as emitting light due to absorbing radiation from an external source, or something vividly colorful. A CFL light bulb that works through radiation is an example of a fluorescent light

FLUO

» Units in Metric and Imperial system



ELITE CASE INCLUDED

CODE	PRODUCT	CASE PACK
KS870000	DONATELLO CONSOLE 2(GLOBAL FLUO)	4

OPTIONAL ACCESSORIES

| BT INTERFACE

ACCESSORIES

CODE	PRODUCT
K5851000	BT INTERFACE for DONATELLO/MICHELANGELO
KZ850098	PLASTIC SCREEN PROTECTOR for DONATELLO/MICHELANGELO
KZ811001	PROTECTIVE CASE FOR DIVE CONSOLE



SPARE PARTS

CODE	PRODUCT
KZ760525	SCREWS w/ NUT (2 pcs) for LEO/GIOTTO/MICH/DONATELLO BAND
KZ770094	BATTERY KIT LEO/GIOTTO/MICHELANGELO/DONATELLO
KZ901001	O-RING + CAP for BIG SCREEN COMPUTER



DONATELLO CONSOLE 3

NEW 2022

COMPUTER + COMPASS

The Donatello Console 3 has been designed to fit the Donatello Cressi dive computer in a modern console, robust and easy to handle. It features an easy-to-read Pressure Gauge, that features a double scale in metric and imperial systems, and a Compass.

The instruments are arranged on a slight tilt, which further improves the design and allows

for greater readability of the same. The use of advanced materials such as polycarbonate and Desmopan has reduced to a minimum thickness and weight, and the console reveals a surprising lightness, which translates into ease of use and minimum strain on the hose connection to the first HP the stadium.

TECHNICAL FEATURES

- Ease of use and minimum strain on the hose connection to the first HP stadium.
- The hose connection has a lower section of the standard (11 mm - 0.43 in), to the advantage of its flexibility and lower weight.
- It is a completely modular, rugged computer with a wide UFD5 display (User-Friendly Display System).
- The algorithm incorporates RGBM and Deep Stop.
- It has complete Nitrox management, depth gauge mode, and a reset option.

FLUO

» Units in Metric and Imperial system



ELITE CASE INCLUDED

CODE	PRODUCT	CASE PACK
KS871000	DONATELLO CONSOLE 3 (GLOBAL FLUO)	4

OPTIONAL ACCESSORIES

| BT INTERFACE

ACCESSORIES

CODE	PRODUCT
K5851000	BT INTERFACE for DONATELLO/MICHELANGELO
KZ850098	PLASTIC SCREEN PROTECTOR for DONATELLO/MICHELANGELO
KZ811001	PROTECTIVE CASE FOR DIVE CONSOLE



SPARE PARTS

CODE	PRODUCT
KZ760525	SCREWS w/ NUT (2 pcs) for LEO/GIOTTO/MICH/DONATELLO BAND
KZ770094	BATTERY KIT LEO/GIOTTO/MICHELANGELO/DONATELLO
KZ901001	O-RING + CAP for BIG SCREEN COMPUTER

ALGORITHM FOR MANAGING TWO DIFFERENT HYPER-OXYGENATED MIXES DURING THE DIVE PHASE
GAS1 21-50% GAS2 21-99%

GIOTTO

| SCUBA DIVING WRIST COMPUTER

The 3-button Giotto computer provides all the necessary information in regards to depth, dive times, possible need of decompression, ascent rate and all the surface intervals between dives. Nitrogen absorption and release is continuously processed by its sophisticated software, taking into account the quantity of inert

gas contained in the different mixtures that can be used.

The computer makes saturation and desaturation calculations of dives carried out both with Air and with Nitrox during any moment of the dive. It allows to set 2 different mixed gasses up to 99% of O2.



BLACK/GRAY

BLACK/BLUE



BLACK/WHITE



CODE	COLOR	CASE PACK
K5740050	Black/Grey	4
K5740052	Black/Blue	4
K5740150	Black/White	4

OPTIONAL ACCESSORIES

| INTERFACE



SEE PAGE 31

ACCESSORIES

CODE	PRODUCT
K5771000	INTERFACE for LEONARDO/GIOTTO
KZ740098	PLASTIC SCREEN PROTECTOR for GIOTTO
KZ700000	ELITE PROTECTIVE CASE for DIVE COMPUTER

SPARE PARTS

CODE	PRODUCT
KZ740050	WATCHBAND - BLACK/GRAY for GIOTTO
KZ740052	WATCHBAND - BLACK/BLUE for GIOTTO
KZ740055	WATCHBAND - BLACK for GIOTTO/MICHELANGELO
KZ740058	WATCHBAND - BLACK/RED for GIOTTO
KZ740150	WATCHBAND - BLACK/WHITE for GIOTTO
KZ760525	SCREWS w/ NUT (2 pcs) for LEO/GIOTTO/MICH/DONATELLO BAND
KZ770094	BATTERY KIT LEO/GIOTTO/MICHELANGELO/DONATELLO
KZ901001	O-RING + CAP for BIG SCREEN COMPUTER

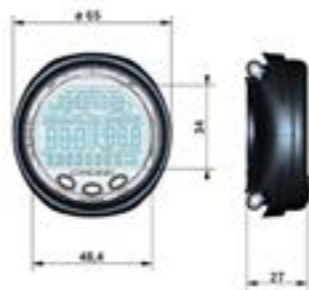

PACKAGING

TECHNICAL FEATURES

- Dual-mixture **CRESSI RGBM** algorithm created through a collaboration between Cressi and Bruce Wienke based on the Haldane model, integrated with RGBM factors for safe decompression calculations in repetitive multi-day dives and with mixtures. Software handles two different hyper-oxygenated mixtures, which can be selected during the dive.
- **Tissues:** 9 saturation half-times ranging from 2.5 to 480 minutes
- **"Dive" Program:** Full processing of dive data, including decompression if applicable.
- For every dive performed with Air or Nitrox
- Full setting of F02 parameters (oxygen percentage) and PO2 (oxygen partial pressure) with the option to set PO2 between 1.2 BAR and 1.6 BAR, and F02 from 21% and 99%
- Option to take a Nitrox dive after one with air (even while desaturating)
- Gage setting option (depth gauge and timer)
- Deactivable Deep Stop alert
- Replaceable screen protector
- **Planning:** decompression curve scrolling
- User can switch units of measure from Metric (meters and C°) to Imperial (feet and F°)
- Graphic CNS oxygen toxicity indicator
- Backlit display
- Log book (70 hr or 60 dives) complete with dive profile
- Option for full reset if needed, helpful when renting the device
- Built-in calendar and clock
- Visual and auditory alarms
- Dive history saved
- Battery level indicator
- User replaceable battery: CR2430 3V Lithium



GIOTTO CONSOLE 2

| GIOTTO + PRESSURE GAUGE

Console Giotto 2 has been designed to fit the dive computer Giotto in a modern console, which differs in form, size and weight of similar products on the market. The different sizes of the two instruments, the Submersible Pressure Gauge and the Computer, have led to a console design truly innovative and original. The instruments are arranged on a slight tilt, which further improves the design and allows for greater readability of the same. The use of advanced materials, such as polycarbonate and Desmopan, have reduced to a minimum thickness and weight and the console reveals a surprising lightness, which obviously translates into ease of use and minimum strain on the hose connection to the first stage HP.



TECHNICAL FEATURES

- Polycarbonate and desmopan materials are lightweight and minimize bulk for reduced drag
- Two connection points, one up top for a clip or bungee and wide loops on the back for connection to any strap, give divers the greatest number of mounting options
- Angled console fits naturally in the hand and positions both the pressure gauge and computer for optimal viewing
- Rugged mini-gauge has a chrome-plated brass case
- Gauge dial is color-coded in red, green and blue for instant readability
- Reads pressures to 350 bar or 5000 psi
- Console measures 65 mm x 25 mm

CODE	PRODUCT	CASE PACK
K5750050	GIOTTO CONSOLE 2 (imperial)	4

ACCESSORIES

CODE	PRODUCT
K5771000	INTERFACE for LEONARDO/GIOTTO
KZ740098	PLASTIC SCREEN PROTECTOR for GIOTTO
KZ700000	ELITE PROTECTIVE CASE for DIVE COMPUTER

SPARE PARTS

CODE	PRODUCT
KZ760525	SCREWS w/ NUT (2 pcs) for LEO/GIOTTO/MICH/DONATELLO BAND
KZ770094	BATTERY KIT LEO/GIOTTO/MICHELANGELO/DONATELLO
KZ901001	O-RING + CAP for BIG SCREEN COMPUTER



ELITE CASE INCLUDED



FREEDIVING FUNCTION | DIVE AIR/NITROX PROGRAM

LEONARDO

| SCUBA DIVING WRIST COMPUTER

An elegant expression of simple, functional design, the Leonardo is a must-have for divers entering the sport and those who "just want to dive". A single button interface makes it effortless to program Air, Nitrox and Gauge modes the first time a diver picks the computer up and an edge-to-edge, high-definition screen gives large numerical

displays in a computer that is still compact and travel-friendly. The highly visible battery life indicator and distinct audible alarms deliver critical information as well as peace-of-mind during the dive. The Leonardo can also be fully reset after each use, making it an excellent choice for rental departments.



CODE	COLOR	CASE PACK
KS770000	Black/Black	4
KS770050	Black/Grey	4
KS770051	Black/Yellow	4
KS770052	Black/Blue	4
KS770054	Black/Pink	4
KS770150	White/Black	4

OPTIONAL ACCESSORIES

| INTERFACE



ACCESSORIES

CODE	PRODUCT
KS771000	INTERFACE for LEONARDO/GIOTTO
KZ770098	PLASTIC SCREEN PROTECTOR for LEONARDO
KZ700000	ELITE PROTECTIVE CASE for DIVE COMPUTER

SPARE PARTS

CODE	PRODUCT
KZ770020	WATCHBAND - BLACK/BLUE for LEONARDO
KZ770040	WATCHBAND - BLACK/PINK for LEONARDO
KZ770050	WATCHBAND - BLACK/GREY for LEONARDO
KZ770051	WATCHBAND - BLACK/YELLOW for LEONARDO
KZ770150	WATCHBAND - BLACK/WHITE for LEONARDO
KZ760525	SCREWS w/ NUT (2 pcs) for LEO/GIOTTO/MICH/DONATELLO BAND
KZ770094	BATTERY KIT LEO/GIOTTO/MICHELANGELO/DONATELLO
KZ901001	O-RING + CAP for BIG SCREEN COMPUTER

TECHNICAL FEATURES

- F02 adjustable between 21% and 50%
- P02 adjustable between 1.2 bar and 1.6 bar
- CNS oxygen toxicity graphic indicator
- Single button interface (short push changes function, longer push selects functions)
- Three levels of user-adjustable conservatism
- Deactivable Deep Stop alert
- Modified Haldane and Wienke algorithm
- Ascent rate alarm (10 m per minute)
- Log book for 60 dives/75 hours of information with 20-second sampling rate
- Distinct, easy-to-hear audible alarms
- User changeable battery
- Units in Metric or Imperial system
- Backlit display
- The instrument may be fully reset, in case of renting
- PC/Mac interface with simulator and dive profile (optional)
- Air, Nitrox and Gauge modes
- Visual and auditory alarms
- Battery life indicator
- **User replaceable battery:** cr2430 3v lithium



MADE IN ITALY

MADE IN ITALY

LEONARDO CONSOLE 2

| COMPUTER + PRESSURE GAUGE

Make gauge checks fast and efficient with this two-gauge console especially crafted for the Leonardo. Polycarbonate materials and smart features make this angled console rugged, lightweight and user-friendly.

The angled console combines the Leonardo with a brass-housed, mini Submersible Pressure Gauge that has a color-coded scale divers can read at a glance.



TECHNICAL FEATURES

- Polycarbonate and desmopan materials are lightweight and minimize bulk for reduced drag.
- Two connection points, one up top for a clip or bungee and wide loops on the back for connection to any strap, give divers the greatest number of mounting options.
- Angled console fits naturally in the hand and positions both the pressure gauge and computer for optimal viewing.
- Rugged mini-gauge has a chrome-plated brass case.
- Console is easy to assemble with each component.
- Gauge dial is color-coded in red, green and blue for instant readability.
- Reads pressures to 350 bar or 5000 psi.
- Console measures 65 mm x 25 mm.
- **Weight with whip and 2 HP tools:** 480 g

CODE	PRODUCT	CASE PACK
KS780050	LEONARDO CONSOLE 2 (Imperial)	4

ACCESSORIES

CODE	PRODUCT
KS771000	INTERFACE for LEONARDO/GIOTTO
KZ770098	PLASTIC SCREEN PROTECTOR for LEONARDO
KZ811001	PROTECTIVE CASE for DIVE CONSOLE

SPARE PARTS

CODE	PRODUCT
KZ760525	SCREWS w/ NUT (2 pcs) for LEO/GIOTTO/MICH/DONATELLO BAND
KZ770094	BATTERY KIT LEO/GIOTTO/MICHELANGELO/DONATELLO
KZ901001	O-RING + CAP for BIG SCREEN COMPUTER



ELITE CASE INCLUDED



PACKAGING



DIVE COMPUTER

| COMPARISON CHART



	CARTESIO	NEON	GOA
Case diameter	1 7/8 in · 48 mm	1 7/8 in · 48 mm	1 7/8 in · 48 mm
Display diameter	1 3/8 in · 35 mm	1 3/8 in · 35 mm	1 3/8 in · 35 mm
Case thickness	5/8 in · 15.8 mm	5/8 in · 15.8 mm	5/8 in · 15.8 mm
Weight	3.2 oz · 92 g	3.2 oz · 92 g	3.1 oz · 87 g
Buttons	2	2	2
Backlit display	Yes	Yes	Yes
Dive programs	Air · Nitrox · Gage · Free	Air · Nitrox · Gage · Free	Air · Nitrox · Gage · Free
Dive planner	Yes	Yes	Yes
Max dive time	1,032 min	1,032 min	1,032 min
Max depth	393 ft 120 m	393 ft 120 m	393 ft 120 m
Average depth	Yes	Yes	Yes
Depth sampling rate	1 second	1 second	1 second
Thermometer	Resolution: 1°F / 1°C Measuring field: 23°F - 104°F (-5°C - +40°C) Precision: 3.6°F (2°C) / 10 min change temp	Resolution: 1°F / 1°C Measuring field: 23°F - 104°F (-5°C - +40°C) Precision: 3.6°F (2°C) / 10 min change temp	Resolution: 1°F / 1°C Measuring field: 23°F - 104°F (-5°C - +40°C) Precision: 3.6°F (2°C) / 10 min change temp
Algorithm	Dual-mixture Cressi-Wienke RGBM with Uncontrolled Ascent Protection Algorithm	Dual-mixture Cressi-Wienke RGBM with Uncontrolled Ascent Protection Algorithm	Air/Nitrox Cressi-Wienke RGBM with Uncontrolled Ascent Protection Algorithm
Visual and Auditory alarms	Yes	Yes	Yes
Ascent alarm	On / Off	On / Off	On / Off
Deep stop	On / Off	On / Off	On / Off
Tissue saturation	9 saturation half-times ranging from 2.5 to 480 minutes	9 saturation half-times ranging from 2.5 to 480 minutes	9 saturation half-times ranging from 2.5 to 480 minutes
CNS oxygen toxicity indicator/alarm	Yes	Yes	Yes
PO2 parameters	1.2 BAR - 1.6 BAR	1.2 BAR - 1.6 BAR	1.2 BAR - 1.6 BAR
FO2 parameters	Mix1: 21% to 50% Mix2: 21% to 99%*	*Mix1: 21% to 50% Mix2: 21% to 99%*	21% to 50%
Stopwatch during Gage mode	Yes, Resettable	Yes, Resettable	Yes, Resettable
Clock (during the dive)	Yes	Yes	Yes
No-fly time	Yes with countdown	Yes with countdown	Yes with countdown
Altitude diving	Yes until 12,140 ft 3,700m	Yes until 12,140 ft 3,700m	Yes until 12,140 ft 3,700m
Log Book	60 h / 50 dives	60 h / 50 dives	60 h / 50 dives
PC / MAC connection	USB interface Bluetooth/USB Interface	USB interface Bluetooth/USB Interface	USB interface Bluetooth/USB Interface
Data acquisition frequency	5 second (Air/Nitrox/Gage), 2 second (Free)	5 second (Air/Nitrox/Gage), 2 second (Free)	5 second (Air/Nitrox/Gage), 2 second (Free)
Temperature logbook acquisition	Yes	Yes	Yes
Full data reset	Yes	Yes	Yes
Calendar	Yes	Yes	Yes
Alarm clock	Yes	Yes	Yes
Secondary time	Yes	Yes	Yes
Chronograph	Yes	Yes	Yes
Battery type	CR 2450 3V	CR 2450 3V	CR 2450 3V
Estimate battery life (50 dives / year)	4 years	4 years	4 years
User replaceable battery	Yes	Yes	Yes
User replaceable watchband	Yes	Yes	Yes
Watchband extension	Yes	Yes	Yes
Unit system	Metric · Imperial	Metric · Imperial	Metric · Imperial
Interface	K5822001	K5822001	K5822001



	KING	NEPTO
Case diameter	1 7/8 in · 48 mm	1 7/8 in · 48 mm
Display diameter	1 3/8 in · 35 mm	1 3/8 in · 35 mm
Case thickness	5/8 in · 15.8 mm	5/8 in · 15.8 mm
Weight	3.2 oz · 92 g	3.1 oz · 87 g
Buttons	2	2
Backlit display	Yes	Yes
Dive programs	Free · Lock · Sleep	Free · Lock · Sleep
Max dive time	-	-
Max depth	393 ft · 120 m	393 ft · 120 m
Average depth	-	-
Depth sampling rate	0,5 second	0,5 second
Algorithm	Taravana protection algorithm Edema protection algorithm	Taravana protection algorithm Edema protection algorithm
Thermometer	Resolution: 1°F / 1°C Measuring field: 23°F + 104°F (-5°C + 40°C) Precision: 3.6°F (2°C) / 10 min change temp	Resolution: 1°F / 1°C Measuring field: 23°F + 104°F (-5°C + 40°C) Precision: 3.6°F (2°C) / 10 min change temp
Visual and Auditory alarms	Yes	Yes
Alarms	Surf, Depth, Dive, Step time (available during the dive) Hydratation	Surf, Depth, Dive, Step time (available during the dive) Hydratation
Water salinity	Fresh/Salt	Fresh/Salt
Tide level indicator	Yes	Yes
No-fly time	Yes	Yes
Altitude diving	-	-
Log book	up to 90 dives (available during the dive)	up to 90 dives (available during the dive)
Sample rate	off · 0.5 s · 1 s · 2 s ·	off · 0.5 s · 1 s · 2 s ·
Calendar	Yes	Yes
Alarm clock	Yes	Yes
Secondary time	Yes	Yes
Stopwatch + Dualtimer	Yes	Yes
Battery type	CR 2450 3V	CR 2450 3V
Estimate battery life	4 years	4 years
User replaceable battery	Yes	Yes
Sleep mode (battery safe)	Yes	Yes
User replaceable watchband	Yes	Yes
Watchband extension	Yes	Yes
Unit system	Metric · Imperial	Metric · Imperial
Interface	K5822001	K5822001

DIVE COMPUTER

| COMPARISON CHART



	MICHELANGELO	GIOTTO	DONATELLO	LEONARDO
Case diameter	2 5/8 in · 67 mm	2 5/8 in · 67 mm	2 5/8 in · 67 mm	2 5/8 in · 67 mm
Display diameter	1 7/8 in · 47 mm	1 7/8 in · 47 mm	1 7/8 in · 47 mm	1 7/8 in · 47 mm
Case thickness	1 1/16 in · 27 mm	1 1/16 in · 27 mm	1 1/16 in · 27 mm	1 1/16 in · 27 mm
Weight	4.9 oz · 140 g	4.8 oz · 135 g	4.8 oz · 135 g	4.8 oz · 135 g
Buttons	1	3	1	1
Backlit display	Yes	Yes	Yes	Yes
Dive programs	Air · Nitrox · Gage · Free	Air · Nitrox · Gage	Air · Nitrox · Gage · Free	Air · Nitrox · Gage
Dive planner	Yes	Yes	Yes	Yes
Max dive time	1,032 min	255 min	1,032 min	255 min
Max depth	393 ft 120 m	393 ft 120 m	393 ft 120 m	393 ft 120 m
Average depth	Yes	No	Yes	No
Depth sampling rate	1 second	1 second	1 second	1 second
Thermometer	Resolution: 1°F / 1°C Measuring field: -5°C / +40°C · 23°F / 104°F Precision: 3.6°F (2°C) / 10 min change temp	Resolution: 1°F / 1°C Measuring field: -5°C / +40°C · 23°F / 104°F Precision: 3.6°F (2°C) / 10 min change temp	Resolution: 1°F / 1°C Measuring field: -5°C / +40°C · 23°F / 104°F Precision: 3.6°F (2°C) / 10 min change temp	Resolution: 1°F / 1°C Measuring field: -5°C / +40°C · 23°F / 104°F Precision: 3.6°F (2°C) / 10 min change temp
Algorithm	Dual-mixture Cressi-Wienke RGBM with Uncontrolled Ascent Protection Algorithm	Air Nitrox Cressi-Wienke RGBM	Dual-mixture Cressi-Wienke RGBM with Uncontrolled Ascent Protection Algorithm	Air Nitrox Cressi-Wienke RGBM
Visual and Auditory alarms	Yes	Yes	Yes	Yes
Ascent alarm	On / Off	Permanent	On / Off	Permanent
Deep stop	On / Off	On / Off	On / Off	On / Off
Tissue saturation	9 saturation half-times ranging from 2.5 to 480 minutes	9 saturation half-times ranging from 2.5 to 480 minutes	9 saturation half-times ranging from 2.5 to 480 minutes	9 saturation half-times ranging from 2.5 to 480 minutes
CNS oxygen toxicity indicator/alarm	Yes	Yes	Yes	Yes
PO2 parameters	1.2 BAR - 1.6 BAR	1.2 BAR - 1.6 BAR	1.2 BAR - 1.6 BAR	1.2 BAR - 1.6 BAR
FO2 parameters	Mix1: 21% to 50% Mix2: 21% to 99%*	Mix1: 21% to 50% Mix2: 21% to 99%*	21% to 50%	21% to 50%
Stopwatch during Gage mode	Yes, Resettable	Yes	Yes, Resettable	No
Clock (during the dive)	Yes	No	Yes	No
No-fly time	Yes with countdown	Yes	Yes with countdown	Yes
Altitude diving	3-levels, until 3700 m · 12,140 ft	3-levels, until 3700 m · 12,140 ft	3-levels, until 3700 m · 12,140 ft	3-levels, until 3700 m · 12,140 ft
Log Book	60 h / 50 dives	70 h / 60 dives	60 h / 50 dives	70 h / 60 dives
Data acquisition frequency	5 second (Air/Nitrox/Gage), 2 second (Free)	20 seconds	5 second (Air/Nitrox/Gage), 2 second (Free)	20 seconds
Temperature logbook acquisition	Yes	No	Yes	No
Full data reset	Yes	Yes	Yes	Yes
Calendar	Yes	Yes	Yes	Yes
Alarm clock	Yes	Yes	Yes	Yes
Secondary time	Yes	No	Yes	No
Chronograph	Yes	No	Yes	No
Battery type	CR 2430 3V	CR 2430 3V	CR 2430 3V	CR 2430 3V
Estimate battery life (50 dives / year)	3 years	3 years	3 years	2 years
User replaceable battery	Yes	Yes	Yes	Yes
User replaceable watchband	Yes	Yes	Yes	Yes
Watchband extension	Yes	No	Yes	No
Unit system	Metric Imperial	Metric Imperial	Metric Imperial	Metric Imperial
Interface	K5851000	K5771000	K5851000	K5771000

BT INTERFACES

| BLUETOOTH / USB



USB CABLE INCLUDED

INTERFACE SOFTWARE

External docking station to send data to your smartphone – compatible with Android (from OS version 7.0 onwards) and iOS (from OS version 10 onwards) – or to transfer data on PC (from Windows 7 onwards) and Mac (from Yosemite onwards) through USB connection.

The docking station is equipped with a CR 2032 battery included and replaceable by the user, which allows not to consume the internal battery of the dive computer. The specific App is available on the Google Play Store and Apple App Store.

DIVE-WATCH COMPUTER



GOA - NEON - CARTESIO - NEPTO
KS822001

BIG-DISPLAY COMPUTER



DONATELLO - MICHELANGELO
KS851000

CODE	PRODUCT	CASE PACK
KS822001	BT INTERFACE for DIVE-WATCH COMPUTER	10
KS851000	BT INTERFACE for DONATELLO/MICHELANGELO	10

Download Cressi app and explore your dives on your smartphone



INTERFACE COMPATIBILITY

Android OS	From OS version 9.0 onwards
Apple iOS	From OS version 12 onwards
Windows OS	From Windows 10 onwards
Mac OS	From Sierra onwards
Connection	USB cable for personal computer Bluetooth for Cressi smartphone App

Big-display computers



MICHELANGELO DONATELLO

Dive-watch computer



CARTESIO NEON
GOA NEPTO
KING



PACKAGING



USB INTERFACE

| LEONARDO - GIOTTO

Divers have the opportunity to fully manage the data and functions of their Leonardo or Giotto computer with this Cressi Interface. It's easy to connect both wrist and console mounted units, which simply sit on top of the USB-powered docking station. With the Interface, the user can download the dive records and view all the data of the dive sessions including time, depth, and distance.



» Interface Software and User manual available in the Download area of cressi.com



CODE	PRODUCT	CASE PACK
KS771000	INTERFACE for LEONARDO/GIOTTO	10

TECHNICAL FEATURES

- Interface works with both wrist and console units
- Connects through any USB port.
- Upload dive data and manage computer functions
- Green indicator light confirms when positive connection established.
- PC interface software compatible with both Windows and Mac operating systems.

INTERFACE COMPATIBILITY

Windows OS	From Windows XP onwards
Mac OS	From 10.8 to 10.15 (Catalina). Not available for Big Sur or more recent operating systems.
Connection	USB CABLE

Computer watches



LEONARDO GIOTTO



GET IT ON
 CRESSI.COM



USB CABLE INCLUDED



37 YEARS
MANUFACTURE
QUALITY SINCE
1946



AUTOMATIC ACTIVATION WITH CONNECTION TO THE TANK | PRESSURE GAUGE

DIGI NEW 2022

DIGITAL PRESSURE GAUGE

This very precise console is easy to use even in the most difficult conditions.

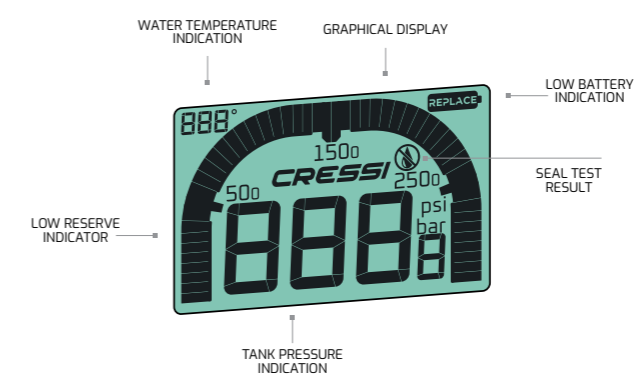

CODE	PRODUCT	STYLE	CASE PACK
KC790010	Yellow	BAR	35
KC790110	Yellow	PSI	35

ALSO FOR RENTAL | MADE IN ITALY

CRESSI

SCUBA / DIGITAL GAUGES

TECHNICAL FEATURES

- Automatic activation with connection to the tank
- High contrast display
- Tank pressure indicator 0-300 BAR - 0-4.351 PSI
- Graphical display
- Water temperature indicator -10°C / +50°C · 14°F / 122°F
- Gas reserve below 50 BAR indicator
- Autonomy up to 1000 hours in immersion
- Low battery indicator
- Self-diagnosis for battery change (patented)
- User-replaceable silicone protective shell
- **Dimensions:** 9.9 x 5.2 x 2.8 cm · 3.89 x 2.04 x 1.10 in
- **Weight:** 122 g · 4.30 oz

SELF-DIAGNOSIS FOR BATTERY CHANGE (PATENTED)



RESIDUAL GAS AUTONOMY INDICATOR (IN MINUTES) | AUTOMATIC ACTIVATION WITH CONNECTION TO THE TANK | PRESSURE GAUGE + DEPTH GAUGE

SPECIALIZED Retailer Product | ALSO FOR RENTAL | MADE IN ITALY

DIGI2

| DIGITAL CONSOLE

Designed for the harshest conditions, this extremely precise console is also easy to use. DIGI 2 Smart cover makes your digital console enter in SLEEP MODE, which helps to extend the battery life.

DOUBLE SCALE
METRIC AND IMPERIAL



TECHNICAL FEATURES

- Automatic activation when connected to the tank
- High contrast display
- Depth indicator 0-120 m | 0-393 ft
- Tank pressure indicator 0-300 BAR · 0-4,351 PSI
- Water temperature indicator -10°C/+50°C · 14°F/122°F
- Residual gas autonomy in minutes indicator
- Gas reserve below 50 BAR · 725 PSI indicator
- Maximum depth of the last dive
- Autonomy up to 1000 hours in immersion
- Low battery indicator
- Self-diagnosis for battery change (patented)
- Dedicated smartbox that allows you to interact (patented)
- User-replaceable silicone protective shell
- **Dimensions:** 9.9 x 5.2 x 2.8 cm · 3.9x2x1.1 in
- **Weight:** 122 g · 4.3 oz
- Self-diagnosis for battery change (patented)
- protective smart cover included



PROTECTIVE SMART COVER INCLUDED



CODE	COLOR	CASE PACK
JK800058	Red	35
KC800020	Blue	35
KC800030	White	35
KC800040	Pink	35
KC800050	Grey	35
KC800055	Black	35



PACKAGING



Photo by: Lluís Masuet

SELF-DIAGNOSIS FOR BATTERY CHANGE (PATENTED)

PROTECTIVE SMART COVER INCLUDED



SPARE PARTS

CODE	PRODUCT
KZ790001	SMART COVER for DIGI2
KZ790002	REVOLVING RING DOUBLE for DIGI2
KZ790003	BATTERY KIT for DIGI2 (CR2450 3V)
KZ790020	DIGI2 COVER - BLUE
KZ790030	DIGI2 COVER - WHITE
KZ790040	DIGI2 COVER - PINK
KZ790050	DIGI2 COVER - GREY
KZ790055	DIGI2 COVER - BLACK
KZ790058	DIGI2 COVER - RED

CONSOLE CPD3

| COMPASS + PRESSURE GAUGE + DEPTH GAUGE

Two connection loops, one on each side, for attaching a clip or bungee.



TECHNICAL FEATURES

- Compass with rotating bezel for easy navigation
- Pressure gauge dial is color-coded in red, green and blue for instant readability
- Reads pressures to 350 BAR or 5000 PSI
- Mini-depth gauge reads to 70 meters - 230 feet
- Maximum depth indicator
- Compact rubber boot is textured for a sure grip
- **Total weight:** 420 g - 14.8 oz

350 BAR - 5000 PSI PRESSURE READINGS | ROTATING BEZEL COMPASS | 70 M DEPTH GAUGE

CODE	PRODUCT	STYLE	CASE PACK
KC764455	CONSOLE CPD3 (IMPERIAL)	Imperial	4
NEW KC764480	CONSOLE CPD3 (GLOBAL FLUO)	Global Fluo	4

CP2

| COMPASS + PRESSURE GAUGE

Compact and built to last, this console combines a Mini SPG and a compass. The textured boot is easy to handle, even while wearing gloves, and can be rigged with a clip or bungee and secured to the diver's BC for a streamlined profile in the water.



TECHNICAL FEATURES

- Compass with rotating bezel for easy navigation
- Pressure gauge dial is color-coded in red, green and blue for instant readability
- Reads pressures to 350 BAR or 5000 PSI
- Both instruments built with chrome-plated brass case for maximum durability
- Compact rubber boot is textured for a sure grip
- Two connection loops, one on each side, for attaching a clip or bungee
- **Weight of console:** 420 g - 14.8 oz

350 BAR - 5000 PSI PRESSURE READINGS | ROTATING BEZEL COMPASS

CODE	PRODUCT	STYLE	CASE PACK
NEW KC764380	CONSOLE CP2 (GLOBAL FLUO)	Global Fluo	4
KC765350	CONSOLE CP2 (IMPERIAL)	Imperial	4

PD2

| PRESSURE GAUGE + DEPTH GAUGE

Compact and built to last, this two-gauge console combines a Mini SPG and depth gauge. The textured boot is easy to handle, even while wearing gloves, and can be rigged with a clip or bungee and secured to the diver's BC for a streamlined profile in the water.



TECHNICAL FEATURES

- Compass with rotating bezel for easy navigation
- Pressure gauge dial is color-coded in red, green and blue for instant readability
- Reads pressures to 350 BAR or 5000 PSI
- Both instruments built with chrome-plated brass case for maximum durability
- Compact rubber boot is textured for a sure grip
- Two connection loops, one on each side, for attaching a clip or bungee
- **Weight of console:** 420 g - 14.8 oz

350 BAR - 5000 PSI PRESSURE READINGS | 70 M - 230 FT DEPTH GAUGE

CODE	PRODUCT	STYLE	CASE PACK
KC764650	CONSOLE PD2 (IMPERIAL)	Imperial	4
NEW KC764680	CONSOLE PD2 (GLOBAL FLUO)	Global Fluo	4

SPARE PARTS

CODE	PRODUCT
K5764109	COMPASS MODULE ONLY
KZ760601	DEPTH GAUGE MODULE (GLOBAL FLUO)
KZ764961	PRESSURE GAUGE MODULE (GLOBAL FLUO) [w/ HOSE w/o BOOT]
KZ760505	DEPTH GAUGE MODULE (IMPERIAL)
KZ801010	PRESSURE GAUGE MODULE (PSI) [w/ HOSE w/o BOOT]



MINICONSOLE 2

| IMPERIAL

| GLOBAL FLUO



Compact and built to last, this two-gauge console combines a Mini SPG and depth gauge. The textured boot is easy to handle, even while wearing gloves, and can be rigged with a clip or bungee and secured to the diver's BC for a streamlined profile in the water.

CODE	PRODUCT	STYLE	CASE PACK
KC765250	MINICONSOLE 2 (IMPERIAL)	Imperial	4
KC766255	MINICONSOLE 2 (GLOBAL FLUO)	Global Fluo	4

SPARE PARTS

CODE	PRODUCT
KZ760601	DEPTH GAUGE MODULE (GLOBAL FLUO)
KZ764961	PRESSURE GAUGE MODULE (GLOBAL FLUO) [w/ HOSE w/o BOOT]
KZ760505	DEPTH GAUGE MODULE (IMPERIAL)
KZ801010	PRESSURE GAUGE MODULE (PSI) [w/ HOSE w/o BOOT]

TECHNICAL FEATURES

- Pressure gauge dial is color-coded in red, green and blue for instant readability.
- Reads pressures to 350 BAR or 5000 PSI.
- Mini-depth gauge reads to 70 meters - 230 feet
- Maximum depth indicator.
- Luminescent face on the depth gauge.
- Depth indications spaced out in first 12 meters - 40 feet for precise readings during safety stops.
- Both instruments built with chrome-plated brass case for maximum durability.
- Compact rubber boot is textured for a sure grip.
- Two connection loops, one on each side, for attaching a clip or bungee.
- **Weight of console:** 420 g - 14.8 oz (includes hose).

350 BAR - 5000 PSI PRESSURE READINGS

MINI SPG

| PRESSURE GAUGE

| GLOBAL FLUO



Fluorescent is defined as emitting light due to absorbing radiation from an external source, or something vividly colorful. A CFL light bulb that works through radiation is an example of a fluorescent light

CODE	PRODUCT	STYLE	CASE PACK
KK760400	MINI SPG w/ RUBBER HOUSING (PSI)	Imperial	4
KK760510	MINI SPG w/ RUBBER HOUSING (GLOBAL FLUO)	Global Fluo	4

SPARE PARTS

CODE	PRODUCT
KZ764961	PRESSURE GAUGE MODULE (GLOBAL FLUO) [w/ HOSE w/o BOOT]
KZ801010	PRESSURE GAUGE MODULE (PSI) [w/ HOSE w/o BOOT]

TECHNICAL FEATURES

- Gauge dial is color-coded in red, green and blue for instant readability.
- Reads pressures to 350 BAR or 5000 PSI.
- Rugged mini-gauge has a chrome-plated brass case.
- Compact rubber boot is textured for a sure grip.
- Connection loop up-top is perfect for attaching a clip or bungee.

NORTHERN AND SOUTHERN HEMISPHERES COMPATIBILITY | ROTATING BEZEL COMPASS

COMPASS



WITH STRAP AND HOSE MOUNT

MODULE

TECHNICAL FEATURES

- Top and side reading
- Luminescent gauge face
- Highly accurate
- With strap and bcd holder

CODE	PRODUCT	CASE PACK
KB760100	COMPASS w/ STRAP AND HOSE MOUNT	10
K5764109	COMPASS MODULE ONLY	5

SPARE PARTS CATALOGUE AVAILABLE

MAGNIFYING EFFECT +15% LARGER DISPLAY NUMBERS

SPARE PARTS CATALOGUE AVAILABLE

ADDITIONAL LENGTH +4 INCH / 10 CM

PLASTIC SCREEN PROTECTOR



CODE	PRODUCT
KZ740098	GIOTTO
KZ770098	LEONARDO
KZ850098	DONATELLO/MICHELANGELO

DESCRIPTION:
The screen protector eliminates almost completely the effects of abrasion and shocks while making for perfect visibility.

ELITE PROTECTIVE CASE



CODE	PRODUCT
KZ700000	ELITE PROTECTIVE CASE for DIVE COMPUTER
UB940050	GENIUS DIVE CONSOLE BAG

BIG-SCREEN DIVE COMPUTER WATCHBAND



CODE	PRODUCT
KZ740050	WATCHBAND - BLACK/GREY for GIOTTO
KZ740052	WATCHBAND - BLACK/BLUE for GIOTTO
KZ740055	WATCHBAND - BLACK for GIOTTO/DONATELLO/MICHELANGELO
KZ740058	WATCHBAND - BLACK/RED for GIOTTO
KZ740150	WATCHBAND - BLACK/WHITE for GIOTTO
KZ770020	WATCHBAND - BLACK/BLUE for LEONARDO
KZ770040	WATCHBAND - BLACK/PINK for LEONARDO
KZ770050	WATCHBAND - BLACK/GREY for LEONARDO
KZ770051	WATCHBAND - BLACK/YELLOW for LEONARDO
KZ770150	WATCHBAND - BLACK/WHITE for LEONARDO
KZ850097	WATCHBAND - BLACK for DONATELLO/MICHELANGELO

COMPUTER BATTERY KIT



CODE	PRODUCT
KZ770094	BATTERY KIT for BIG SCREEN COMPUTER
KZ901001	O-RING + CAP for BIG SCREEN COMPUTER

DESCRIPTION:
Replacement spare part kits for big screen dive computers

WATCHBAND / CONSOLE SCREWS



CODE	PRODUCT
KZ760525	SCREWS w/ NUT (2 pcs) for BIG-DISPLAY DIVE COMPUTER

DESCRIPTION:
Stainless steel screw + nut for big screen dive computers

COMPATIBILITY:
• Giotto computer
• Leonardo computer
• Donatello computer
• Michelangelo computer
• Console computer

SILICONE SCREEN PROTECTOR



CODE	PRODUCT
K5890000	SILICONE SCREEN PROTECTOR for DIVE WATCH

DESCRIPTION:
The screen protector eliminates almost completely the effects of abrasion and shocks on both the display and the sides of the bezel, while making for perfect visibility. Thanks to this protection, the dive computer retains its pleasing, undamaged appearance even after prolonged, intensive underwater use.

COMPATIBILITY:
Cartesio, Neon, Goa, Nepto, King

WATCHBAND EXTENDER



CODE	PRODUCT
KZ810000	STRAP EXTENDER for DIVE-WATCH COMPUTER - BLACK/BLACK

DESCRIPTION:
Designed to wear the dive watch computer over a thick wetsuit. Made with the same high-quality rubber and corrosion-resistant materials as the original straps. Easily clasps on the buckle end of the computer's strap increasing its length.

COMPATIBILITY:
Cartesio, Neon, Goa, Nepto, King

COMPUTER BATTERY KIT



CODE	PRODUCT
KZ820094	BATTERY KIT (CR2450 + O-RING) for WATCH-STYLE COMPUTER
KZ901000	O-RING + SCREWS for WATCH-STYLE COMPUTER

DESCRIPTION:
Replacement spare part kits for computer watches

COMPATIBILITY:
Cartesio, Neon, Goa, Nepto, King

WATCHBAND SCREWS



CODE	PRODUCT
KZ805099	SCREWS w/ NUT (1 pair) for WATCH-STYLE DIVE COMPUTER WATCHBAND

DESCRIPTION:
Stainless steel screws for watch-style dive computer watchbands. Sold by pair.

COMPATIBILITY:
Cartesio, Neon, Goa, Nepto, King

WATCH-STYLE DIVE COMPUTER WATCHBAND

CODE	PRODUCT
KZ820050	WATCHBAND - BLACK/GREY for GOA
KZ820052	WATCHBAND - BLACK/BLUE for GOA
KZ820053	WATCHBAND - BLACK/WHITE for GOA/KING
KZ820140	WATCHBAND - WHITE/PINK for GOA
KZ820150	WATCHBAND - WHITE/BLACK for GOA
KZ8230050	WATCHBAND - BLACK for CARTESIO
KZ840020	WATCHBAND - BLACK/BLUE for NEON/NEPTO
KZ840050	WATCHBAND - BLACK/GREY for NEON
KZ840055	WATCHBAND - BLACK/BLACK for NEON/NEPTO
KZ840058	WATCHBAND - BLACK/RED for NEON
KZ840067	WATCHBAND - BLACK/LIME for NEON
KZ840085	WATCHBAND - BLACK/ORANGE for NEON
KZ840141	WATCHBAND - WHITE/LILAC for NEON
KZ841098	WATCHBAND - BLACK/GREEN for NEPTO
KZ842020	SILICONE WATCHBAND - BLUE for KING
KZ842050	SILICONE WATCHBAND - BLACK for KING
KZ842085	SILICONE WATCHBAND - ORANGE for KING

WATCH SPARE PARTS	
CODE	PRODUCT
KZ764700	WATCHSTRAP - BLACK for MANTA
KZ764755	WATCHSTRAP - BLACK/BLACK for MANTA
KZ764788	WATCHSTRAP - RED for MANTA
KZ764820	WATCHSTRAP - BLUE for NEREUS
KZ764855	WATCHSTRAP - BLACK/BLACK for NEREUS
XKZ000001	MANTA BATTERY KIT w/O-RING (RENATA 371 - 36.0 x Ø 0.8 mm)
XKZ000003	NEREUS BATTERY KIT w/O-RING (SONY SR621SW - 37.5 x Ø 1.0 mm)

NEW
NEW
NEW



CONSOLE SPARE PARTS

DIGI2 SMART COVER



CODE
KZ790001

DESCRIPTION:
Smart display cover for DIGI2 console.

SUITABLE FOR:
DIGI2 Console

DIGI2 COVERS



CODE	PRODUCT
KZ790020	DIGI2 COVER - BLUE
KZ790030	DIGI2 COVER - WHITE
KZ790040	DIGI2 COVER - PINK
KZ790050	DIGI2 COVER - GREY
KZ790055	DIGI2 COVER - BLACK
KZ790058	DIGI2 COVER - RED

BATTERY KIT



CODE
KZ790003

DESCRIPTION:
Replacement battery CR2450 + O-Ring and rear cap kit.

SUITABLE FOR:
DIGI2 Console
DIGI Console

PRESSURE GAUGE MODULE W/ HOSE



CODE **STYLE**

KZ764961 GLOBAL FLUO

KZ801010 GLOBAL FLUO

DESCRIPTION:
Mini SPG + hose without rubber boot.

PRESSURE GAUGE MODULE W/O HOSE



CODE **STYLE**

KZ760600 GLOBAL FLUO

KZ760400 IMPERIAL

DESCRIPTION:
Mini SPG module without boot and hose.

DEPTH GAUGE MODULE



CODE **PRODUCT**

KZ760601 GLOBAL FLUO

KZ760505 IMPERIAL

DESCRIPTION:
Mini-depth gauge module for console.

SUITABLE FOR:
PD2 Console
CPD3 Console
Computer Console 2

COMPASS MODULE



CODE
K5764109

DESCRIPTION:
Spare compass module for console.

SUITABLE FOR:
CP2 Console
CPD3 Console
Computer Console 3

HP HOSE SWIVEL WITH O-RINGS



CODE

KZ760501

KZ760503

DESCRIPTION:
HP hose for pressure gauge. length: 81 cm / 32 inch.

Swivel replacement with o-ring for High Pressure hoses.

BOOT FOR CPD3

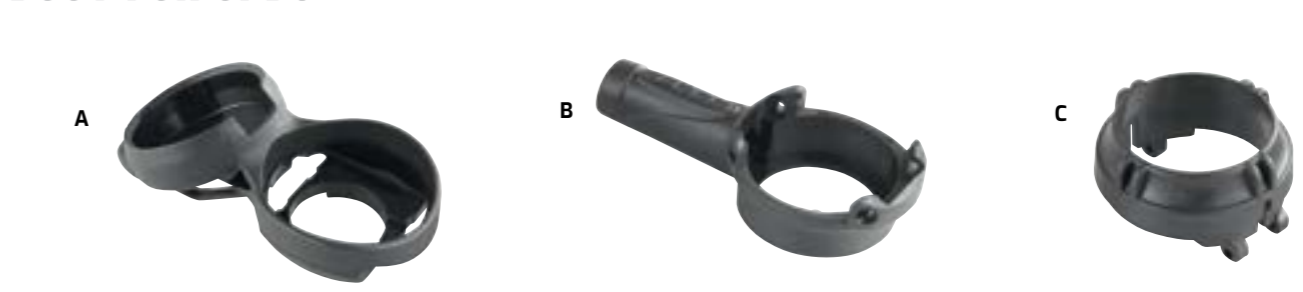

CODE	PRODUCT
KZ764920	PART A
KZ770190	PART B
KZ764930	PART C
KZ764921	COMPLETE

BOOT FOR PD2



CODE	PRODUCT
KZ764900	PART A
KZ764910	PART B
KZ764911	COMPLETE

BOOT FOR CP2



CODE	PRODUCT
KZ764900	PART A
KZ764910	PART B
KZ764916	COMPLETE



MINICONSOLE 2

CODE
KZ764096



MINI SPG

CODE
KZ760519



 **SCUBA**

REGULATORS

82VE
MANUFACTURE
QUALITY SINCE
1946

HIGH PERFORMANCE
REGULATOR CERTIFIED
EN 250/2014 FOR COLD WATERS

STAINLESS STEEL
2ND STAGE COVER

CERTIFIED
EN 250/2014
FOR COLD WATERS



1ST STAGE T10-SC CROMO

2ND STAGE GALAXY-R

TOTAL WEIGHT

T10-SC/GALAXY-R INT HOSE INCLUDED: 1.055 g | 2 lb 5 oz

T10-SC/GALAXY-R DIN HOSE INCLUDED: 937 g | 2 lb 1 oz



TECHNICAL FEATURES 1ST STAGE

- Hyperbalanced diaphragm
- 2 HP 7/16 UNF ports
- 4 MP 3/8 UNF ports
- **Operating pressure:**
INT version: 230 BAR | 3,336 PSI
DIN Version: 300 BAR | 4,351 PSI
- **Calibration pressure:** 10 BAR | 146 PSI
- High-capacity conical filter in chemically nickel-plated spherical bronze
- Removable nozzle in AISI 316 steel
- Hyperbalancing system
- Anti-pressure drop pneumatic spring
- Stainless steel calibration spring with micropeening treatment
- Low-friction technopolymer slider shaft
- **Quantity of air supplied:** 4500 l/min | 159 cu ft/min

TECHNICAL FEATURES 1ST STAGE

- Pneumatically balanced
- Adjustable Venturi
- Adjustable inhalation effort
- Patented elliptical diaphragm
- Patented low-friction lever
- Air delivery system without injector
- Adjuster knob coated with dual OR
- Internal heat exchanger
- Cap opening with Cam-lock
- Noise-absorbing technopolymer body
- Removable technopolymer deflector
- Removable mechanics
- **COMBINATION PERFORMANCE**
- Average Cracking effort 3.5 mBAR | 1.41 inwc
- Average breathing effort 0.6 J/l
- **JACKETED HOSE**
- Extremely light and flexible
- **weight:** 153 g | 5.4 oz
- **CERTIFICATION**
- EN250/2014 for cold water

Very high-performance regulator, engineered in Italy with the best technology available. Ideal for seasoned or professional divers who need extremely high performing equipment that is both simple and resistant, without any of

the usual accessories that may get damaged. The T10-SC features a watertight chamber designed for cold water use. Chrome finishing. The Galaxy-R features the adjustable inhalation effort knob on the left side.

CODE	PRODUCT	STYLE	CASE PACK
HX890000	T10-SC CROMO/GALAXY ADJ (INT)	INT	1
HX890100	T10-SC CROMO/GALAXY ADJ (DIN)	DIN	1

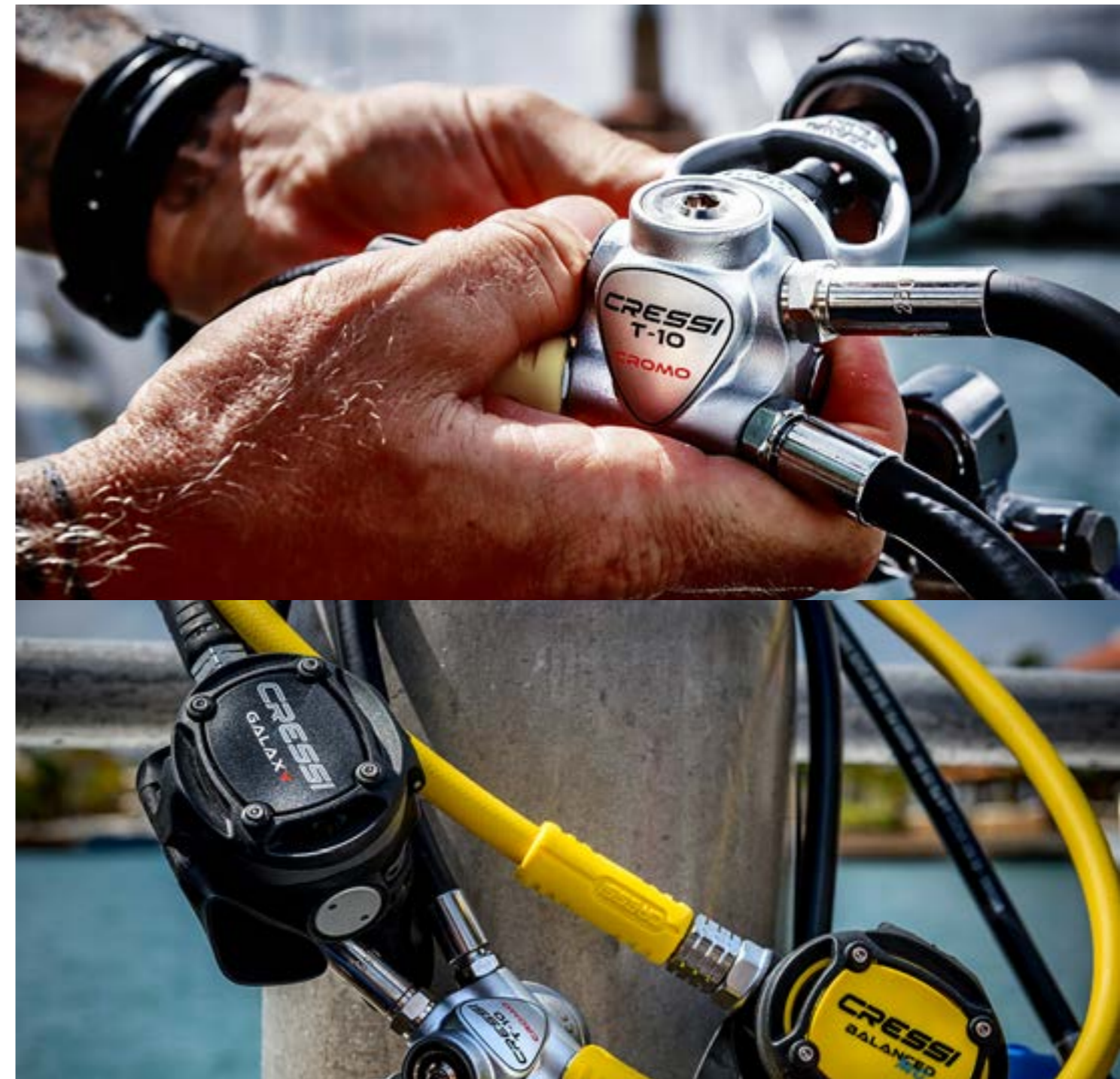

SPARE PARTS

CODE	PRODUCT
HZ800045	MAINTENANCE KIT for T10/T10-SC INT/DIN
HZ820080	MAINTENANCE KIT for MASTER/GALAXY/ELLIPSE BALANCED
HZ830035	DIN ASSEMBLY for T10/T10-SC



ELITE CASE INCLUDED



Certification EN250/2014 for cold water
The T10-SEAL CHAMBER 1ST stage is environmentally sealed, protecting it against icing in cold water and against contamination from particulate matter in silty conditions.

RESULTS: INHALE PRESSURE, EXHALE PRESSURE AND EXT WORK OF BREATHING

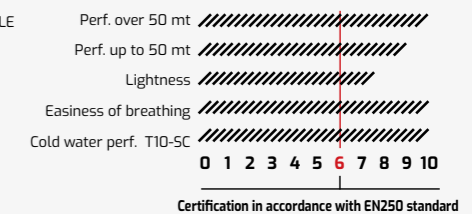
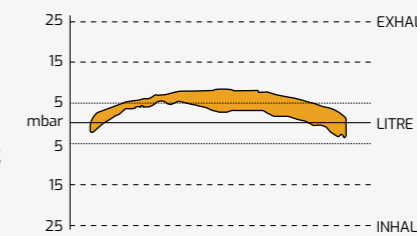

HIGH PERFORMANCE
REGULATOR CERTIFIED
EN 250/2014 FOR COLD WATERS

STAINLESS STEEL
2ND STAGE COVER

CERTIFIED
EN 250/2014
FOR COLD WATERS



1ST STAGE
T10-SC CROMO
2ND STAGE
GALAXY

TOTAL WEIGHT

T10 SC CROMO/GALAXY INT HOSE INCLUDED: 1.055 g | 2 lb 5 Oz

T10 SC CROMO/GALAXY DIN HOSE INCLUDED: 937 g | 2 lb 1 oz



TECHNICAL FEATURES
1ST STAGE

- Hyperbalanced diaphragm (Watertight chamber on T10-SC)
- 2 HP 7/16 UNF ports
- 4 MP 3/8 UNF ports
- **Operating pressure:**
INT version: 230 BAR | 3.336 PSI
DIN version: 300 BAR | 4.351 PSI
Calibration pressure: 10 BAR | 146 PSI
- High-capacity conical filter in chemically nickel-plated spherical bronze
- Removable nozzle in AISI 316 steel
- Hyperbalancing system
- Anti-pressure drop pneumatic spring
- Stainless steel calibration spring with micropeening treatment
- Low-friction technopolymer slider shaft
- **Quantity of air supplied:** 4500 l/min | 159 cu ft/min

TECHNICAL FEATURES
2ST STAGE

- Pneumatically balanced
- Adjustable Venturi
- Adjustable inhalation effort
- Patented elliptical diaphragm
- Patented low-friction lever
- Air delivery system without injector
- Adjuster knob coated with dual OR
- Internal heat exchanger
- Cap opening with Cam-lock
- Noise-absorbing technopolymer body
- Removable technopolymer deflector
- Removable mechanics
- **COMBINATION PERFORMANCE**
- Average Cracking effort 3.5 mBAR | 1.41 inwc
- Average breathing effort 0.6 J/l
- **JACKETED HOSE**
- Extremely light and flexible
weight: 153 g | 5.4 oz
- **CERTIFICATION**
- EN250/2014 for cold water

Very high-performance regulator, engineered in Italy with the best technology available. Ideal for seasoned or professional divers who need extremely high performing equipment that is

both simple and resistant, without any of the usual accessories that may get damaged. The T10-SC features a watertight chamber designed for cold water use. Chrome finishing.

CODE	PRODUCT	STYLE	CASE PACK
HX845000	T10-SC CROMO / GALAXY (INT)	INT	1
HX845100	T10-SC CROMO / GALAXY (DIN)	DIN	1



SPARE PARTS

CODE	PRODUCT
HZ800045	MAINTENANCE KIT for T10/T10-SC INT/DIN
HZ820080	MAINTENANCE KIT for MASTER/GALAXY/ELLIPSE BALANCED
HZ830035	DIN ASSEMBLY for T10/T10-SC



Certification EN250/2014 for cold water
The T10-SEAL CHAMBER 1ST stage is environmentally sealed, protecting it against icing in cold water and against contamination from particulate matter in silty conditions.

RESULTS: INHALE PRESSURE, EXHALE PRESSURE AND EXT WORK OF BREATHING

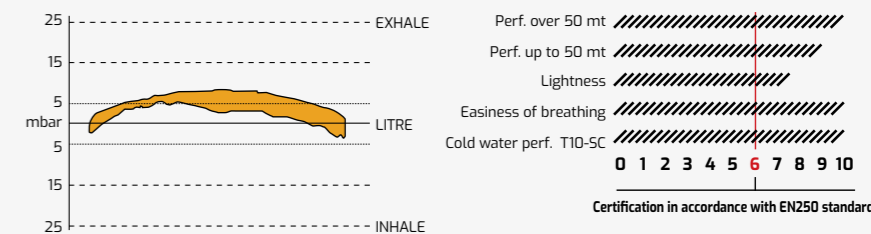

PVD COATING TREATMENT | TITANIUM 2ND STAGE COVER | HIGH PERFORMANCE REGULATOR | CERTIFIED EN 250/2014 FOR COLD WATERS

SPECIALIZED Retailer Product | MADE IN ITALY

1ST STAGE T10-SC PVD 2ND STAGE MASTER BALANCED

TOTAL WEIGHT

INT VERSION HOSE INCLUDED: 1.080 g | 2 lb 6 oz
 DIN VERSION HOSE INCLUDED: 962 g | 2 lb 2 oz



TECHNICAL FEATURES 1ST STAGE

- Hyperbalanced diaphragm (Watertight chamber on T10-SC)
- 2 7/16" HP ports UNF
- 4 3/8" LP ports UNF
- **Operating pressure:**
INT version: 230 BAR | 3.336 PSI
DIN version: 300 BAR | 4.351 PSI
Calibration pressure: 10 BAR | 146 PSI
- Body coated with PVD process
- High-capacity conical filter in chemically nickel-plated spherical bronze
- Removable nozzle in AISI 316 steel
- Hyperbalancing system
- Anti-pressure drop pneumatic spring
- Stainless steel calibration spring with micropeening treatment
- Low-friction technopolymer slider shaft
- **Quantity of air supplied:** 4,500 l/min 159 cu ft/min

TECHNICAL FEATURES 2ST STAGE

- Adjustable pneumatical balanced
- Adjustable Venturi
- Adjustable inhalation effort
- Patented elliptical diaphragm
- Patented low-friction lever
- Air delivery system without injector
- Adjuster knob coated with PVD process with dual OR Laser-etched titanium front piece
- Internal heat exchanger
- Cap opening with Cam-lock
- Noise-absorbing technopolymer body
- Removable technopolymer deflector
- Removable mechanics
- **COMBINATION PERFORMANCE**
- Average Cracking effort: 1.41 inwc | 3.5 mBAR
- Average breathing effort 0.6 J/l
- **JACKETED HOSE**
- Extremely light and flexible
- **weight:** 5.4 oz / 153 g
- **CERTIFICATION**
- EN250/2014 for cold water

Performance, ergonomic reliability, and ease of maintenance make this regulator a product for true diving professionals. Instructors, guides, dive operators, and researchers will find the answer they need in the Master. The first stage stands out from the range of Cressi balanced diaphragm regulators because the mechanism is arranged on an axis perpendicular to the axis of air entry, creating a "T" shape. The advantages of this particular design include

better arrangement of the hoses and less space occupied (especially in SC versions for cold water). What's more, this makes it remarkably easy to inspect and access the mechanism to improve maintenance and calibration operations. It features a larger, high-efficiency conical filter, and the valves are arranged more easily on the tank. The Master second stage is installed with the exceptional and proven Cressi balanced valve to ensure minimum inhalation effort.

CODE	PRODUCT	STYLE	CASE PACK
HX830000	T10-SC PVD / MASTER (INT)	INT	1
HX830100	T10-SC PVD / MASTER (DIN 300)	DIN	1

SPARE PARTS

CODE	PRODUCT
HZ800045	MAINTENANCE KIT for T10/T10-SC INT/DIN
HZ820080	MAINTENANCE KIT for MASTER/GALAXY/ELLIPSE BALANCED
HZ830035	DIN ASSEMBLY for T10/T10-SC



ELITE CASE INCLUDED

COLD WATERS CERTIFIED PRODUCT

Certification EN250/2014 for cold water. The T10-SEAL CHAMBER 1ST stage is environmentally sealed, protecting it against icing in cold water and against contamination from particulate matter in silty conditions.

PVD COATING

PVD IS AN ENVIRONMENTALLY FRIENDLY PROCESS THAT PROVIDES BRILLIANT AND DURABLE DECORATIVE FINISHES. BENEFITS: PVD OFFERS TOP-NOTCH FINISHES THAT PROVIDE A SUPERIOR LOOK TO THE MATERIAL. PVD IS UV RESISTANT AND CHEMICAL RESISTANT.

RESULTS: INHALE PRESSURE, EXHALE PRESSURE AND EXT WORK OF BREATHING

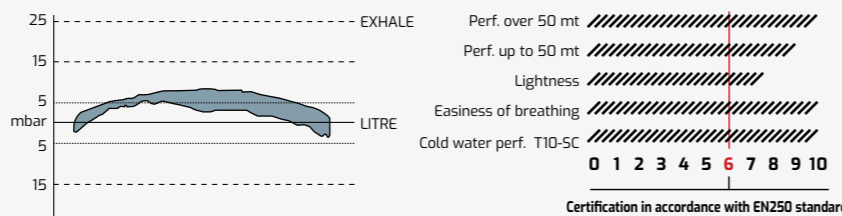

Certification in accordance with EN250 standard

HIGH PERFORMANCE REGULATOR | STAINLESS STEEL 2ND STAGE COVER | CERTIFIED EN 250/2014 FOR COLD WATERS

SPECIALIZED Retailer Product | MADE IN ITALY

1ST STAGE T10-SC CROMO 2ND STAGE MASTER CROMO

TOTAL WEIGHT

INT VERSION HOSE INCLUDED: 1.080 g | 2 lb 6 oz
 DIN VERSION HOSE INCLUDED: 962 g | 2 lb 2 oz



TECHNICAL FEATURES 1ST STAGE

- Hyperbalanced diaphragm (Watertight chamber on T10-SC)
- 2 7/16" HP ports UNF - 4 3/8" LP ports UNF
- **Operating pressure:**
INT version: 230 BAR | 3.336 PSI
DIN version: 300 BAR | 4.351 PSI
Calibration pressure: 10 BAR | 146 PSI
- High-capacity conical filter in chemically nickel-plated spherical bronze
- Removable nozzle in AISI 316 steel
- Hyperbalancing system
- Anti-pressure drop pneumatic spring
- Stainless steel calibration spring with micropeening treatment
- Low-friction technopolymer slider shaft
- **Quantity of air supplied:** 4,500 l/min 159 cu ft/min

TECHNICAL FEATURES 2ST STAGE

- Pneumatically balanced
- Adjustable Venturi
- Adjustable inhalation effort
- Patented elliptical diaphragm
- Patented low-friction lever
- Air delivery system without injector
- Adjuster knob coated with PVD process with dual OR Internal heat exchanger
- Cap opening with Cam-lock
- Noise-absorbing technopolymer body
- Removable technopolymer deflector
- Removable mechanics
- **COMBINATION PERFORMANCE**
- Average Cracking effort: 1.41 inwc | 3.5 mBAR
- Average breathing effort: 0.6 J/l
- **JACKETED HOSE**
- Extremely light and flexible
- **Weight:** 5.4 oz / 153 g
- **CERTIFICATION**
- EN250/2014 for cold water

CODE	PRODUCT	STYLE	CASE PACK
HX840000	T10-SC CROMO / MASTER CROMO (INT)	INT	1
HX840100	T10-SC CROMO / MASTER CROMO (DIN)	DIN	1

SPARE PARTS

CODE	PRODUCT
HZ800045	MAINTENANCE KIT for T10/T10-SC INT/DIN
HZ820080	MAINTENANCE KIT for MASTER/GALAXY/ELLIPSE BALANCED
HZ830035	DIN ASSEMBLY for T10/T10-SC



PROTECTIVE HARD CASE

COLD WATERS CERTIFIED PRODUCT

Certification EN250/2014 for cold water. The T10-SEAL CHAMBER 1ST stage is environmentally sealed, protecting it against icing in cold water and against contamination from particulate matter in silty conditions.

VERSION TECHNICALLY IDENTICAL TO THE T10 MASTER WITH A DURABLE SATIN CHROME FINISH ON THE FIRST STAGE AND A BRUSHED STAINLESS STEEL CAP ON THE SECOND STAGE.

RESULTS: INHALE PRESSURE, EXHALE PRESSURE AND EXT WORK OF BREATHING

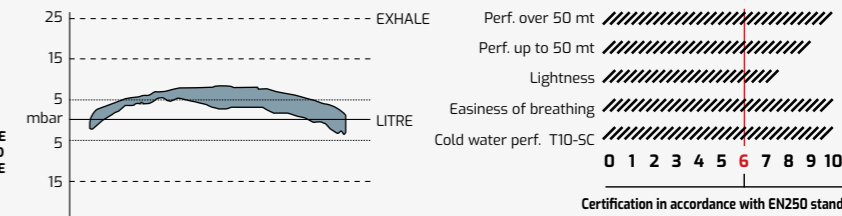

Certification in accordance with EN250 standard

CRESSI 3RD GENERATION FIRST STAGE | FIRST STAGE ADJUSTABLE PISTON | CERTIFIED EN 250/2014 FOR COLD WATERS

SPECIALIZED Retailer Product | MADE IN ITALY

1ST STAGE AC25m | 2ND STAGE MASTER CROMO

TOTAL WEIGHT

INT VERSION HOSE INCLUDED: 1123 g | 2 lb 14 oz



SCUBALAB BEST BUY 2020

TECHNICAL FEATURES 1ST STAGE

- 3rd generation Cressi's IP adjustable balanced piston first stage
- 2x 7/16" HP ports UNF
- 5x 3/8" LP ports UNF, 1 port on turret top
- **Operating pressure:**
 INT version: 230 BAR | 3.336 PSI
 DIN version: 300 BAR | 4.351 PSI
Calibration pressure: 9.8-10 BAR | 142-146 PSI
- 360° revolving head
- Realized in brass-coated, with a matte finish
- The sintered conical filter protects from any impurity
- **Flow rate:** 4.500 l/min | 159 cu ft/min

TECHNICAL FEATURES 2ST STAGE

- Pneumatically balanced
- Adjustable Venturi
- Adjustable inhalation effort
- Patented elliptical diaphragm
- Patented low-friction lever
- Air delivery system without injector
- Adjuster knob coated with PVD process with dual OR Laser-etched titanium front piece
- Internal heat exchanger
- Cap opening with Cam-lock
- Noise-absorbing technopolymer body
- Removable technopolymer deflector
- Removable mechanics
- **COMBINATION PERFORMANCE**
- Average breathing effort 0.78 J/l
- **CERTIFICATION**
- EN250/2014 >10°C | 50 F



ELITE CASE INCLUDED

The AC25 is the third generation of Cressi's IP adjustable balanced piston first stage. It features 2 high-pressure ports and 5 low-pressure ports. 4 low-pressure ports are located on a rotating turret that ensures that regulator and instrument connections are always in the right position. The fifth port is a co-axial Hi-Flow port and is located at the top of the turret. The rotating turret swivels on 360° axis and features 5 low-pressure ports designed to allow the use of more connections without interfering between them. It features the external direct

IP adjustment system that can be set using a simple Allen key. The hi-flow conic shape filter is the same for INT and DIN. The spring and the spring bush are coated preventing rust. Its technologically advanced design delivers consistent intermediate pressure and high performance even with low tank pressures. The AC25m features a matte finish, in gun metal-coated brass. It is combined with the Master Cromo, the pneumatic balanced 2nd stage that features an elliptical shape and a lateral knob for Venturi adjustment.

CODE	PRODUCT	STYLE	CASE PACK
HX900000	AC25m / MASTER CROMO (INT)	INT	1



SPARE PARTS

CODE	PRODUCT
HZ850017	MAINTENANCE KIT for AC25m/AC25g
HZ820080	MAINTENANCE KIT for MASTER/GALAXY/ELLIPSE BALANCED
HZ850018	COMPLETE DIN CONNECTION for AC25m

RESULTS: INHALE PRESSURE, EXHALE PRESSURE AND EXT WORK OF BREATHING

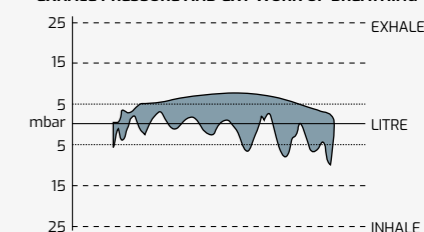

HIGH PERFORMANCE
REGULATOR

CERTIFIED
EN 250/2014
FOR COLD WATERS

COLD WATERS
CERTIFIED PRODUCT

SPECIALIZED
Retailer Product

MADE IN
ITALY

1ST STAGE
MC9-SC

2ND STAGE
COMPACT PRO

TOTAL WEIGHT

INT VERSION HOSE INCLUDED: 946 g | 2 lb 1 oz

DIN VERSION HOSE INCLUDED: 803 g | 1 lb 2 oz



TECHNICAL FEATURES
1ST STAGE

- Hyperbalanced diaphragm (seal chamber for MC9-SC)
- 2 7/16" HP ports UNF
- 4 3/8" LP ports UNF
- Operating pressure:**
INT version: 230 BAR | 3.336 PSI
Calibration pressure: 9.8-10 BAR | 142-146 PSI
- Brass body Electroless Nickel plated
- High capacity conical filter electroless nickel plated
- Body protection in polyurethane thermoplastic
- Aisi 316 removable nozzle
- Hyper-balancing
- Anti-pressure drop pneumatic spring
- Setting spring:** stainless steel with micropeening treatment
- Replaceable cylinder with anti-friction and anti-corrosion properties
- Elastomer protector
- Flow rate:** 4.500 l/min | 159 cu ft/min

TECHNICAL FEATURES
2ST STAGE

- Downstream system
- Adjustable Venturi effect
- Patented antifriction lever
- Thermoconductive technopolymer body
- Big purge button
- Anti-scratch surface
- Bayonet-type cap holder with security lock
- Stainless steel cover
- Removable exhaust tee without tools
- COMBINATION PERFORMANCE**
- Average Cracking effort: 6.0 mBAR | 2.41 inwc
- Average breathing effort 1.1 J/l
- JACKETED HOSE**
- Extremely light and flexible
- Weight:** 153 g | 5.4 oz
- CERTIFICATION**
- EN250/2014 for cold water



In order to achieve extremely high performance in low temperature environments, the second stage in particular was designed with the special Thermoconductive Thermoplastic Neopolymer that has the capacity to transfer heat like a metal while preserving the design flexibility, chemical resistance, and physical

and mechanical properties of a conventional thermoplastic. This makes it possible to drastically reduce the weight while delivering heat conductivity on a par with metal cases. Thanks to this material and a specially conceived purge valve, it passes all the tests for use in cold water with flying colors.

CODE	PRODUCT	STYLE	CASE PACK
HX782000	MC9-SC / COMPACT PRO (INT)	INT	1
HX782100	MC9-SC / COMPACT PRO (DIN)	DIN	1



SPARE PARTS

CODE	PRODUCT
HZ800047	MAINTENANCE KIT for MC9/MC9-SC/MC5 INT/DIN
HZ780060	MAINTENANCE KIT for COMPACT/COMPACT PRO
HZ782096	PURGE BUTTON (BLACK) for COMPACT PRO

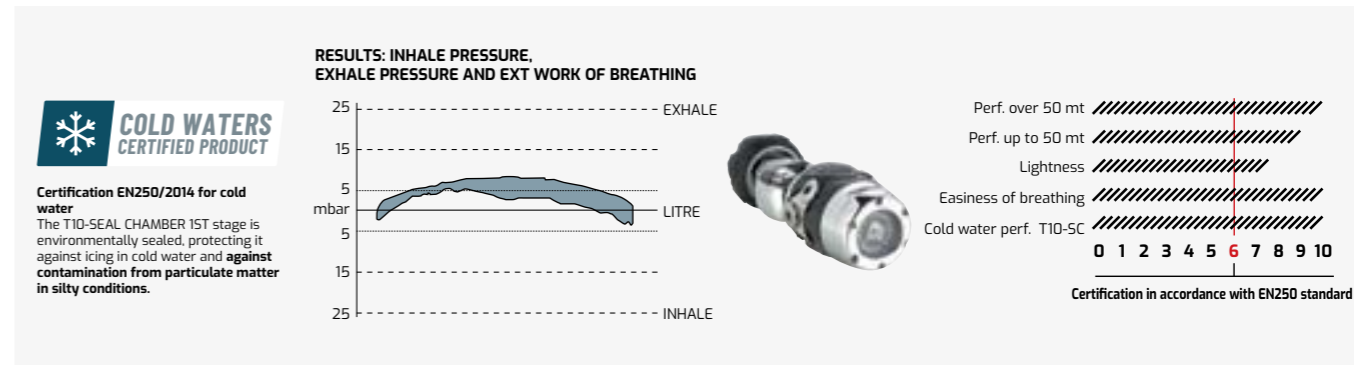

CRESSI 3RD GENERATION FIRST STAGE | FIRST STAGE ADJUSTABLE PISTON | CERTIFIED EN 250/2014 FOR COLD WATERS

1ST STAGE AC25g **2ND STAGE COMPACT**

TOTAL WEIGHT
INT VERSION HOSE INCLUDED: 1193 g | 1 lb 10 oz



The AC25 is the third generation of Cressi's IP adjustable balanced piston first stage. It features 2 high-pressure ports and 5 low-pressure ports. 4 low-pressure ports are located on a rotating turret that ensures that regulator and instrument connections are always in the right position. The fifth port is a co-axial Hi-Flow port and is located at the top of the turret. The rotating turret swivels on 360° axis and features 5 low-pressure ports designed to allow the use of more connections without interfering between them. It features the external direct

IP adjustment system that can be set using a simple Allen key. The hi-flow conic shape filter is the same for INT and DIN. The spring and the spring bush are coated preventing rust. Its technologically advanced design delivers consistent intermediate pressure and high performance even with low tank pressures. The AC25g features a glossy finish, in coated brass. It is combined with the Compact, the downstream 2nd stage popular for its compact design and lightness.

CODE	PRODUCT	STYLE	CASE PACK
HX901000	AC25g / COMPACT (INT)	INT	1

SPARE PARTS

CODE	PRODUCT
HZ850017	MAINTENANCE KIT for AC25m/AC25g
HZ820080	MAINTENANCE KIT for MASTER/GALAXY/ELLIPSE BALANCED
HZ850018	COMPLETE DIN CONNECTION for AC25m

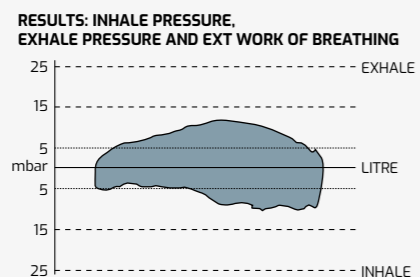

PROTECTIVE HARD CASE

TECHNICAL FEATURES 1ST STAGE

- 3rd generation Cressi's IP adjustable balanced piston first stage
- 2x 7/16" HP ports UNF
- 5x 3/8" LP ports UNF, 1 port on turret top
- **Operating pressure:**
INT version: 230 BAR | 3.336 PSI
DIN version: 300 BAR | 4.351 PSI
Calibration pressure: 9.8-10 BAR | 142-146 PSI
- 360° revolving head
- Realized in brass-coated, with a glossy finish
- The sintered conical filter protects from any impurity
- **Flow rate:** 4.500 l/min | 159 cu ft/min

TECHNICAL FEATURES 2ST STAGE

- Downstream system
- Adjustable Venturi effect
- Patented antifriction lever
- Large purge button
- Anti-scratch surface
- Bayonet-type cap holder with security lock
- Removable exhaust tee without tools
- **COMBINATION PERFORMANCE**
- Average breathing effort 1.4J/l
- **CERTIFICATION**
- EN250/2014 >10°C | 50 F



CRESSI 3RD GENERATION FIRST STAGE | FIRST STAGE ADJUSTABLE PISTON | CERTIFIED EN 250/2014 FOR COLD WATERS

1ST STAGE MC9 **2ND STAGE COMPACT**

TOTAL WEIGHT
INT VERSION HOSE INCLUDED: 878 g | 2 lb 1 oz



This premiere travel regulator packs maximum performance into minimum space. A true featherweight second stage, the Compact is built from lightweight techno-

polymers to eliminate jaw fatigue. Easy to pack and easy to dive, the Compact includes dive/pre-dive Venturi switch for managing freeflow and maximizing performance at depth.

CODE	PRODUCT	STYLE	CASE PACK
HX783020	MC9 / COMPACT (INT) - BLUE	INT	1
HX783051	MC9 / COMPACT (INT) - GREY	INT	1
HX783151	MC9 / COMPACT (INT) - WHITE	INT	1

SPARE PARTS

CODE	PRODUCT
HZ800047	MAINTENANCE KIT for MC9/MC9-SC/MC5 INT/DIN
HZ780060	MAINTENANCE KIT for COMPACT/COMPACT PRO
HZ780064	PURGE BUTTON (BLACK) for COMPACT
HZ780067	PURGE BUTTON (WHITE) for COMPACT

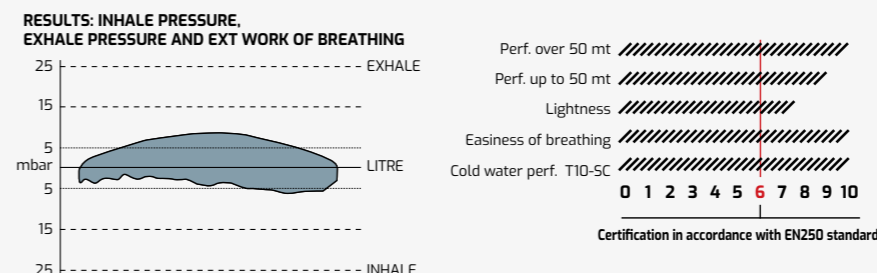

PACKAGING

TECHNICAL FEATURES 1ST STAGE

- Hyperbalanced diaphragm
- 2 7/16" HP ports UNF
- 4 3/8" LP ports UNF
- **Operating pressure:**
INT version: 230 BAR | 3.336 PSI
Calibration pressure: 9.8-10 BAR | 142-146 PSI
- Brass body Electroless Nickel plated
- High capacity conical filter electroless nickel plated
- Aisi 316 removable nozzle
- Hyper-balancing
- Anti-pressure drop pneumatic spring
- **Setting spring:** stainless steel with micropeening treatment
- Replaceable cylinder with anti-friction and anti-corrosion properties
- Elastomer protector
- **Flow rate:** 4.500 l/min | 159 cu ft/min

TECHNICAL FEATURES 2ST STAGE

- Downstream system
- Adjustable Venturi effect
- Patented antifriction lever
- Big purge button
- Anti-scratch surface
- Bayonet-type cap holder with security lock
- Removable exhaust tee without tools
- **COMBINATION PERFORMANCE**
- Average Cracking effort: 6.0 mBAR | 2.41 inwc
- Average breathing effort 1.1 J/l
- **JACKETED HOSE**
- Extremely light and flexible
- **Weight:** 153 g | 5.4 oz
- **CERTIFICATION**
- EN250 2014 A>10°C | 50 F

LIGHTWEIGHT
REGULATOR SETS

CERTIFIED
EN 250/2014
FOR COLD WATERS

1ST STAGE
AC2

2ND STAGE
COMPACT

TOTAL WEIGHT

INT VERSION HOSE INCLUDED: 923 g | 2 lb 0.5 oz



TECHNICAL FEATURES
1ST STAGE

- Piston design
- 1 7/16" HP ports UNF
- 4 3/8" LP ports UNF
- **Operating pressure:**
INT version: 230 BAR | 3.336 psi
Calibration pressure: 9.8-10 BAR | 142-146 PSI
- Brass body Electroless Nickel plated
- High capacity conical filter electroless nickel plated
- **Long lasting piston:** AISI 316 stainless steel
- Extremely easy in maintenance since IP is adjustable from the outside
- Stainless steel spring
- **Flow rate:** 2.100 l/min | 74.16 cu ft/min

TECHNICAL FEATURES
2ST STAGE

- Downstream system
- Adjustable Venturi effect
- Patented antifriction lever
- Big purge button
- Anti-scratch surface
- Bayonet-type cap holder with security lock
- Removable exhaust tee without tools
- **COMBINATION PERFORMANCE**
- Average Cracking effort: 6.0m BAR | 2.41 inwc
- Average breathing effort 1.2 J/l
- **JACKETED HOSE**
- Extremely light and flexible
- **Weight:** 153 g | 5.4 oz
- **CERTIFICATION**
- EN250 2014 A>10°C

DIRECT IP
ADJUSTMENT
SYSTEM (NO
SHIMS REQUIRED)

EXTERIOR LP
REGULATION
FACILITATES
MANAGING
ADJUSTMENTS
AND TECHNICAL
MAINTENANCE



PACKAGING

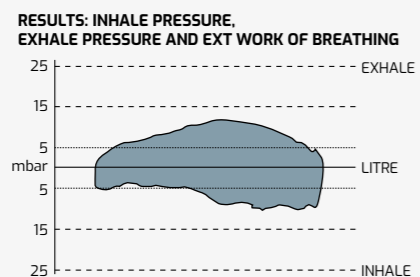

ALSO FOR RENTAL

MADE IN ITALY

RELIABLE
DESIGN

CERTIFIED
EN 250/2014
FOR COLD WATERS

1ST STAGE
AC2

2ND STAGE
XS2

TOTAL WEIGHT

INT VERSION HOSE INCLUDED: 994 g | 2 lb 3 oz



TECHNICAL FEATURES
1ST STAGE

- Piston design
- 1 7/16" HP ports UNF
- 4 3/8" LP ports UNF
- **Operating pressure:**
INT version: 230 BAR | 3.336 PSI
Calibration pressure: 9.8-10 BAR | 142-146 PSI
- Brass body Electroless Nickel plated
- High capacity conical filter electroless nickel plated
- **Long lasting piston:** AISI 316 stainless steel
- Extremely easy in maintenance since IP is adjustable from the outside
- Stainless steel spring
- **Flow rate:** 2.100 l/min | 74.16 cu ft/min

TECHNICAL FEATURES
2ST STAGE

- Downstream system
- Adjustable Venturi effect
- Easy maintenance
- Adjustable intermediate pressure from the out side of the regulator due to our patented design
- **COMBINATION PERFORMANCE**
- **Average Cracking effort:** 10 mBAR | 4 inwc
- Average breathing effort 1.5 J/l
- **JACKETED HOSE**
- Extremely light and flexible
- **Weight:** 53 g | 1.87 oz
- **CERTIFICATION**
- EN250 2014 A>10°C

DIRECT IP
ADJUSTMENT
SYSTEM (NO
SHIMS REQUIRED)

EXTERIOR LP
REGULATION
FACILITATES
MANAGING
ADJUSTMENTS
AND TECHNICAL
MAINTENANCE



PACKAGING

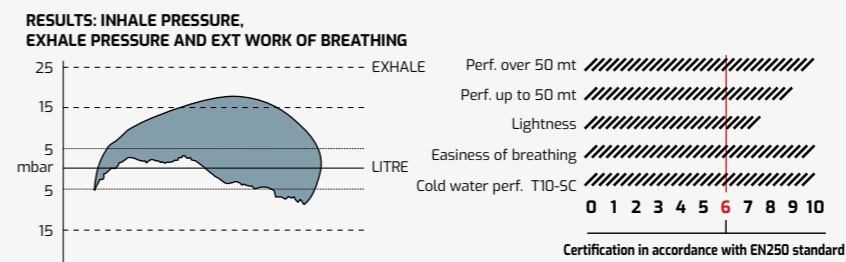

LIGHTWEIGHT
REGULATOR SETS

CERTIFIED
EN 250/2014
FOR COLD WATERS



1ST STAGE AC2 2ND STAGE COMPACT OCTOPUS OCTOPUS COMPACT



TECHNICAL FEATURES 1ST STAGE

- Unbalanced piston
- 1 outlets HP 7/16 UNF
- 4 outlets MP 3/8 UNF
- **Service pressure:** 300 BAR (4350 PSI) DIN version, 232 BAR (3365 PSI) Yoke version
- **Calibration pressure:** 9.5-10 BAR
- Brass body Electroless Nickel plated
- High capacity conical filter electroless nickel plated
- Aisi 316 long lasting piston
- Easy external direct IP adjustment system
- Stainless steel spring
- **Flow rate:** 2100 l/min
- **Yoke version weight:** 635 g.
- **DIN version weight:** 495 g.

TECHNICAL FEATURES 2ST STAGE

- Downstream system
- Adjustable Venturi effect
- Patented antifriction lever
- Big purge button
- Anti-scratch surface
- Bayonet-type cap holder with security lock
- Removable exhaust tee without tools
- **Weight without hose:** 135 g.

DIRECT IP
ADJUSTMENT
SYSTEM (NO
SHIMS REQUIRED)



EXTERIOR LP
REGULATION
FACILITATES
MANAGING
ADJUSTMENTS
AND TECHNICAL
MAINTENANCE



CODE	PRODUCT	STYLE	CASE PACK
HY787051	AC2 / COMPACT + OCTOPUS COMPACT (INT)		1

SPARE PARTS

CODE	PRODUCT
HZ730150	MAINTENANCE KIT for AC2
HZ780060	MAINTENANCE KIT for COMPACT/COMPACT PRO
HZ780067	PURGE BUTTON (BLACK) for COMPACT
HZ780066	PURGE BUTTON (YELLOW) for COMPACT



RESULTS: INHALE PRESSURE, EXHALE PRESSURE AND EXT WORK OF BREATHING

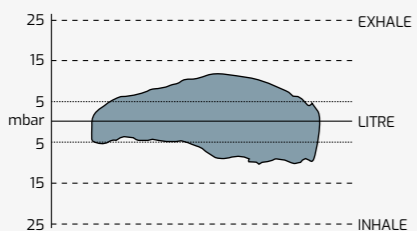

T10-SC CROMO *



CODE	PRODUCT
HZ991006	T10-SC CROMO INT 1st STAGE ONLY
KZ770098	T10-SC CROMO DIN 1st STAGE ONLY

DESCRIPTION:
Hyperbalanced T shape diaphragm 1st stage with seal chamber system, chrome finishing.

*See compatibility warnings!

AC25m *



CODE	PRODUCT
HZ900003	AC25m BALANCED PISTON MATTE 1st STAGE (INT)

DESCRIPTION:
Revolving turret balanced piston 1st stage, gun-metal chrome finishing, external IP direct adjustment system.

*See compatibility warnings!

MC9-SC *



CODE	PRODUCT
HZ820095	MC9-SC (INT) 1st STAGE
HZ820096	MC9-SC (DIN) 300 BAR 1st STAGE

DESCRIPTION:
Hyperbalanced in-line shape diaphragm 1st stage with seal chamber system.

*See compatibility warnings!

* COMPATIBILITY WARNINGS !

The 1st stages and hoses are sold ONLY as a replacement for the regulator combination for which its use is envisaged under the regulatory requirements in force. Therefore it may only be used as a replacement for the combination with second stages called for in the EC certificate for the type that concern it as well as the EC declaration of conformity for the product according to Regulation (EU) 2016/425, which can be viewed at www.cressi.com. Cressi Sub declines all responsibility for any other use that does not conform with the requirements dictated by the regulations in force.

The combinations of the certified Cressi regulators are contained in the last page of the Regulator user manual which can be read or downloaded from www.cressi.com using the following QR Code:



NATURAL AND EFFORTLESS BREATHING | PNEUMATICALLY BALANCED VALVE | CERTIFIED EN 250/2014 FOR COLD WATERS

COLD WATERS CERTIFIED PRODUCT

SPECIALIZED Retailer Product

MADE IN ITALY

OCTOPUS MG BALANCED



TECHNICAL FEATURES

- Pneumatically balanced
- Venturi effect adjustment
- Patented elliptical membrane
- Patented low-friction lever
- Air delivery system without injector
- Internal heat exchange
- Cam-lock system to open the case
- Body in noise-absorbent technopolymer
- Removable technopolymer deflector
- Removable mechanical parts
- **Total weight:** 335 g | 12 oz
- **JACKETED HOSE**
- Extremely light and flexible
- **Weight:** 153 g | 5.4 oz
- **CERTIFICATION**
- **Certification Annex B EN 250:** 2014 for cold water z

CODE	PRODUCT	CASE PACK
HX880000	OCTOPUS MG BALANCED	1

SPARE PARTS

CODE	PRODUCT
HZ780083	PURGE BUTTON (YELLOW) for OCTOPUS MG BALANCED
HZ820080	MAINTENANCE KIT for MASTER/GALAXY/ELLIPSE BALANCED

QUICK AND EASY DEPLOYMENT | CERTIFIED EN 250/2014 FOR COLD WATERS

OCTOPUS COMPACT PRO



TECHNICAL FEATURES

- Downstream system
- Adjustable venturi effect
- Patented antifriction lever
- Thermoconductive technopolymer body
- Big purge button
- Anti-scratch surface
- Bayonet-type cap holder with security lock
- Stainless steel cover
- Removable exhaust tee without tools
- **Total weight:** 293 g | 10.3 oz
- **JACKETED HOSE**
- Extremely light and flexible
- **Weight:** 153 g | 5.4 oz
- **CERTIFICATION**
- **Annex B EN 250:** 2014 for cold water

CODE	PRODUCT	CASE PACK
HX789500	OCTOPUS COMPACT PRO	1

SPARE PARTS

CODE	PRODUCT
HZ780060	MAINTENANCE KIT for COMPACT/COMPACT PRO
HZ780052	PURGE BUTTON (YELLOW) for OCTOPUS COMPACT

QUICK AND EASY DEPLOYMENT | CERTIFIED EN 250/2014

OCTOPUS COMPACT



TECHNICAL FEATURES

- Pneumatically balanced
- Venturi effect adjustment
- Patented elliptical membrane
- Patented low-friction lever
- Air delivery system without injector
- Internal heat exchange
- Cam-lock system to open the case
- Body in noise-absorbent technopolymer
- Removable technopolymer deflector
- Removable mechanical parts
- **Total weight:** 288 g | 10.2 oz
- **JACKETED HOSE**
- Extremely light and flexible
- **Weight:** 153 g | 5.4 oz
- **CERTIFICATION**
- **Certification Annex B EN 250:** 2014 > 10° C | 50 F

CODE	PRODUCT	CASE PACK
HX789000	OCTOPUS COMPACT	1

SPARE PARTS

CODE	PRODUCT
HZ780060	MAINTENANCE KIT for COMPACT/COMPACT PRO
HZ780066	PURGE BUTTON (YELLOW) for COMPACT

ULTRA RELIABLE DESIGN | CERTIFIED EN 250/2014

OCTOPUS XS2



TECHNICAL FEATURES

- Downstream system
- Adjustable venturi effect
- Easy maintenance
- **Total weight:** 359 g | 12.7 oz
- **JACKETED HOSE**
- Extremely light and flexible
- **Weight:** 153 g | 5.4 oz
- **CERTIFICATION**
- **Annex B EN 250:** 2014 A>10°C | 50 F

Proven and highly affordable, the XS Octopus is ideal for any diver looking for maximum value. Its

low maintenance and ultra reliable design also make it a favorite among dive schools and rental centers.

CODE	PRODUCT	CASE PACK
HX770098	OCTOPUS XS2	1

SPARE PARTS

CODE	PRODUCT
HZ790090	MAINTENANCE KIT for XS/XS2/OCTOPUS XS

CRESSI ALSO FOR RENTAL | MADE IN ITALY

REGULATOR

| COMPARISON CHART



	T10-SC CROMO GALAXY-R	T10-SC CROMO GALAXY	T10-SC PVD MASTER BALANCED	T10-SC CROMO MASTER CROMO	AC25M MASTER CROMO
INT version available	Yes	Yes	Yes	Yes	Yes
DIN version available in America	Yes	Yes	Yes	Yes	No
Weight (hose included)	INT 1.055 g 2 lb 5 oz DIN 937 g 2 lb 1 oz	INT 1055 g 2 lb 5 oz DIN 937 g 2 lb 1 oz	INT 1080 g 2 lb 6 oz DIN 962 g 2 lb 2 oz	INT 1080 g 2 lb 6 oz DIN 962 g 2 lb 2 oz	INT 1293 g 2 lb 14 oz
Certified for cold water	EN250/2014 <10° C 50 F	EN250/2014 <10° C 50 F	EN250/2014 <10° C 50 F	EN250/2014 <10° C 50 F	EN250/2014 >10° C 50 F
PERFORMANCE					
Working pressure	INT 0-232 BAR 0-3,365 PSI DIN 0-300 BAR 0-4,350 PSI	INT 0-232 BAR 0-3,365 PSI DIN 0-300 BAR 0-4,350 PSI	INT 0-232 BAR 0-3,365 PSI DIN 0-300 BAR 0-4,350 PSI	INT 0-232 BAR 0-3,365 PSI DIN 0-300 BAR 0-4,350 PSI	INT 0-232 BAR 0-3,365 PSI
Calibration pressure	9.8-10 BAR 142-146 PSI	9.8-10 BAR 142-146 PSI	9.8-10 BAR 142-146 PSI	9.8-10 BAR 142-146 PSI	9.8-10 BAR 142-146 PSI
Air supply (Air pressure at 200-150 BAR)	159 cu ft/min 4500 l/min	159 cu ft/min 4500 l/min	159 cu ft/min 4500 l/min	159 cu ft/min 4500 l/min	99 cu ft/min 2800 l/min
Average cracking effort	3.5 mBAR 1.41 inwc	3.5 mBAR 1.41 inwc	3.5 mBAR 1.41 inwc	3.5 mBAR 1.41 inwc	
Average inhalation effort	3 mBAR	3 mBAR	3 mBAR	3 mBAR	9.9 mBAR
Average exhalation effort	7 mBAR	7 mBAR	7 mBAR	7 mBAR	8.1 mBAR
Average breathing effort	0.6 J/l	0.6 J/l	0.6 J/l	0.6 J/l	0.78 J/l
1ST STAGE					
Type	Hyperbalanced Diaphragm	Hyperbalanced Diaphragm	Hyperbalanced Diaphragm	Hyperbalanced Diaphragm	Balanced Piston
HP ports	2 7/16" UNF	2 7/16" UNF	2 7/16" UNF	2 7/16" UNF	2 7/16" UNF
LP ports	4 3/8" UNF	4 3/8" UNF	4 3/8" UNF	4 3/8" UNF	5 3/8" UNF
2ND STAGE					
Type	Adjustable Pneumatical Balanced	Pneumatically Balanced	Adjustable Pneumatical Balanced	Adjustable Pneumatical Balanced	Pneumatically Balanced

REGULATOR

| COMPARISON CHART



	MC9-SC COMPACT PRO	AC25G COMPACT	MC9 COMPACT	AC2 COMPACT	AC2 XS2
INT version available	Yes	Yes	Yes	Yes	Yes
DIN version available in America	Yes	No	No	No	No
Weight (hose included)	INT 943 g 2 lb 1 oz	INT 1193 g 2 lb 10 oz	INT 878 g 2 lb 1 oz	INT 923 g 2 lb 0.5 oz	INT 994 g 2 lb 3 oz
Certified for cold water	EN250/2014	EN250/2014 >10° C 50 F	EN250/2014 >10° C 50 F	EN250/2014 >10° C 50 F	EN250/2014 >10° C 50 F
PERFORMANCE					
Working pressure	INT 0-232 BAR 0-3,365 PSI	INT 0-232 BAR 0-3,365 PSI DIN 0-300 BAR 0-4,350 PSI	INT 0-232 BAR 0-3,365 PSI	INT 0-232 BAR 0-3,365 PSI	INT 0-232 BAR 0-3,365 PSI
Calibration pressure	9.8-10 BAR 142-146 PSI	9.8-10 BAR 142-146 PSI	9.8-10 BAR 142-146 PSI	9.8-10 BAR 142-146 PSI	9.8-10 BAR 142-146 PSI
Air supply (air pressure at 200-150 BAR)	159 cu ft/min 4,500 l/min	99 cu ft/min 2800 l/min	159 cu ft/min 4500 l/min	74 cu ft/min 2100 l/min	74 cu ft/min 2100 l/min
Average cracking effort	2.41 inwc 6 mBAR		2.41 inwc 6 mbar	2.41 inwc 6 mbar	4 inwc 10 mbar
Average inhalation effort	5 mBAR	10.1 mBAR	5 mBAR	5 mBAR	12 mBAR
Average exhalation effort	10 mBAR	11.6 mBAR	10 mBAR	10 mBAR	17 mBAR
Average breathing effort	1.1 J/l	1.4 J/l	1.1 J/l	1.2 J/l	1.5 J/l
1ST STAGE					
Type	Hyperbalanced Diaphragm	Balanced Piston	Hyperbalanced Diaphragm	Balanced Piston	Balanced Piston
HP ports	2 7/16" UNF	2 7/16" UNF	2 7/16" UNF	1 7/16" UNF	1 7/16" UNF
LP ports	4 3/8" UNF	5 3/8" UNF	4 3/8" UNF	4 3/8" UNF	4 3/8" UNF
2ND STAGE					
Type	Downstream System	Downstream System	Downstream System	Downstream System	Downstream System



35 WE
MANUFACTURE
QUALITY SINCE
1968

▲ Photo by Jason Washington

PROTECTIVE CASES

360 REGULATOR BAG

The 360 Regulator Bag is a case for protecting scuba diving regulators and octopus. Features an adjustable shoulder strap for carrying your equipment. Made in strong nylon for long lasting use. The foam lining acts as a protective covering. The closure is with YKK zip that ensures a perfect seal.



TECHNICAL FEATURES

- Made in strong nylon for long lasting use
- Foam lining acts as a protective covering
- The closure is with YKK zip that ensures a perfect seal
- Velcro strap on back of case for easy attachment to luggage for travel

CODE	PRODUCT
UB940000	360 REGULATOR BAG - BLACK/BLACK

DIN CONVERSION KIT



AC2



MC9/MC5



T10/T10-SC



INT YOKE UNIVERSAL ADAPTOR
FOR DIN 1ST STAGE

CODE	PRODUCT
HZ735157	DIN ASSEMBLY 300 BAR for AC2
HZ800067	DIN ASSEMBLY 300 BAR for MC5/MC9/MC9-SC
HZ830035	DIN ASSEMBLY for T10/T10-SC
HZ840001	DIN TO YOKE UNIVERSAL ADAPTOR

LP HOSE



CODE	PRODUCT
HZ730225	LP OCTOPUS HOSE (YELLOW) (101.5cm - 40in)
HZ730222	LP REGULATOR HOSE (BLACK) (78cm - 30.5in)

MAGNETIC OCTOPUS HOLDER

The Magnetic Octopus Holder keeps the equipment in its place, close to the jacket. It can be used for the safety octopus, pressure gauge, or for other additional instruments.



CODE
TA700002

LP SAFEFLEX HOSE

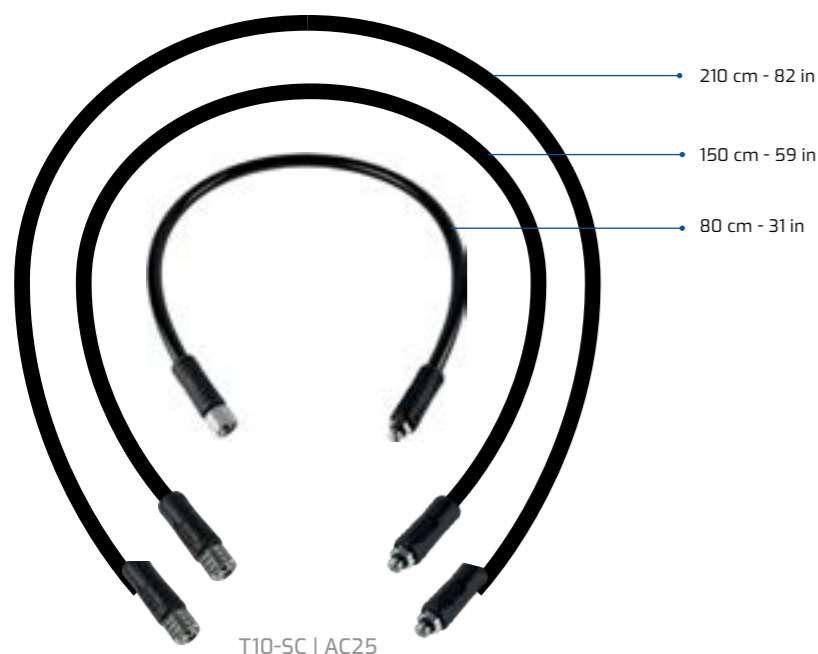

CODE	SIZE
HZ730230	80 cm
HZ730231	150 cm
HZ730232	210 cm

LP HOSE PROTECTOR



CODE	PRODUCT
HZ730224	BLACK
HZ730228	YELLOW

GALAXY PURGE BUTTON



CODE	PRODUCT
HZ820090	PURGE BUTTON for GALAXY-R 2nd STAGE - BLACK
HZ820088	PURGE BOTTON for GALAXY - BLACK
HZ780083	PURGE BUTTON (YELLOW) for OCTOPUS MG BALANCED

COMPACT PRO PURGE BUTTON



CODE	COLOR
HZ782096	Black
HZ780052	Yellow

XS2 COVER



CODE	COLOR
HZ780050	Black/Grey
HZ780051	Black/Yellow

2ND STAGE MOUTHPIECE



CODE
HZ790094



CODE	PRODUCT
VPOSTERTGR	TECHNICAL DRAWING POSTER OF T10SC CROMO/GALAXY-R REGULATOR
VPOSTERTM	TECHNICAL DRAWING POSTER OF T10-SC/MASTER REGULATOR
VPOSTERTMC	TECHNICAL DRAWING POSTER OF T10-SC/MASTER CROMO REGULATOR

MAINTENANCE KITS

In a blister pack, we have included all the components to be changed when performing maintenance on both the first and second stages. Maintenance is only to be performed by Cressi Authorized Service Centers.



1ST STAGE

CODE	PRODUCT
HZ800045	MAINTENANCE KIT for T10/T10-SC INT/DIN
HZ800047	MAINTENANCE KIT for MC9/MC9-SC/MC5 INT/DIN
HZ800070	MAINTENANCE KIT for MC7
HZ850017	MAINTENANCE KIT for AC25m/AC25g
HZ735050	MAINTENANCE KIT for AC10V
HZ730150	MAINTENANCE KIT for AC2

2ND STAGE

CODE	PRODUCT
HZ820080	MAINTENANCE KIT for MASTER/GALAXY/ELLIPSE BALANCED
HZ810067	MAINTENANCE KIT for ELLIPSE (NOT BALANCED)
HZ780060	MAINTENANCE KIT for COMPACT/COMPACT PRO
HZ790090	MAINTENANCE KIT for X5/X52/OCTOPUS X5

SERVICE & REPAIR

COMPLETE SERVICE BAG



CODE	PRODUCT
HZ830102	Service and repair complete kit

- | TECHNICAL FEATURES 2 ST STAGE | TECHNICAL FEATURES 2 ST STAGE |
|---|--|
| <ul style="list-style-type: none"> + full set dynamometric wrench + 1st stage ip setting gauge + threaded bar to tighten the regulator in the vice + yoke nut removing socket and wrench + allen key 6 mm + allen key 7 mm + extraction point tool + tool to remove o-rings + big compass s.c. spanner + antifreeze/s.c. spanner + push tool + ogival tool o-ring bullit + pin spanner + universal push tool + ac2 ip adjusting tool + removing hp seat ac2 + pin punch 110 mm 2 | <ul style="list-style-type: none"> + 5.5 mm socket driver + spring push tool + allen key 4 mm + allen key 6 mm + o-ring removal tool + 2nd stage inline adjuster with ip gauge + 2nd stage setting gauge + small compass spanner + extraction plier |

- JACKETS TOOLS**
- + 12 mm socket wrench
 - + extraction point tool
 - + compass spanner
 - + allen key 2.5 mm
 - + allen key 6 mm

STANDARD TOOLS	DYNAMOMETRIC WRENCH	MOBILE TEST BENCH
<p>CODE: HZ710001</p> <p>DESCRIPTION: Standard tools set for maintenance Cressi regulators</p>	<p>CODE: HZ709021</p> <p>DESCRIPTION: Dynamometric wrench + full set of accessories</p>	<p>CODE: HZ709030</p> <p>DESCRIPTION: Cressi regulator mobile test bench</p>

SINGLE TOOL

PIN SPANNER	ANTIFREEZE/S.C. SPANNER	HOOK SPANNER (AC2 EXTERNAL IP TOOL)	BIG COMPASS SPANNER	1ST STAGE IP SETTING GAUGE	THREADED BAR	O-RING REMOVAL TOOL	EXTRACTION POINT TOOL	SPRING PUSH TOOL	UNIVERSAL PUSH TOOL	GAUGE FOR 2ND STAGE	REMOVING HP SEAT AC2	24 X 14 IN (61 X 35.5 CM) NEOPRENE REPAIR MAT
-------------	-------------------------	-------------------------------------	---------------------	----------------------------	--------------	---------------------	-----------------------	------------------	---------------------	---------------------	----------------------	---

CODE	PRODUCT
HZ709002	SPANNER for ANTIFREEZE / SEAL CHAMBER
HZ709003	BIG COMPASS SPANNER for S.C.
HZ709004	EXTRACTION POINT TOOL for 1st STAGES
HZ709005	CIRCLIP PLIERS for 1st STAGES
HZ709006	ALLEN KEY 6mm
HZ709007	ALLEN KEY 4mm
HZ709008	THREADED BAR TO TIGHTEN THE 1st STAGE IN THE VICE
HZ709009	NUT DRIVER 5.5mm
HZ709010	JIG ADJUSTMENT for ELLIPSE 2nd STAGE
HZ709011	PUSH TOOL for 2nd STAGES
HZ709012	SOCKET WRENCH REMOVER TOOL
HZ709013	SMALL COMPASS SPANNER for 2nd STAGE
HZ709016	O-RING REMOVAL TOOL
HZ709017	EXTRACTION PLIER
HZ709018	YOKE REMOVING TOOL
HZ709019	REMOVING HP SEAT AC2
HZ710010	IP SETTING GAUGE for REGULATOR 1st STAGE
HZ710011	PRESSURE SETTING GAUGE for 2nd STAGE
HZ739001	UNIVERSAL PUSH TOOL
HZ739002	OGIVAL TOOL O-RING BULLIT for 1st STAGE
HZ739003	PIN SPANNER
HZ739051	HOOK SPANNER (AC2 EXTERNAL IP TOOL)
USV100000	NEOPRENE REPAIR MAT

HIGH LIFT CAPACITY | NYLON 420 D BACK CELL | FLAT LOCK AID WEIGHT SYSTEM

COMMANDER EVOLUTION

| BACK INFLATION | INTEGRATED WEIGHT POCKETS



» HIGH LIFT CAPACITY

TECHNICAL FEATURES

- **Air cell material:** 420 denier nylon
- Integrated Cressi Flat-lock Aid weight System
- 2 rear ballast pouches
- 3 pressure relief valves
- Four 50mm aluminium D-rings on the shoulder straps
- Four 25 mm stainless steel D-rings (2 on the pockets and 2 on the lower part of the harness)
- Ultralight rigid back plate with carrying handle.
- Next generation anatomical inflator with hose retainer
- Multipurpose zip pockets
- 50 mm quick-release buckled shoulder straps
- Multipurpose zip pockets

BUOYANCY

SIZE	NEWTON	KG	POUNDS
XS	130	13.3	29.2
S	130	13.3	29.2
M	190	19.4	42.7
L	220	22.4	49.5
XL	220	22.4	49.5

PRODUCT WEIGHT

SIZE	KG	LBS
XS	3.05	6.70
S	3.10	6.83
M	3.20	7.05
L	3.30	7.27
XL	3.40	7.50

The Commander Evolution Jacket is an impressively light high-buoyancy rear-mounted BC, anatomically designed for maximum comfort and wearability. Its main features are its detachable harness and air cell. The rear-mounted air cell interferes neither with the main underwater component nor the adjustment straps, not even when it is inflated to the maximum. This means extra freedom of movement and buoyancy for the diver. The special air cell compression strap guarantees extra quick deflation and volume control. The ultralight rigid back plate with its

integrated carrying handle ensures optimal stability. Its integrated Cressi Flat-Lock-Aid weight system makes it extra easy to release the pockets and rear ballast bags (attached to the tank-block band). Accessories include four 50mm shoulder aluminium D-rings and four 25mm aluminium D-rings (of which two on the pockets and two on the lower part of the harness). There are 3 pressure relief valves: one on the upper part of the hose, one reel-operated valve on the right-hand side of the shoulder and a third on the lower right-hand side of the air cell.

CODE	SIZE	CASE PACK
IC771000	XS	1
IC771001	S	1
IC771002	M	1
IC771003	L	1
IC771004	XL	1

OPTIONAL ACCESSORIES

CODE	PRODUCT
IZ750094	INTEGRATED FLAT-LOCK WEIGHT POCKET 10 LB
IC760099	TANK STRAP WEIGHT POCKET

SPARE PARTS

CODE	PRODUCT
IZ750275	O-RING MAINTENANCE KIT for BCD INFLATOR FLAT

| ADJUSTABLE CUMMERBUND



REAR ATTACHMENT HARNESS FOR MAXIMUM STABILITY



BLACK ALU D-RINGS



ZIPPED POCKETS



BACK WEIGHT POCKETS

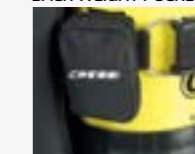

50 MM BUCKLES



FLAT LOCK SYSTEM



B.C.D.'S

SCUBA



37 WE
MANUFACTURE
QUALITY SINCE
1946

NYLON 420 D BACK CELL | FLAT LOCK AID WEIGHT SYSTEM

CARBON

| JACKET-STYLE | INTEGRATED WEIGHT POCKETS



The Carbon jacket is a classically built BCD. Its intermediate buoyancy level makes it extremely versatile and suitable in any situation. The ergonomic design of the inflator mechanism makes inflating and deflating extra easy and the practical

hose retainer keeps it compact and safe. Its special ultralight back plate maintains the tank body compact which significantly improves both underwater and surface buoyancy and comfort.

CODE	SIZE	CASE PACK
IC741300	XS	1
IC741301	S	1
IC741302	M	1
IC741303	L	1
IC741304	XL	1

OPTIONAL ACCESSORIES

CODE	PRODUCT
IZ750094	INTEGRATED FLAT-LOCK WEIGHT POCKET 10 LB
IC760099	TANK STRAP WEIGHT POCKET

SPARE PARTS

CODE	PRODUCT
IZ750275	O-RING MAINTENANCE KIT for BCD INFLATOR FLAT



TECHNICAL FEATURES

- 420 denier nylon air cell
- Ultralight, rigid back plate with carrying handle
- Next generation ergonomic inflator with hose retainer
- 2 multipurpose zip pockets
- Rear ballast pockets
- Shoulder straps with 50 mm quick-release buckles
- 3 pressure relief valves

BUOYANCY

SIZE	NEWTON	KG	POUNDS
XS	80	8.2	18.0
S	90	9.2	20.2
M	130	13.3	29.2
L	160	16.3	36.0
XL	190	19.4	42.7

PRODUCT WEIGHT

SIZE	KG	LBS
XS	3.00	6.61
S	3.10	6.83
M	3.20	7.05
L	3.30	7.27
XL	3.40	7.50



ANODISED LIGHT ALLOY BACK PLATE | NYLON 210 D AIR BLADDER | MODULAR ADJUSTMENT SYSTEM | EQUIPPED WITH WEIGHT POCKETS



AQUAWING PLUS NEW 2022

ONE SIZE FITS ALL + WEIGHT POCKETS

ANODISED LIGHT ALLOY BACK PLATE



WEIGHT POCKETS INCLUDED



MODULAR ADJUSTMENT SYSTEM

Aquawing Plus is the one-size donut jacket designed to adapt to all anatomies (male and female) using the new patented MAS (MAS (Modular Adjustment System): in fact, the single 50 mm belt that embraces the shoulders and waist can be rapidly adjusted to your size. The shape of the air bladder has been designed to ensure perfect buoyancy with a monocyliner. The anodised light alloy back plate reduces the overall weight of the jacket while guaranteeing stability and safety in use. The special cylinder rests in thermoplastic

rubber integrated with the back of the jacket guarantees the positioning of the tank for optimum trim. The shoulder straps and back cover are made with an air-net material to enhance comfort and improve water drainage. The jacket is equipped with two weight pockets attached directly to the back plate in correspondence with your flanks. The back cover is equipped with a special pocket designed to house the decompression buoy.

TECHNICAL FEATURES

- One-size-fits-all (XS / XL)
- **Air bladder:** 210 D nylon
- **Air bladder cover:** 1500 D cordura
- MAS (Modular Adjustment System)
- 5 Stainless steel D-ring

BUOYANCY

SIZE	NEWTON	KG	POUNDS
XS-XL	130	13.3	29.3

PRODUCT WEIGHT

SIZE	KG	LBS
XS-XL	2.90	6.39



PATENTED MODULAR ADJUSTMENT SYSTEM
The single belt that embraces the shoulders and waist can be rapidly adjusted

BACK WEIGHT POCKETS INCLUDED



CODE	SIZE	CASE PACK
IC79010	XS/XL	1

ACCESSORIES

CODE	PRODUCT
IZ790000	AQUAWING OPTIONAL D-RING
IC760099	TANK STRAP WEIGHT POCKET

SPARE PARTS

CODE	PRODUCT
IZ750275	O-RING MAINTENANCE KIT for BCD INFLATOR FLAT



AQUAWING NEW 2022

ONE SIZE FITS ALL

ANODISED LIGHT ALLOY BACK PLATE

MODULAR ADJUSTMENT SYSTEM



Aquawing is the one-size donut jacket designed to adapt to all anatomies (male and female) using the new patented MAS (MAS (Modular Adjustment System): in fact, the single 50 mm belt that embraces the shoulders and waist can be rapidly adjusted to your size. The shape of the air bladder has been designed to ensure perfect buoyancy with a monocyliner. The anodised light alloy back plate reduces the overall weight of

the jacket while guaranteeing stability and safety in use. The special cylinder rest in thermoplastic rubber integrated with the back of the jacket guarantees the positioning of the tank for optimum trim. The shoulder straps and back cover are made with an air-net material to enhance comfort and improve water drainage. The back cover is equipped with a special pocket designed to house the decompression buoy.

TECHNICAL FEATURES

- One-size-fits-all (XS / XL)
- **Air bladder:** 210 D nylon
- **Air bladder cover:** 1500 D cordura
- MAS (Modular Adjustment System)
- 4 Stainless steel D-ring + 1 optional

BUOYANCY

SIZE	NEWTON	KG	POUNDS
XS-XL	130	13.3	29.3

PRODUCT WEIGHT

SIZE	KG	LBS
XS-XL	2.90	6.39



PATENTED MODULAR ADJUSTMENT SYSTEM
The single belt that embraces the shoulders and waist can be rapidly adjusted

OPTIONAL D-RING



CODE	SIZE	CASE PACK
IC790000	XS/XL	1

ACCESSORIES

CODE	PRODUCT
IZ790000	AQUAWING OPTIONAL D-RING
IC760099	TANK STRAP WEIGHT POCKET

SPARE PARTS

CODE	PRODUCT
IZ750275	O-RING MAINTENANCE KIT for BCD INFLATOR FLAT

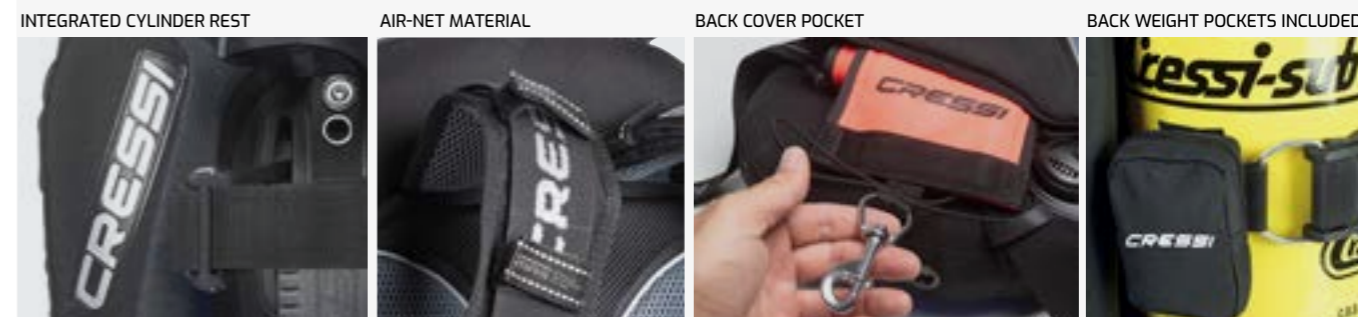

DESIGNED FOR FEMALE ANATOMY | FLAT LOCK AID WEIGHT SYSTEM

ELETTRA

NEW 2022

I SPECIFICALLY DESIGNED FOR WOMEN



TECHNICAL FEATURES

- Female anatomy
- (SIZES: XS-S-M-L)
- Air bladder: nylon 420 D
- Pockets and shoulder straps: cordura 1500 D
- Self Pivoting Waist Band
- Integrated Cressi Flat-Lock Aid weight System
- 2 zip up pockets for accessories
- Semi-rigid harness
- 6 D-rings in stainless steel
- 3 discharge and overpressure valves



The Eletttra jacket has been conceived to adapt to the female anatomy. The exclusive design and technical features provide perfect buoyancy with a close-fitting profile. The 40 mm buckles (shoulder-waist) adapt perfectly to the female anatomy. The lower band of the shoulder strap is anchored to a ring to ensure rotation and therefore maximum adaptability to the female anatomy. The internal part is fully lined with air-net material, with thicker padding to increase comfort and

improve water drainage. The two-piece waist band uses the new patented SPWB (Self Pivoting Waist Band) system.

The soft and padded semi-rigid back plate permits the BCD to be folded and transported with the minimum possible volume. The Cressi Flat Lock integrated ballast system makes the extraction of the weight bags particularly easy. The jacket's two integrated cylinder supports improve the diver's trim.

CODE	SIZE	CASE PACK
IC774001	XS	1
IC774002	S	1
IC774003	M	1
IC774004	L	1

ACCESSORIES

CODE	PRODUCT
I2750094	INTEGRATED FLAT-LOCK WEIGHT POCKET 10 LB
IC760099	TANK STRAP WEIGHT POCKET

SPARE PARTS

CODE	PRODUCT
I2750275	O-RING MAINTENANCE KIT for BCD INFLATOR FLAT

40MM BUCKLES

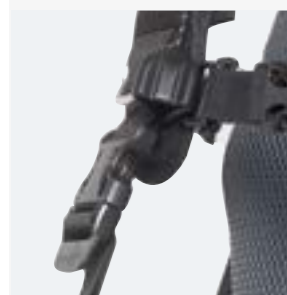

FULLY ADJUSTABLE WAIST HARNESS // SELF PIVOTING WAIST BAND



STEEL D-RINGS



ZIPPED POCKETS



FLAT LOCK SYSTEM

SPECIALIZED Retailer-Product

NYLON 420 D STANDARD CELL | FLAT LOCK AID WEIGHT SYSTEM

AVIATOR

I SEMI-RIGID PADDED BACK
I INTEGRATED WEIGHT POCKETS



The Aviator is a full vest inflation B.C.D. featuring many accessories and pockets for tools but made with a classic structure designed for travel. The new modular system of the abdominal band, with

exclusive Cressi design, offers the possibility to quickly change the band itself – divided into two parts – to adapt to different sizes.

CODE	SIZE	CASE PACK
IC772000	XS	1
IC772001	S	1
IC772002	M	1
IC772003	L	1
IC772004	XL	1

ACCESSORIES

CODE	PRODUCT
I2750094	INTEGRATED FLAT-LOCK WEIGHT POCKET 10 LB
IC760099	TANK STRAP WEIGHT POCKET



SPARE PARTS

CODE	PRODUCT
I2750275	O-RING MAINTENANCE KIT for BCD INFLATOR FLAT

ZIPPED POCKETS



LIGHT ALLOY D-RINGS



50 MM ROTATING BUCKLES



SELF PIVOTING WAIST BAND



FLAT LOCK SYSTEM

IDEAL FOR TRAVEL

SPECIALIZED Retailer-Product

MADE IN ITALY

TECHNICAL FEATURES

- 210 Denier nylon fabric
- New modular cummerbund system
- Integrated flat-lock weight pocket system
- 2 Zip-up wide side pockets
- 2 Rear ballast pockets
- Semi-rigid padded backplate
- D-rings in light alloy
- 3 Pressure relief valves: on top of the inflator, on top of right shoulder, on the bottom right of the air cell. All controlled by the front



BUOYANCY

SIZE	NEWTON	KG	POUNDS
XS	60	6.1	13.5
S	80	8.2	18.0
M	90	9.2	20.2
L	130	13.3	29.2
XL	160	16.3	36.0

PRODUCT WEIGHT

SIZE	KG	LBS
XS	2.40	5.29
S	2.40	5.29
M	2.50	5.51
L	2.50	5.51
XL	2.60	5.73

NYLON 420 D STANDARD CELL | FLAT LOCK AID WEIGHT SYSTEM

SPECIALIZED Retailer-Product | MADE IN ITALY

SCORPION

| BACK INFLATION | VERTICAL INTEGRATED WEIGHT POCKETS



TECHNICAL FEATURES

- Development of rear-mounted air cell
- Air cell fabric:** 420 denier nylon
- Integrated flat-lock weight pocket system
- In vertical position
- 3 pressure relief valves:** one on the upper part of the hose, one reel-operated valve on the right-hand side of the shoulder and a third on the lower right-hand side of the air cell
- Two 50 mm aluminium D-rings on the shoulder straps
- Two 25 mm aluminium D-rings on the pockets
- Ultralight semi-rigid harness
- Next generation anatomical inflator with hose retainer
- Multipurpose zip pockets
- 40 Mm quick-release buckles on shoulder straps
- Side adjustable lumbar flaps

BUOYANCY

SIZE	NEWTON	KG	POUNDS
XS	130	13.3	29.2
S	130	13.3	29.2
M	150	15.3	33.7
L	150	15.3	33.7
XL	150	15.3	33.7

The Scorpion jacket is an impressively light high-buoyancy rear-mounted BC, anatomically designed for maximum comfort and wearability. Its main features are its detachable harness and air cell. The rear-mounted air cell interferes neither with the main underwater component nor with the adjustment straps, not even when it is inflated to the maximum: this means extra freedom of

movement and buoyancy for the diver. The special air cell compression strap guarantees extra quick deflation and volume control. The ultralight semi-rigid harness ensures optimal stability and high comfort with its air-net fabric. Its integrated Cressi Flat-Lock-Aid Weight system makes it extra easy to release the pockets.

CODE	SIZE	CASE PACK
IC770000	XS	1
IC770001	S	1
IC770002	M	1
IC770003	L	1
IC770004	XL	1

ACCESSORIES

CODE	PRODUCT
I2750094	INTEGRATED FLAT-LOCK WEIGHT POCKET 10 LB
IC760099	TANK STRAP WEIGHT POCKET

SPARE PARTS

CODE	PRODUCT
I2750275	O-RING MAINTENANCE KIT for BCD INFLATOR FLAT



IDEAL FOR TRAVEL | SPECIALIZED Retailer-Product | MADE IN ITALY

LIGHTWING

| BACK INFLATION | INTEGRATED WEIGHT POCKETS



TECHNICAL FEATURES

- 420 Denier nylon fabric
- Integrated flat-lock weight pocket system
- Semi-rigid padded backplate
- Hideaway pocket on the right Adjustable shoulder and chest strap
- 3 Pressure relief valves:** on top of the inflator, on top of right shoulder, on the bottom right of the air cell. All controlled by the front

BUOYANCY

SIZE	NEWTON	KG	POUNDS
XS	90	9.2	20.2
S	90	9.2	20.2
M	90	9.2	20.2
L	150	15.3	33.7
XL	150	15.3	33.7

The Lightwing is a rear-mounted air cell B.C.D. with extremely low weight. Its 2 kg for size M makes it indispensable for travel. The semi-rigid, soft and padded backplate allows you to fold and carry the device in the smallest possible space, thanks also to a strap with Velcro for instant packaging.

The special air-net material is present in the shoulder straps and backrest to ensure greater

comfort and water drainage. Adjustable shoulder straps and chest strap. It features a hideaway pocket on the right for extra space for the accessories. The Flat-Lock Integrated Weight Aid System makes it very easy to remove the ballast from the sides.

Two supports, integrated on the back lower part for fixing the tank, improve the diver trim.



FAST FOLDING SYSTEM



FLAT LOCK SYSTEM

CODE	SIZE	CASE PACK
IC773000	XS	1
IC773001	S	1
IC773002	M	1
IC773003	L	1
IC773004	XL	1

ACCESSORIES

CODE	PRODUCT
I2750094	INTEGRATED FLAT-LOCK WEIGHT POCKET 10 LB
IC760099	TANK STRAP WEIGHT POCKET

SPARE PARTS

CODE	PRODUCT
I2750275	O-RING MAINTENANCE KIT for BCD INFLATOR FLAT



NYLON 420 D STANDARD CELL | FLAT LOCK AID WEIGHT SYSTEM

TRAVELIGHT™

| FLEXIBLE PADDED BACK | INTEGRATED WEIGHT POCKETS



TECHNICAL FEATURES

- 2 zip up pockets
- 2 rear weight carrying pockets
- Soft, padded back, with double strap for fixing the tank
- Three discharge and pressure valves
- Rear release valve with control brought to the front

BUOYANCY

SIZE	NEWTON	KG	POUNDS
XS	60	6.1	13.5
S	80	8.2	18.0
M	90	9.2	20.2
L	130	13.3	29.2
XL	160	16.3	36.0



2.50 kg - 5.5 lb
SIZE M



BLUE

PINK

The Travelight from Cressi is designed as a super-serious travel BCD: The basic design was drawn from the Cressi Flex BCD the first worldwide travel BCD in the Scuba Industry.

Dry weight of the Travelight is only 6 lb. (2.7 kg). The back is amply padded, for a comfortable fit. The BCD uses Cressi's Lock Aid integrated weight system,

and can store 20 lb (9 kg) in the front pockets and a further 10 lb (4.5 kg) in the no - detachable back pockets. With an eye on keeping the weight down, all of the D-rings are made from a lightweight material. The air cell inflates away from the body, which avoids constricting the diver. The Cressi Travelight has 13.5 lb of lift (6 kg) in its smallest size and 36 lb (16.3 kg) in its largest sizes.



PINK

CODE	SIZE	CASE PACK
IC740620	XS	1
IC740621	S	1
IC740622	M	1

BLUE

CODE	SIZE	CASE PACK
IC740600	XS	1
IC740601	S	1
IC740602	M	1
IC740603	L	1
IC740604	XL	1

BLUE



FLAT LOCK SYSTEM



ACCESSORIES

CODE	PRODUCT
IZ750094	INTEGRATED FLAT-LOCK WEIGHT POCKET 10 LB
IC760099	TANK STRAP WEIGHT POCKET

SPARE PARTS

CODE	PRODUCT
IZ750080	O-RING MAINTENANCE KIT for BCD INFLATOR

FAST FOLDING SYSTEM



LIGHT ALLOY D-RINGS // 40MM BUCKLES



ZIPPED POCKETS



NYLON 420 D STANDARD CELL | FLAT LOCK AID WEIGHT SYSTEM

AQUARIDE

// SEMI-CLASSIC STRUCTURED // INTEGRATED WEIGHT POCKETS



TECHNICAL FEATURES

- Adjustable shoulder straps
- Superlight rigid backpack with handle
- Next generation anatomical inflator with hose retainer
- Expandable sundries pocket with zip closure
- Quick-attach rear weight pockets (capacity 2 kg/5 pounds)
- 3 purge and overpressure valves of the air cell. All controlled by the front

BUOYANCY

SIZE	NEWTON	KG	POUNDS
XS	80	8.2	18.0
S	90	9.2	20.2
M	130	13.3	29.2
L	160	16.3	36.0
XL	190	19.4	42.7

BACK WEIGHTS POCKETS



50MM BUCKLES



STEEL D-RINGS



ZIPPED POCKETS



FLAT LOCK SYSTEM

The Aquaride is a semi-classic structured BC with a special feature: it has adjustable shoulder straps that aren't restricted by the air cell, improving the grip on the tank and improving comfort. Thanks to their anatomical, preformed profile, they are much easier to put on and make resting the tank more comfortable on the shoulders.

The BC features the Flat type Lock Aid System of integrated weight. It is very effective and comfortable thanks to its extremely flat profile and the easy and intuitive arrangement of the pockets. Finally, the anatomical control has a hose retainer,

making all inflation and deflation operations very easy and intuitive. Fully redesigned in 2015, the Aquaride Blue Pro offers the the best option for your dive experience.

The Aquaride has been considered the only BC in its test group to earn solid scores in all performances for two years. The Aquaride passed and placed first in all tests thanks to the size range, efficient adjustments, and its super-stability at depth. In the final countdown for Testers' Choice, it earned almost twice as many favourite points as its closest competitor.

CODE	SIZE	CASE PACK
IC740800	XS	1
IC740801	S	1
IC740802	M	1
IC740803	L	1
IC740804	XL	1

ACCESSORIES

CODE	PRODUCT
I2750094	INTEGRATED FLAT-LOCK WEIGHT POCKET 10 LB
IC760099	TANK STRAP WEIGHT POCKET

SPARE PARTS

CODE	PRODUCT
I2750080	O-RING MAINTENANCE KIT for BCD INFLATOR

ALSO FOR RENTAL

HIGH LIFT CAPACITY | CORDURA 500 D STANDARD CELL | FLAT LOCK AID WEIGHT SYSTEM

QUARTZ

| JACKET-STYLE | INTEGRATED WEIGHT POCKETS



TECHNICAL FEATURES

- Cordura 500 Denier fabric (exterior and interior part)
- Integrated Cressi Flat-Lock Aid weight System
- 2 large accessory holder zip-up pockets
- Light-weight, rigid backplate with carry handle
- 3 overpressure dump valves
- 225 mm technopolymer D-rings on the pockets
- Size shown on shoulder straps
- 50 mm shoulder straps with buckles

BUOYANCY

SIZE	NEWTON	KG	POUNDS
XS	120	12.2	27.0
S	140	14.3	31.5
M	160	16.3	36.0
L	190	19.4	42.7
XL	220	22.4	49.5

Quartz, which has good buoyancy, is the ideal B.C.D. for scuba diving schools and equipment rental centers. The Integrated Cressi Flat-Lock Aid weight System makes it very easy to remove

the lead pockets. It features a colored reinforcement band in the upper part of the back, at neck level, to enhance visibility in the water and protect the jacket from the abrasive action of the first stage.

CODE	SIZE	CASE PACK
JIC741900	XS	1
JIC741901	S	1
JIC741902	M	1
JIC741903	L	1
JIC741904	XL	1

ACCESSORIES

CODE	PRODUCT
I2750094	INTEGRATED FLAT-LOCK WEIGHT POCKET 10 LB
IC760099	TANK STRAP WEIGHT POCKET

SPARE PARTS

CODE	PRODUCT
I2750275	O-RING MAINTENANCE KIT for BCD INFLATOR FLAT

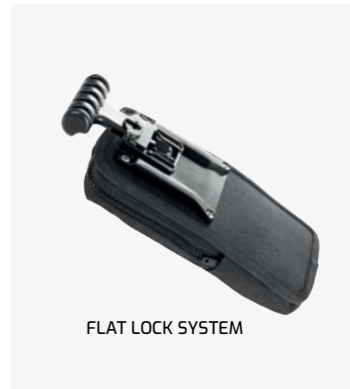

FLAT LOCK SYSTEM

HIGH VISIBILITY BACK PAD



50MM BUCKLES



ZIPPED POCKETS



ULTRA RESISTANT MATERIALS



NYLON 420 D STANDARD CELL | FLAT LOCK AID WEIGHT SYSTEM

PATROL

| BACK INFLATION | INTEGRATED WEIGHT POCKETS



The Patrol BC is an impressively lightweight, rear inflation BC that is anatomically designed for maximum comfort and durability. The special air cell compression strap guarantees extra quick deflation and volume control. The ultralight rigid back plate with its integrated carrying handle ensures optimal stability. The Patrol also features Cressi's Flat-Lock-Aid integrated weight system that makes it easy to

release the pockets. There are 3 pressure relief valves: one on the upper part of the hose, one valve on the right-hand side of the shoulder and a third on the lower right-hand side of the air cell. The Patrol also features plastic D-rings to help reduce weight and the shoulder and the waist harness is fully adjustable to one full size up or down from the stated size.

CODE	SIZE	CASE PACK
IC741600	XS	1
IC741601	S	1
IC741602	M	1
IC741603	L	1
IC741604	XL	1

ACCESSORIES

CODE	PRODUCT
IZ750094	INTEGRATED FLAT-LOCK WEIGHT POCKET 10 LB
IC760099	TANK STRAP WEIGHT POCKET

SPARE PARTS

CODE	PRODUCT
IZ750275	O-RING MAINTENANCE KIT for BCD INFLATOR FLAT



40MM BUCKLES

FULLY ADJUSTABLE SHOULDER HARNESS

HIDEAWAY POCKET

FULLY ADJUSTABLE WAIST HARNESS

FLAT LOCK SYSTEM



TECHNICAL FEATURES

- Back inflation bcd
- Ultralight rigid back plate
- Soft, padded back

BUOYANCY

SIZE	NEWTON	KG	POUNDS
XS	130	13.3	29.2
S	130	13.3	29.2
M	190	19.4	42.7
L	220	22.4	49.5
XL	200	22.4	49.5



BACK WEIGHT POCKETS OPTIONAL



BACK VIEW



FLAT LOCK SYSTEM

HIGH LIFT CAPACITY | CORDURA 500 D STANDARD CELL | FIXED GRAVITY POCKETS

START PRO 2.0

| JACKET-STYLE | GRAVITY WEIGHT POCKETS



Designed primarily as a rental BC for resorts and dive schools, the Start Pro gives students and customers the stability of a jacket style BC and the convenience of weight integration.

Dive operators will appreciate its bullet-proof construction using 1000 and 500 Denier Nylon Cordura® and large, easily seen size markings on the shoulder.

TECHNICAL FEATURES

- Ultra durable construction
- Integrated weight pockets use rugged quick-release buckles
- 2 Large pockets cargo pockets with ykk zipper closure
- Rigid padded backpack and carry handle
- Three exhaust valves for buoyancy adjustment in any position
- 250mm technopolymer d-rings available in the shoulder straps
- 4 available d-rings: 1 above, 1 at the bottom of each pocket
- Size clearly visible on the shoulder strap Cordura 500 Denier fabric (exterior and interior part)
- Integrated Cressi Flat-Lock Aid weight System
- 2 large accessory holder zip-up pockets
- Light-weight, rigid backplate with carry handle
- 3 overpressure dump valves
- 225 mm technopolymer D-rings on the pockets
- Size shown on shoulder straps
- 50 mm shoulder straps with buckles

BUOYANCY

SIZE	NEWTON	KG	POUNDS
XXS	70	7.14	15.7
XS	130	13.3	29.2
S	140	14.3	31.5
M	150	15.3	33.7
L	170	17.3	38.2
XL	200	20.4	45.0
XXL			

CODE	SIZE	CASE PACK
NEW IC721905	2XS	1
IC721900	XS	1
IC721901	S	1
IC721902	M	1
IC721903	L	1
IC721904	XL	1
NEW IC721906	2XL	1

ACCESSORIES

CODE	PRODUCT
IZ750094	INTEGRATED FLAT-LOCK WEIGHT POCKET 10 LB
IC760099	TANK STRAP WEIGHT POCKET

SPARE PARTS

CODE	PRODUCT
IZ750275	O-RING MAINTENANCE KIT for BCD INFLATOR FLAT



FIXED GRAVITY POCKET SYSTEM

GAUGE AND OCTOPUS HOLDER

ENGINEERED PLASTIC D-RINGS // 50 MM BUCKLES

ZIPPED POCKETS



BACK VIEW

HIGH LIFT CAPACITY | CORDURA 500 D STANDARD CELL

SOLID

NEW 2XL SIZE

| JACKET-STYLE | 500D/420D NYLON



TECHNICAL FEATURES

- **Exterior:** Cordura 500D nylon
- **Interior:** Cordura 420D nylon
- 2 large accessory holder zip-up pockets
- Light-weight, rigid backplate with carry handle
- 3 overpressure dump valves
- 232 mm technopolymer O-rings on the pockets
- Size clearly visible on the shoulder strap
- 50 Mm shoulder straps with buckles

BUOYANCY

SIZE	NEWTON	KG	POUNDS
XXS	80	8.2	18.0
XS	120	12.2	27.0
S	140	14.3	31.5
M	160	16.3	36.0
L	190	19.4	42.7
XL	220	22.4	49.5
XXL			

Jacket Solid: good buoyancy, ideal for scuba diving schools and equipment rental centers. It features a colored reinforcement band in the upper part of the back, at neck level, to

enhance visibility in the water and protect the jacket from the abrasive action of the first stage. The sternal attachment is closed by a buckle which also serves as a safety whistle.



GAUGE AND OCTOPUS HOLDER



CODE	SIZE	CASE PACK
JIC741705	2XS	1
JIC741700	XS	1
JIC741701	S	1
JIC741702	M	1
JIC741703	L	1
JIC741704	XL	1
JIC741706	2XL	1

ACCESSORIES

CODE	PRODUCT
IC760099	TANK STRAP WEIGHT POCKET

SPARE PARTS

CODE	PRODUCT
I2750275	O-RING MAINTENANCE KIT for BCD INFLATOR FLAT

HIGH VISIBILITY BACK PAD



50MM BUCKLES



ZIPPED POCKETS



ULTRA RESISTANT MATERIALS



HIGH LIFT CAPACITY | CORDURA 500 D STANDARD CELL

ALSO FOR RENTAL

START

| JACKET-STYLE | 1000D/500D NYLON



TECHNICAL FEATURES

- Ultra durable construction
- Ideal for frequently use
- 2 Large pockets cargo pockets with velcro closure
- Rigid padded backpack and carry handle
- Three exhaust valves for buoyancy
- Adjustment in any position
- 4 Available D-rings: 1 above, 1 at the bottom of each pocket
- Size clearly visible on the shoulder strap

BUOYANCY

SIZE	NEWTON	KG	POUNDS
XS	130	13.3	29.2
S	140	14.3	31.5
M	150	15.3	33.7
L	170	17.3	38.2
XL	200	20.4	45.0

Designed primarily as a rental BCD for resorts and dive schools, the Start is a simple, functional jacket-style BCD without weight integration. Diver operators will appreciate its

bullet-proof construction using Cordura 1000 and 500 Denier Nylon fabric and large, easily seen size markings on the shoulder.

CODE	SIZE	CASE PACK
IC721700	XS	1
IC721701	S	1
IC721702	M	1
IC721703	L	1
IC721704	XL	1

ACCESSORIES

CODE	PRODUCT
IC760099	TANK STRAP WEIGHT POCKET

SPARE PARTS

CODE	PRODUCT
I2750275	O-RING MAINTENANCE KIT for BCD INFLATOR FLAT

GAUGE AND OCTOPUS HOLDER



SIZE ON SHOULDER PAD



COMPACT TANK BACKPACK



B.C.D.'S

SIZE CHART



	ELETRA	AQUAWING	AQUAWING PLUS	COMMANDER EVOLUTION	CARBON	AVIATOR	LIGHTWING	AQUARIDE	SCORPION	TRAVELIGHT MAN - WOMAN	QUARTZ	PATROL	START PRO 2.0	SOLID	START
TYPE OF AIR CELL	Standard	Back cell	Back cell	Back cell	Back cell	Standard	Back cell	Standard	Back cell	Standard	Standard	Back cell	Standard	Standard	Standard
MATERIAL	Nylon 420 Denier	Nylon 210 Denari	Nylon 210 Denari	Nylon 420 Denier	Nylon 420 Denier	Cordura 210 Denier	Cordura 210 Denier	Cordura 420 Denier	Cordura 210 Denier	Cordura 210 Denier	Cordura 500 Denier	Cordura 420 Denier	Cordura 500 Denier	Cordura 500 Denier	Cordura 500 Denier
BUOYANCY (NEWTON - KG - LB)															
XXS	-	-	-	-	-	-	-	-	-	-	-	-	-	-	70 71 - 15.7
XS	n/a	130	130	130 13.3 - 29.2	80 8.2 - 18.0	60 6.1 - 13.5	90 9.2 - 20.2	80 8.2 - 18.0	130 13.3 - 29.2	60 6.1 - 13.5	120 12.2 - 27.0	130 13.3 - 29.2	130 13.3 - 29.2	80 8.2 - 18.0	130 13.3 - 29.2
S	n/a	130	130	130 13.3 - 29.2	90 9.2 - 20.2	80 8.2 - 18.0	90 9.2 - 20.2	90 9.2 - 20.2	130 13.3 - 29.2	80 8.2 - 18.0	140 14.3 - 31.5	130 13.3 - 29.2	140 14.3 - 31.5	120 12.2 - 27.0	140 14.3 - 31.5
M	150	130	130	190 19.4 - 42.7	130 13.3 - 29.2	90 9.2 - 20.2	90 9.2 - 20.2	130 13.3 - 29.2	150 15.3 - 33.7	90 9.2 - 20.2	160 16.3 - 36.0	190 19.4 - 42.7	150 15.3 - 33.7	160 16.3 - 36.0	150 15.3 - 33.7
L	n/a	130	130	225 22.9 - 50.6	160 16.3 - 36.0	130 13.3 - 29.2	150 15.3 - 33.7	160 16.3 - 36.0	150 15.3 - 33.7	130 13.3 - 29.2	190 19.4 - 42.7	225 22.9 - 50.6	170 17.3 - 38.2	160 16.3 - 36.0	170 17.3 - 38.2
XL	-	130	130	225 22.9 - 50.6	190 19.4 - 42.7	160 16.3 - 36.0	150 15.3 - 33.7	190 19.4 - 42.7	150 15.3 - 33.7	160 16.3 - 36.0	220 22.4 - 49.5	225 22.9 - 50.6	200 20.4 - 45.0	190 19.4 - 42.7	200 20.4 - 45.0
Type of Backplate	Soft	Rigid	Rigid	Rigid	Rigid	Soft	Soft	Rigid	Soft	Soft	Rigid	Rigid	Rigid	Rigid	Rigid
Cylinder fixing	Double strap	Double strap	Double strap	Single Strap	Single Strap	Double strap	Double strap	Single Strap	Double strap	Double Strap	Single Strap	Single Strap	Single Strap	Single Strap	Single Strap
Compatible cylinders															
Internal volume (liters)	10-12-15-18	10/12/15/18	10-12-15-18	10 - 12 - 15 - 18	10 - 12 - 15 - 18	10 - 12 - 15 - 18	10 - 12 - 15 - 18	10 - 12 - 15 - 18	10 - 12 - 15 - 18	10 - 12 - 15 - 18	10 - 12 - 15 - 18	10 - 12 - 15 - 18	10 - 12 - 15 - 18	10 - 12 - 15 - 18	10 - 12 - 15 - 18
Internal volume (cu. ft.)				0.35 - 0.42 - 0.53 - 0.63	0.35 - 0.42 - 0.53 - 0.63	0.35 - 0.42 - 0.53 - 0.63	0.35 - 0.42 - 0.53 - 0.63	0.35 - 0.42 - 0.53 - 0.63	0.35 - 0.42 - 0.53 - 0.63	0.35 - 0.42 - 0.53 - 0.63	0.35 - 0.42 - 0.53 - 0.63	0.35 - 0.42 - 0.53 - 0.63	0.35 - 0.42 - 0.53 - 0.63	0.35 - 0.42 - 0.53 - 0.63	0.35 - 0.42 - 0.53 - 0.63
Cylinder diameter (mm)	171/203/216	171/203/216	171/203/216	171/203/216	171/203/216	171/203/216	171/203/216	171/203/216	171/203/216	171/203/216	171/203/216	171/203/216	171/203/216	171/203/216	171/203/216
Cylinder diameter (in)				6.73/8.0/8.5	6.73/8.0/8.5	6.73/8.0/8.5	6.73/8.0/8.5	6.73/8.0/8.5	6.73/8.0/8.5	6.73/8.0/8.5	6.73/8.0/8.5	6.73/8.0/8.5	6.73/8.0/8.5	6.73/8.0/8.5	6.73/8.0/8.5
Weight pocket	Flat lock aid	No	Fixed pocket	Integrated Flat Lock System + 2 Tank Weight Pockets	Integrated Flat Lock System + 2 back pockets	Integrated Flat Lock System + 2 back pockets	Integrated Flat Lock System	Integrated Flat Lock System	Vertical Integrated Flat Lock System	Integrated Flat Lock System + 2 back pockets	Integrated Flat Lock System	Integrated Flat Lock System	Fixed Gravity Pocket	No	No
Max for pocket (kg)	4.5+4.5	No	3+3	4.5 + 4.5 + 4.5 + 4.5	4.5 + 4.5 + 3.5 + 3.5	4.5 + 4.5 + 3.5 + 3.5	4.5 + 4.5	4.5 + 4.5	4.5 + 4.5	4.5 + 4.5 + 3.5 + 3.5	4.5 + 4.5	4.5 + 4.5	2+2 (XXS, XS, S) 3+3 (M, L, XL)	No	No
Max for pocket (lb)				9.9 + 9.9 + 9.9 + 9.9	9.9 + 9.9 + 7.7 + 7.7	9.9 + 9.9 + 7.7 + 7.7	9.9 + 9.9	9.9 + 9.9	9.9 + 9.9	9.9 + 9.9 + 7.7 + 7.7	9.9 + 9.9	9.9 + 9.9	4.41 + 4.41 (XXS, XS, S) 6.61 + 6.61 (M, L, XL)		
Abdominal adjustment	Buckle+sp-wb (self pivoting waistband)	Buckle	Buckle	Adjustable Waist Band + Buckle	Standard Waist Band + Buckle	Reverse Buckle	Reverse Buckle	Standard Waist Band + Buckle	Reverse Buckle	Standard Waist Band + Buckle	Standard Waist Band + Buckle	Buckle + LAS (Length Adj. System)	Standard Waist Band + Buckle	Standard Waist Band + Buckle	Standard Waist Band + Buckle
Sternal Adjustment	Movable	No	No	Movable	Fixed	Fixed	Movable	Fixed	Movable	Fixed	Fixed	Movable	Fixed	Fixed	Fixed
Shoulder Strap Adjustment	Standard	Mas (Modular Adjustment System)	Mas (Modular Adjustment System)	Standard	Standard	Standard	Standard	Standard	Standard	Standard	Standard	Standard + LAS (Length Adj. System)	Standard	Standard	Standard
QUICK DUMP AND OVER-PRESSURE VALVES															
N°	2	1	1	2	2	2	2	2	2	2	2	2	2	2	2
Discharge Knob Position	At the front, lower right area - At the front, upper right Area	At the back, lower left area	At the back, lower left area	At the back, lower right area At the front, 2/3 upper right Area	At the back, lower right area At the front, 2/3 upper right Area	At the back, lower right area At the front, 2/3 upper right Area	At the back, lower right area At the front, 2/3 upper right Area	At the back, lower right area At the front, 2/3 upper right Area	At the back, lower right area At the front, 2/3 upper right Area	At the back, lower right area At the front, 2/3 upper right Area	At the back, lower right area At the front, 2/3 upper right Area	At the back, lower right area At the front, 2/3 upper right Area	At the back, lower right area At the front, 2/3 upper right Area	At the back, lower right area At the front, 2/3 upper right Area	At the back, lower right area At the front, 2/3 upper right Area
Total Dump Valves	4	3	3	4	4	4	4	4	4	4	4	4	4	4	4
N° Charge Valves	2	2	2	2	2	2	2	2	2	2	2	2	2	2	2
Type of Control Unit	Flat	Flat	Flat	Flat	Flat	Flat	Flat	Flat	Flat	Flat	Flat	Flat	Flat	Flat	Flat
POCKETS AND D-RINGS															
N° of Pockets	2	No	No	2	2	2	1	2	2	2	2	1	2	2	2
N° of Back Pockets	No	2	2	2	2	2	2	2	2	2	2	2	2	2	2
N° of D° Rings	6	4	5	8	8	6	4	8	6	6	4	6	6	4	4
B.C.D. WEIGHT TOTAL BALLAST THAT CAN BE USED (kg - lb)															
XXS	-	-	-	-	-	-	-	-	-	-	-	-	-	-	2.4 - 4 5.29 - 8.82
XS	3.15 - 9	3.34 - 6	2.90 - 6	3.05 - 14 6.72 - 30.86	3.0 - 14 6.61 - 30.86	2.4 - 14 5.29 - 30.86	1.9 - 9 4.20 - 19.84	3.0 - 14 6.72 - 30.86	2.4 - 11 5.29 - 24.25	2.4 - 14 5.29 - 30.86	2.4 - 14 5.29 - 30.86	2.6 - 9 5.73 - 19.84	2.5 - 4 5.51 - 8.82	2.4 - No 5.29 - No	2.4 - No 5.29 - No
S	3.15 - 9	3.34 - 6	2.90 - 6	3.1 - 14 6.83 - 30.86	3.1 - 14 6.83 - 30.86	2.4 - 14 5.29 - 30.86	1.95 - 9 4.30 - 19.84	3.1 - 14 6.83 - 30.86	2.45 - 11 5.51 - 24.25	2.4 - 14 5.29 - 30.86	2.5 - 14 5.51 - 30.86	2.6 - 9 5.73 - 19.84	2.6 - 4 5.73 - 8.82	2.5 - No 5.51 - No	2.5 - No 5.51 - No
M	3.15 - 9	3.34 - 6	2.90 - 6	3.2 - 14 7.05 - 30.86	3.2 - 14 7.05 - 30.86	2.5 - 14 5.51 - 30.86	2.0 - 9 4.41 - 19.84	3.2 - 14 7.05 - 30.86	2.5 - 13 5.73 - 28.66	2.5 - 14 5.51 - 30.86	2.6 - 14 5.73 - 30.86	2.75 - 9 6.06 - 19.84	2.75 - 6 6.06 - 13.23	2.6 - No 5.73 - No	2.6 - No 5.73 - No
L	3.15 - 9	3.34 - 6	2.90 - 6	3.3 - 14 7.27 - 30.86	3.3 - 14 7.27 - 30.86	2.5 - 14 5.51 - 30.86	2.05 - 9 4.52 - 19.84	3.3 - 14 7.27 - 30.86	2.6 - 13 5.51 - 28.66	2.5 - 14 5.51 - 30.86	2.7 - 14 5.95 - 30.86	2.9 - 9 6.39 - 19.84	2.8 - 6 6.18 - 13.23	2.7 - No 5.95 - No	2.7 - No 5.95 - No
XL	-	3.34 - 6	2.90 - 6	3.4 - 14 7.49 - 30.86	3.4 - 14 7.49 - 30.86	2.6 - 14 5.73 - 30.86	2.15 - 9 4.74 - 19.84	3.4 - 14 7.50 - 30.86	2.65 - 13 5.86 - 28.66	2.6 - 14 5.73 - 30.86	2.8 - 14 6.18 - 30.86	2.9 - 9 6.39 - 19.84	2.9 - 6 6.39 - 13.23	2.8 - No 6.18 - No	2.8 - No 6.18 - No

	COMMANDER EVOLUTION	CARBON	AVIATOR	LIGHTWING	SCORPION	AQUARIDE	TRAVELIGHT MAN - WOMAN	PATROL	START PRO 2.0	START	QUARTZ	SOLID
WEARABILITY												
XXS	CHEST (cm - in)											
	WAIST (cm - in)											
	OVER THE SHOULDER (cm - in)											
XS	CHEST (cm - in)	80/90 31.5/35.5	80/90 31.5/35.5	80/90 31.5/35.5	80/90 31.5/35.5	80/90 31.5/35.5	80/90 31.5/35.5	80/90 31.5/35.5	80/90 31.5/35.5	80/90 31.5/35.5	80/90 31.5/35.5	80/90 31.5/35.5
	WAIST (cm - in)	75/90 29/35	75/90 29/35	75/90 29/35	75/90 29/35	75/90 29/35	75/90 29/35	75/90 29/35	75/90 29/35	75/90 29/35	75/90 29/35	75/90 29/35
	OVER THE SHOULDER (cm - in)	81/94 32/37	81/94 32/37	81/94 32/37	81/94 32/37	81/94 32/37	81/94 32/37	81/94 32/37	78/105 37.5/41.5	81/94 32/37	81/94 32/37	81/94 32/37
S	CHEST (cm - in)	90/100 35.5/39.5	90/100 35.5/39.5	90/100 35.5/39.5	90/100 35.5/39.5	90/100 35.5/39.5	90/100 35.5/39.5	90/100 35.5/39.5	90/100 35.5/39.5	90/100 35.5/39.5	90/100 35.5/39.5	90/100 35.5/39.5
	WAIST (cm - in)	85/95 33.5/37.5	85/95 33.5/37.5	85/95 33.5/37.5	85/95 33.5/37.5	85/95 33.5/37.5	85/95 33.5/37.5	85/95 33.5/37.5	85/95 33.5/37.5	85/95 33.5/37.5	85/95 33.5/37.5	85/95 33.5/37.5
	OVER THE SHOULDER (cm - in)	83/96 32.5/38	83/96 32.5/38	83/96 32.5/38	83/96 32.5/38	83/96 32.5/38	83/96 32.5/38	83/96 32.5/38	78/105 37.5/41.5	83/96 32.5/38	83/96 32.5/38	83/96 32.5/38
M	CHEST (cm - in)	100/110 39.5/43.5	100/110 39.5/43.5	100/110 39.5/43.5	100/110 39.5/43.5	100/110 39.5/43.5	100/110 39.5/43.5	100/110 39.5/43.5	100/110 39.5/43.5	100/110 39.5/43.5	100/110 39.5/43.5	100/110 39.5/43.5
	WAIST (cm - in)	95/105 37.5/41	95/105 37.5/41	95/105 37.5/41	95/105 37.5/41	95/105 37.5/41	95/105 37.5/41	95/105 37.5/41	95/105 37.5/41	95/105 37.5/41	95/105 37.5/41	95/105 37.5/41
	OVER THE SHOULDER (cm - in)	85/106 33.5/41.5	85/106 33.5/41.5	85/106 33.5/41.5	85/106 33.5/41.5	85/106 33.5/41.5	85/106 33.5/41.5	85/106 33.5/41.5	82/120 32.5/47	85/106 33.5/41.5	85/106 33.5/41.5	85/106 33.5/41.5
L	CHEST (cm - in)	105/115 41.5/45	105/115 41.5/45	105/115 41.5/45	105/115 41.5/45	105/115 41.5/45	105/115 41.5/45	105/115 41.5/45	105/115 41.5/45	105/115 41.5/45	105/115 41.5/45	105/115 41.5/45
	WAIST (cm - in)	100/110 39.5/43.5	100/110 39.5/43.5	100/110 39.5/43.5	100/110 39.5/43.5	100/110 39.5/43.5	100/110 39.5/43.5	100/110 39.5/43.5	100/110 39.5/43.5	100/110 39.5/43.5	100/110 39.5/43.5	100/110 39.5/43.5
	OVER THE SHOULDER (cm - in)	86/110 34/43.5	86/110 34/43.5	86/110 34/43.5	86/110 34/43.5	86/110 34/43.5	86/110 34/43.5	86/110 34/43.5	82/120 32.5/47	86/110 34/43.5	86/110 34/43.5	86/110 34/43.5
XL	CHEST (cm - in)	115/125 45.5/49	115/125 45.5/49	115/125 45.5/49	115/125 45.5/49	115/125 45.5/49	115/125 45.5/49	115/125 45.5/49	115/125 45.5/49	115/125 45.5/49	115/125 45.5/49	115/125 45.5/49
	WAIST (cm - in)	110/120 39.5/47	110/120 39.5/47	110/								

START-ER PRO PACKAGE

START-ER PRO

DEALER PRICE

\$479.95 USD*

*ORIGINAL PRICE \$561.43 USD

MAP PRICE

\$799.95 USD*

*ORIGINAL PRICE \$894.80 USD

CODE	SIZE
IV722100	2XS
IV722101	XS
IV722102	S
IV722103	M
IV722104	L
IV722105	XL
IV722106	2XL



QUARTZ ESSENCE PACKAGE

DIVE LOCAL

DEALER PRICE

\$649.95 USD*

*ORIGINAL PRICE \$746.53 USD

MAP PRICE

\$1,099.95 USD*

*ORIGINAL PRICE \$1,295.80 USD

CODE	SIZE
IV741901	XS
IV741902	S
IV741903	M
IV741904	L
IV741905	XL



ITEMS INCLUDED

- B.C.D. QUARTZ
- REGULATOR MC9/COMPACT
- OCTOPUS COMPACT
- DIVE COMPUTER+ PRESSURE GAUGE
- DONATELLO CONSOLE 2

*This offer cannot be used in conjunction with any other promotion or offer | We reserve the right to discontinue or alter the terms of these offers at any time | No product substitution | Minimum Quantity 2 Packages

PACKAGES

SCUBA





QUARTZ ESSENCE COLD PACKAGE

COLD WATER

DEALER PRICE

\$699.95 USD*

*ORIGINAL PRICE \$781.70 USD

MAP PRICE

\$1,199.95 USD*

*ORIGINAL PRICE \$1,389.80 USD



CODE	SIZE
IY741911	XS
IY741912	S
IY741913	M
IY741914	L
IY741915	XL

ITEMS INCLUDED

B.C.D. QUARTZ
REGULATOR MC9-SC/COMPACT PRO
OCTOPUS COMPACT PRO
PRESSURE GAUGE + DEPTH GAUGE
DONATELLO CONSOLE 2

TRAVEL PATROL PACKAGE

TRAVEL PATROL

DEALER PRICE

\$719.95 USD*

*ORIGINAL PRICE \$877.32 USD

MAP PRICE

\$1,199.95 USD*

*ORIGINAL PRICE \$1,559.75 USD



CODE	SIZE
IY741601	XS
IY741602	S
IY741603	M
IY741604	L
IY741605	XL

ITEMS INCLUDED

B.C.D. PATROL
REGULATOR MC9/COMPACT
OCTOPUS COMPACT
DIVE COMPUTER+ PRESSURE GAUGE
DONATELLO CONSOLE 2
CARRY-ON BAG PIPER

*This offer cannot be used in conjunction with any other promotion or offer | We reserve the right to discontinue or alter the terms of these offers at any time | No product substitution | Minimum Quantity 2 Packages

BCD POCKETS & ACCESSORIES

FLAT-LOCK AID SYSTEM WEIGHT POCKET 10LB

DESCRIPTION:
Flat Lock Aid System weight pocket for Cressi Jacket

SUITABLE FOR:
Check compatibility at B.C.D.'s comparison table



CODE
IZ750094

TANK STRAP WEIGHT POCKET

DESCRIPTION:
Cam Band Trim / Tank Strap Back Weight Pocket

SUITABLE FOR:
COMMANDER EVOLUTION - LIGHTWING - PATROL



CODE
IC760099

HOSE CLIP FOR BCD

The Hose Clip is the quick solution for holding the Octopus hose retained to your scuba BCD. It can retain also gauges hoses. It features a double attachment for making a loop with the hose, but that can be easily released in case of an emergency. Thanks to the clip you can attach it to any D-Ring of your scuba BCD.



CODE
IZ750012

MULTIPURPOSE HANGER

The multi purpose hanger is water resistant and semi flexible. It allows users to safely place various types of scuba diving equipment, such as regulators, octopus and hoses, vests and/or suits in any environment instead of keeping it in a damp bag or tub. The hanger allows scuba material to drain and dry effectively while saving space.



CODE CASE PACK
TA700001 10

LIBRA

| BALLAST WEIGHT BAG

The Libra is the bag for carrying the ballast needed for your scuba diving equipment. It can carry also the weights used by the freedivers. It is made in strong and resistant Denier fabric, for long-lasting use and for a huge weight. Built rugged, the double webbing encircles the entire bag for added strength and joins to form a padded handle. Double-slider zipper makes it easy to access the main compartment. Personal tag or business card compartment on one side.



TECHNICAL FEATURES

- Capacity: 14 liters, 0.5 cu ft
- Dimension: 30.5 x 30.5 x 15.2 cm, 12 x 12 x 6 in



CODE	PRODUCT	CASE PACK
UB500550	LIBRA BALLAST WEIGHT BAG - BLACK	3

NYLON WEIGHT BELT

These are single-lined, thin, high stretch neoprene socks. The inner is lined in Metallite so they are easy to put on. The sole has an effective non-slip lining. They can be used with both closed foot fins for greater warmth and to protect the skin from scratches and chafing, as well as with firm-soled socks, using open-heel fins. In this case, warmth is considerably increased and it is also easier to put on your wetsuit.



METAL STAINLESS STEEL BUCKLE

HARD PLASTIC BUCKLE

CODE	PRODUCTS	CASE PACK
UW100000	METAL BUCKLE - BLACK	10
UW100001	METAL BUCKLE - NEON YELLOW	10
TA627020	HARD PLASTIC BUCKLE - BLUE	10

AVIATOR WAIST BAND

DESCRIPTION:
Interchangeable abdominal bands with Cressi self-pivoting system for Aviator B.C.D. jacket



CODE	PRODUCT
I2750140	AVIATOR WAIST BAND STANDARD
I2750146	AVIATOR WAIST BAND EXTENDED +5/10cm
I2750147	AVIATOR WAIST BAND EXTENDED +10/20 cm

SPARE PARTS CATALOGUE AVAILABLE

CUMMERBUND TYPE A



CUMMERBUND TYPE B



CUMMERBUND TYPE C



CODE	PRODUCT
I27501200	CUMMERBUND TYPE A (XS) for S2011T / BACK JAC
I27501201	CUMMERBUND TYPE A (S) for S2011T / BACK JAC
I27501202	CUMMERBUND TYPE A (M) for S2011T / BACK JAC
I27501203	CUMMERBUND TYPE A (L) for S2011T / BACK JAC
I27501204	CUMMERBUND TYPE A (XL) for S2011T / BACK JAC
I27501210	CUMMERBUND TYPE B (XS)
I27501211	CUMMERBUND TYPE B (S)
I27501212	CUMMERBUND TYPE B (M)
I27501213	CUMMERBUND TYPE B (L)
I27501214	CUMMERBUND TYPE B (XL)
I27501215	CUMMERBUND TYPE B (2XL)
I27501220	CUMMERBUND TYPE C (XS) for TRAVELIGHT
I27501221	CUMMERBUND TYPE C (S) for TRAVELIGHT
I27501222	CUMMERBUND TYPE C (M) for TRAVELIGHT
I27501223	CUMMERBUND TYPE C (L) for TRAVELIGHT
I27501224	CUMMERBUND TYPE C (XL) for TRAVELIGHT
I27501225	CUMMERBUND TYPE C (2XL) for TRAVELIGHT

*This offer cannot be used in conjunction with any other promotion or offer | We reserve the right to discontinue or alter the terms of these offers at any time | No product substitution | Minimum Quantity 2 Packages

B.C.D.'S

TOOLS



SQUARE DRIVER

SCHRADER VALVE TOOL

SOCKET WRENCH 12mm

COMPASS SPANNER

ALLEN KEY 2.5 mm

CODE	PRODUCT
I2750102	SQUARE DRIVER for BCD INFLATOR
I2750103	SCHRADER VALVE TOOL
I2760101	SOCKET WRENCH 12mm for BCD INFLATOR
I2760102	COMPASS SPANNER
I2760103	ALLEN KEY 2.5mm

MAINTENANCE KIT



CODE	PRODUCT
I2750080	O-RING KIT for BCD INFLATOR
I2750275	O-RING KIT for INFLATOR FLAT

COMPLETE INFLATOR



CODE	PRODUCT
I2750243	COMPLETE INFLATOR for B.C.D.
I2750273	COMPLETE INFLATOR FLAT

SPARE PARTS



TANK BAND

INFLATION HOSE

RIGID BACKREST

UPPER/LOWER BACK VALVE

COMPLETE POWER INFLATOR

CODE	PRODUCT
I2750039	TANK BAND for BCD
I2750040	STANDARD INFLATION HOSE (69cm - 27.16 in) for BCD INFLATOR
I2750060	COMPLETE RIGID BACKREST for B.C.D.
I2750110	UPPER / LOWER BACK VALVE for BCD (LANYARD 70cm + KNOB)
I2750244	COMPLETE POWER INFLATOR



SCUBA

FINS

85YE
MANUFACTURE
QUALITY SINCE
1946

FLOW CONVECTION EFFECT | SPECIAL ARCHED PROFILE

THOR EBS

| ELASTIC BUNGEE SYSTEM

SPECIALIZED Retailer Product | MADE IN ITALY



TECHNICAL FEATURES

- Made using the exclusive 3-material injection system patented by Cressi
- Foot pocket increased by 5%
- Under blade foot pocket
- Very fast transmission of the applied energy
- Great structural rigidity



YELLOW/SILVER | BLUE/SILVER



WHITE/PINK | BLACK/SILVER

Brand new design for this extremely effective and yet, very easy to use fin. The special arched profile of the fins combined with the two central ribs promote a significant flow convection effect, known as "spoon effect", which stabilises and boosts propulsion. Two lateral holes discharge the negative forces

typically associated with this area and, at the same time, make for enhanced stability. The blades are moulded from two different materials for improved reactivity. These fins are perfect for scuba diving, whether you are an experienced diver or a novice.

CODE	COLOR	SIZE	CASE PACK
BE151036	Yellow	XS/S	3
BE151039	Yellow	S/M	3
BE151042	Yellow	L	3
BE151045	Yellow	XL	3
BE152036	Blue	XS/S	3
BE152039	Blue	S/M	3
BE152042	Blue	L	3
BE152045	Blue	XL	3
BE154036	Pink	XS/S	3
BE154039	Pink	S/M	3
BE155036	Black/Silver	XS/S	3
BE155039	Black/Silver	S/M	3
BE155042	Black/Silver	L	3
BE155045	Black/Silver	XL	3

I FLOW CONVECTION EFFECT SPECIAL ARCHED PROFILE



Cressi has developed this special strap to meet the needs of the most demanding divers, who need a comfortable fastening for their foot but one that is still practical and manageable. Its special amply sized slot makes it very easy to put on, even when wearing thick gloves or three-fingered gloves for winter water. The wrapping section is highly flexible, making adjustments unnecessary, and as a result it's much easier to get all your equipment right in the first few meters of your descent and the fin stays in place against your foot despite the increase in hydrostatic pressure.



Wearing fins has never been easier thanks to the special elastic, even with just one hand! The Elastic Bungee Strap holds the fin firmly to the foot and no adjustment is required!



OPTIONAL ACCESSORIES

CODE	PRODUCT
BZ150004	EBS Fin Strap for Ara/Frog/Pro Light/Thor (Short fit)
BZ150005	EBS Fin Strap for Ara/Frog/Pro Light/Thor (Regular fit)
BZ150006	EBS Fin Strap for Ara/Frog/Pro Light/Thor (Extended fit)

SPARE PARTS

CODE	PRODUCT
BZ150004	EBS FIN STRAP for ARA/FROG/PRO LIGHT/THOR - SHORT FIT
BZ150005	EBS FIN STRAP for ARA/FROG/PRO LIGHT/THOR - REGULAR FIT
BZ150006	EBS FIN STRAP for ARA/FROG/PRO LIGHT/THOR - EXTENDED FIT

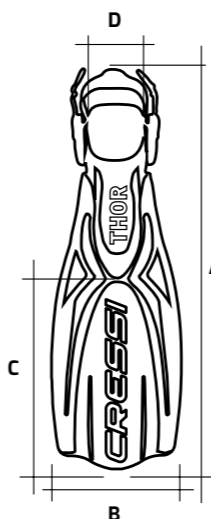

FIT SIZE

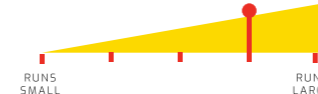

To maximize performance and comfort, wear fins with:

<input type="checkbox"/>	<input type="checkbox"/>	<input checked="" type="checkbox"/>	<input checked="" type="checkbox"/>
BARE FOOT	NEOPRENE SOCKS	NEOPRENE BOOTS (3MM, 5MM, 7MM)	HARD SOLE BOOTS (3MM, 5MM, 7MM)

PRODUCT DIMENSION CHART

FIN SIZE	A LENGTH	B WIDTH	C BLADE	D WIDTH FIT	FIN HEIGHT FIT	SINGLE FIN WEIGHT
XS/S	589 mm	206 mm	325 mm	95 mm	83	760 g
S/M	629 mm	218 mm	346 mm	100 mm	85	850 g
L	668 mm	234 mm	368 mm	108 mm	92	1021 g
XL	680 mm	246 mm	390 mm	114 mm	86	1134 GR

SIZE CONVERSION CHART

EU FOOT SIZE	UK FOOT SIZE	US MEN'S FOOT SIZE	US WOMEN'S FOOT SIZE
36 / 38	3 / 5	4 / 6	5 / 7
39 / 41	6 / 7.5	7 / 8.5	8 / 9.5
42 / 44	8 / 9.5	9 / 10.5	10 / 11.5
45 / 48	10 / 12	11 / 13	12 / 14

CHART MEASUREMENTS TAKEN WITH 3MM BOOT WITH SOLE FINS COULD COME LABELED WITH EU AND UK SIZES ONLY

CRESSI'S SIZE CHART IS TO BE USED AS A REFERENCE ONLY

FLOW CONVENTION EFFECT | SPECIAL ARCHED PROFILE

REACTION EBS

| ELASTIC BUNGEE SYSTEM



I EBS ELASTIC BUNGEE SYSTEM



Cressi's most technically advanced fin, the Reaction uses a completely new polypropylene blade material that is more reactive, flexible and trimmer than previous designs. It kicks easily yet powerfully and is suitable for divers of every experience level. The new, longer blade efficiently transfers energy from the computer-

designed foot pocket, and like other Cressi fins, the blade extends from the top of the foot pocket to maximize its effective surface area for more thrust. Other innovations include new locking strap buckles and no-slip material for better traction out of the water.

Wearing fins has never been easier thanks to the special elastic, even with just one hand! The Elastic Bungee Strap holds the fin firmly to the foot and no adjustment is required!

CODE	COLOR	SIZE	CASE PACK
BE091038	Yellow/Silver	XS/S	3
BE091040	Yellow/Silver	S/M	3
BE091042	Yellow/Silver	M/L	3
BE091044	Yellow/Silver	L/XL	3
BE092038	Blue/Azure	XS/S	3
BE092040	Blue/Azure	S/M	3
BE092042	Blue/Azure	M/L	3
BE092044	Blue/Azure	L/XL	3
BE095538	Black/Silver	XS/S	3
BE095540	Black/Silver	S/M	3
BE095542	Black/Silver	M/L	3
BE095544	Black/Silver	L/XL	3
BE096438	White/Pink	XS/S	3
BE096440	White/Pink	S/M	3



OPTIONAL ACCESSORIES

CODE	PRODUCT
BZ150004	EBS Fin Strap for Ara/Frog/Pro Light/Thor (Short fit)
BZ150005	EBS Fin Strap for Ara/Frog/Pro Light/Thor (Regular fit)
BZ150006	EBS Fin Strap for Ara/Frog/Pro Light/Thor (Extended fit)

SPARE PARTS

CODE	PRODUCT
BZ150004	EBS FIN STRAP for ARA/FROG/PRO LIGHT/THOR - SHORT FIT
BZ150005	EBS FIN STRAP for ARA/FROG/PRO LIGHT/THOR - REGULAR FIT
BZ150006	EBS FIN STRAP for ARA/FROG/PRO LIGHT/THOR - EXTENDED FIT

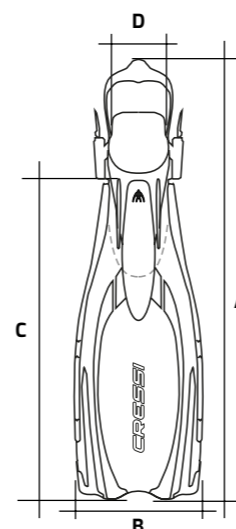

FIT SIZE



PRODUCT DIMENSION CHART							SIZE CONVERSION CHART			
FIN SIZE	A LENGTH	B WIDTH	C BLADE	D WIDTH FIT	FIN HEIGHT FIT	SINGLE FIN WEIGHT	EU FOOT SIZE	UK FOOT SIZE	US MEN'S FOOT SIZE	US WOMEN'S FOOT SIZE
XS/S	587 mm 23 in	201 mm 8 in	325 mm 12.7 in	95 mm 3.7 in	83 mm 3.2 in	760 g 26.8 oz	35 / 38	2 / 4	3 / 5	4 / 6
S/M	621 mm 24.5 in	215 mm 8.4 in	346 mm 13.6 in	100 mm 3.9 in	100 mm 3.9 in	850 g 29.9 oz	38 / 41	4 / 7	5 / 8	6 / 9
M/L	665 mm 26 in	228 mm 8.9 in	368 mm 14.4 in	108 mm 4.2 in	104 mm 4.1 in	1021 g 36.1 oz	41 / 44	7 / 10	8.5 / 11	9.5 / 12
L/XL	698 mm 27.5 in	240 mm 9.4 in	390 mm 15.3 in	114 mm 4.5 in	107 mm 4.2 in	1134 g 40 oz	44 / 47	10 / 13	11 / 13	12 / 14

CHART MEASUREMENTS TAKEN WITH 3MM BOOT WITH SOLE
FINS COULD COME LABELED WITH EU AND UK SIZES ONLY

To maximize performance and comfort, wear fins with:

<input type="checkbox"/>	<input type="checkbox"/>	<input checked="" type="checkbox"/>	<input checked="" type="checkbox"/>
BARE FOOT	NEOPRENE SOCKS	3MM 5MM 7MM NEOPRENE BOOTS	3MM 5MM 7MM HARD SOLE BOOTS

CRESSI'S SIZE CHART IS TO BE USED AS A REFERENCE ONLY

DOUBLE DENSITY TECHNOLOGY | SUPERIOR PERFORMANCE

FROG PLUS



The Frog Plus features many of the great characteristics of a traditional paddle fin while introducing a revolutionary new blade material that is both extremely durable and nearly indestructible. The Frog Plus utilizes Cressi's patented three material injection molding process. The three materials consist of a nice comfortable rubber on the foot pocket that extends up the side rails of the blade. The second material is the revolutionary new dual density techno polymer which forms the blade, and in conjunction with the third silicone-based material, creates a channeling effect. The

channeling effect is the characteristic of the fin that enables a high level of energy to be transferred in both up and down strokes of the kick pattern. The Frog Plus also incorporates Cressi's patented positioning of the foot pocket below the blade. This design increases the working surface area of the blade by 20%. The combination of the channeling effect and the foot pocket mounted beneath the blade creates a very powerful and efficient fin with minimal leg strain. Because of these characteristics, the Frog Plus fin is an ideal choice for the entry-level to advanced diver.

CODE	COLOR	SIZE	CASE PACK
BF202038	Blue/Silver	XS/S	3
BF202040	Blue/Silver	S/M	3
BF202042	Blue/Silver	M/L	3
BF202044	Blue/Silver	L/XL	3
BF203038	White/Black	XS/S	3
BF203040	White/Black	S/M	3
BF203042	White/Black	M/L	3
BF203044	White/Black	L/XL	3
BF205138	Black/Yellow	XS/S	3
BF205140	Black/Yellow	S/M	3
BF205142	Black/Yellow	M/L	3
BF205144	Black/Yellow	L/XL	3
BF205438	Black/Pink	XS/S	3
BF205440	Black/Pink	S/M	3
BF205442	Black/Pink	M/L	3
BF205444	Black/Pink	L/XL	3
BF205538	Black/Silver	XS/S	3
BF205540	Black/Silver	S/M	3
BF205542	Black/Silver	M/L	3
BF205544	Black/Silver	L/XL	3

SPECIALIZED Retailer Product | MADE IN ITALY

TECHNICAL FEATURES

- Double density technology
- Superior performance
- › Possibility of assembly with elastic bungee system (2) possibility of assembly with elastic bungee system (2)
- › Compatible with EBS



OPTIONAL ACCESSORIES

CODE	PRODUCT
BZ170002	Fin Strap for Scuba Fins
BZ170016	Buckles for Frog Plus/Reaction

SPARE PARTS

CODE	PRODUCT
BZ170002	FIN STRAP for SCUBA FINS (not PALAU)
BZ170016	BUCKLES for FROG PLUS/REACTION
BZ150004	EBS FIN STRAP for ARA/FROG/PRO LIGHT/THOR - SHORT FIT
BZ150005	EBS FIN STRAP for ARA/FROG/PRO LIGHT/THOR - REGULAR FIT
BZ150006	EBS FIN STRAP for ARA/FROG/PRO LIGHT/THOR - EXTENDED FIT

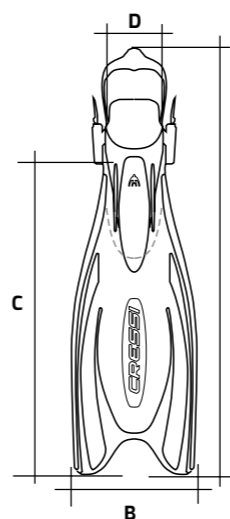

FIT SIZE



To maximize performance and comfort, wear fins with:

	<input type="checkbox"/>	<input checked="" type="checkbox"/>	<input checked="" type="checkbox"/>
BARE FOOT		NEOPRENE SOCKS	NEOPRENE BOOTS

PRODUCT DIMENSION CHART

FIN SIZE	A LENGTH	B WIDTH	C BLADE	D WIDTH FIT	FIN HEIGHT FIT	SINGLE FIN WEIGHT	EU FOOT SIZE	UK FOOT SIZE	US MEN'S FOOT SIZE	US WOMEN'S FOOT SIZE
XS/S	569 mm 22.5 in	198 mm 7.8 in	315 mm 12.5 in	93 mm 3.7 in	83 mm 3.3 in	675 g 24.0 oz	35/38	2 / 5	3 / 6	4 / 7
S/M	606 mm 23.8 in	209 mm 8.2 in	333 mm 13.1 in	99 mm 3.9 in	88 mm 3.5 in	750 g 26.5 oz	38/41	5 / 7	6 / 8	7 / 9
M/L	649 mm 25.5 in	223 mm 8.8 in	355 mm 14 in	104 mm 4.1 in	92 mm 3.6 in	900 g 32.0 oz	41/44	8 / 10	8 / 10	9 / 11
L/XL	683 mm 26.8 in	236 mm 9.3 in	376 mm 14.8 in	112 mm 4.4 in	94 mm 3.7 in	1025 g 36.0 oz	44/47	10 / 11	10 / 13	11 / 14

CHART MEASUREMENTS TAKEN WITH 3MM BOOT WITH SOLE
FINS COULD COME LABELED WITH EU AND UK SIZES ONLY

CRESSI'S SIZE CHART IS TO BE USED AS A REFERENCE ONLY

FROG



A classic in the Cressi range, this has been on the market for many years and has a huge number of appreciators in every corner of the planet. The fin is made with a skillful combination of a strong copolymer and a soft elastomer, the latter used for the foot pocket, for the side stringers, and for some inserts. The blade originates from the upper part of the foot pocket, with a 20% increase in useful surface area compared to a traditional fin of the same length. The foot pocket is computer

designed and offers great comfort; it guarantees excellent transmission of the leg-fin thrust. The Frog is heavier than the more recently designed equivalent Cressi models. It is this feature that makes it agreeable to whoever uses very thick suits or watertight suits. Anyone who works underwater will appreciate this fin a great deal because it is strong and comfortable, very popular also in diving schools and excellent for rental.

CODE	COLOR	SIZE	CASE PACK
BF195038	Black	XS/S	3
BF195040	Black	S/M	3
BF195042	Black	M/L	3
BF195044	Black	L/XL	3
JBF195838	Red	XS/S	3
JBF195840	Red	S/M	3
JBF195842	Red	M/L	3
JBF195844	Red	L/XL	3

OPTIONAL ACCESSORIES

CODE	PRODUCT
BZ170002	Fin Strap for Scuba Fins
BZ170016	Buckles for Frog Plus/Reaction

SPARE PARTS

CODE	PRODUCT
BZ170002	FIN STRAP for SCUBA FINS (not PALAU)
BZ170016	BUCKLES for FROG PLUS/REACTION
BZ150004	EBS FIN STRAP for ARA/FROG/PRO LIGHT/THOR - SHORT FIT
BZ150005	EBS FIN STRAP for ARA/FROG/PRO LIGHT/THOR - REGULAR FIT
BZ150006	EBS FIN STRAP for ARA/FROG/PRO LIGHT/THOR - EXTENDED FIT

FITSIZE



To maximize performance and comfort, wear fins with:



SIZE CONVERSION CHART

EU FOOT SIZE	UK FOOT SIZE	US MEN'S FOOT SIZE	US WOMEN'S FOOT SIZE
36 / 39	2 / 5	4 / 6.5	5 / 7.5
39 / 42	5 / 7	6.5 / 9	7.5 / 10
42 / 45	8 / 10	9 / 11	10 / 12
45 / 47	10 / 11	11 / 12.5	12 / 13.5

⚠️ CHART MEASUREMENTS TAKEN WITH 3MM BOOT WITH SOLE
FINS COULD COME LABELED WITH EU AND UK SIZES ONLY
CRESSI'S SIZE CHART IS TO BE USED AS A REFERENCE ONLY

TECHNICAL FEATURES

- Double density technology
- Superior performance
- › Possibility of assembly with elastic bungee system (2)
- › Compatible with EBS



BLACK RED



PRO LIGHT



These highly responsive blades are also very lightweight, and a great choice for traveling divers who want an open-heel fin. The dual-material blade balances power with kicking

comfort, and full-length side rails help it track naturally through the water using a standard scissor kick. The soft elastomer foot pocket is shaped for an ergonomic and comfortable fit.

TECHNICAL FEATURES

- Dual material blade uses strong polypropylene and soft elastomer
- Full length side-rails help direct waterflow for improved thrust
- Elastomer foot pocket improves comfort
- Blade extends from the top of the foot for increased surface area
- Quick-release strap buckles
- › Possibility of assembly with elastic bungee system (2)
- › Compatible with EBS



YELLOW BLUE



BLACK

CODE	COLOR	SIZE	CASE PACK
BG171038	Yellow	XS	3
BG171040	Yellow	S/M	3
BG171042	Yellow	M/L	3
BG171044	Yellow	XL	3
BG172038	Blue	XS	3
BG172040	Blue	S/M	3
BG172042	Blue	M/L	3
BG172044	Blue	XL	3
BG175038	Black	XS	3
BG175040	Black	S/M	3
BG175042	Black	M/L	3
BG175044	Black	XL	3
BG175046	Black	2XL	3

OPTIONAL ACCESSORIES

CODE	PRODUCT
BZ170002	Fin Strap for Scuba Fins
BZ170016	Buckles for Frog Plus/Reaction

SPARE PARTS

CODE	PRODUCT
BZ170002	FIN STRAP for SCUBA FINS (not PALAU)
BZ170016	BUCKLES for FROG PLUS/REACTION
BZ150004	EBS FIN STRAP for ARA/FROG/PRO LIGHT/THOR - SHORT FIT
BZ150005	EBS FIN STRAP for ARA/FROG/PRO LIGHT/THOR - REGULAR FIT
BZ150006	EBS FIN STRAP for ARA/FROG/PRO LIGHT/THOR - EXTENDED FIT

FITSIZE



To maximize performance and comfort, wear fins with:



PRODUCT DIMENSION CHART

FIN SIZE	A LENGTH	B WIDTH	C BLADE	D WIDTH FIT	FIN HEIGHT FIT	SINGLE FIN WEIGHT
XS	575 mm 22.6 in	198 mm 7.8 in	312 mm 12.3 in	97 mm 3.9 in	84 mm 3.3 in	675 g 23.8 oz
S/M	608 mm 23.9 in	211 mm 8.3 in	332 mm 13.1 in	107 mm 4.2 in	89 mm 3.5 in	795 g 28.0 oz
M/L	648 mm 25.5 in	223 mm 8.8 in	354 mm 14 in	112 mm 4.4 in	94 mm 3.7 in	935 g 33.0 oz
XL	679 mm 26.7 in	233 mm 9.2 in	372 mm 14.7 in	117 mm 4.6 in	95 mm 3.8 in	1015 g 35.8 oz
XXL	688 mm 27 in	242 mm 9.6 in	374 mm 14.8 in	124 mm 4.9 in	95 mm 3.8 in	1100 g 38.8 oz

SIZE CONVERSION CHART

EU FOOT SIZE	UK FOOT SIZE	US MEN'S FOOT SIZE	US WOMEN'S FOOT SIZE
35 / 38	2 / 4	4 / 6.5	5 / 7.5
38 / 41	4 / 7	6.5 / 8	7.5 / 9
41 / 44	7 / 10	8.5 / 11	9.5 / 12
44 / 45	10 / 11	11 / 12	12 / 13
46 / 47	11 / 12	12 / 13	13 / 14

⚠️ CHART MEASUREMENTS TAKEN WITH 3MM BOOT WITH SOLE
FINS COULD COME LABELED WITH EU AND UK SIZES ONLY

CRESSI'S SIZE CHART IS TO BE USED AS A REFERENCE ONLY



MAUI

NEW 2022

I OPEN HEEL SNORKELING FINS



TECHNICAL FEATURES

- Short blade adjustable open heel fins.
- Elastic Bungee Strap (EBS) system patented by Cressi.
- Colored strap by size for dive centers.



BLUE

BLACK / RED

EBS STRAPS FOR DIVE CENTERS

Dive Centers fins will have heel pieces colour-coded according to sizes to facilitate identification. Only on black/red version.



S/M
RED STRAP

M/L
BLACK STRAP

L/XL
GREY STRAP

The principal characteristics of the Maui fin are lightness and ease of use, even for those without well-trained legs. Its weight and dimensions make it easy to stow, but without compromising performance.

The Maui has been designed with the same sophisticated and advanced finite elements technology used for the first time on the Impulse and Sprint models.

The dual material technology used for the blade means that it is substantially composed of two rigid lateral wings that direct the flow of water to the central section, where the overlaying of a softer and more elastic material makes it more flexible. In this way the blade flexes to create a "spoon effect", thereby contributing considerable propulsive force.

The fin can be used with bare feet or light socks. The fabric covering of the EBS strap prevents perishing of the elastic elements. The heel piece is in soft, anatomical rubber. The grab handle for fitting the fin wraps around the ankle so as to reduce protrusion and avoid chafing while swimming.

Even though the EBS itself permits great adaptability and makes donning the fin particularly easy, we have fitted a cleat to the elastic strap to permit further adjustment. This function permits the user to obtain micro-adjustments – depending on whether they are wearing a sock or not – or simply to loosen or tighten to ensure the foot is held firmly in place but without excessive pressure. Dive Centres fins will have heel pieces colour-coded according to sizes to facilitate identification.

CODE	COLOR	SIZE	CASE PACK
CA155238	Blue	S/M	3
CA155241	Blue	M/L	3
CA155244	Blue	L/XL	3
CA155838	Black/Red	S/M	3
CA155841	Black/Red	M/L	3
CA155844	Black/Red	L/XL	3



ELASTIC BUNGEE STRAP (EBS)



HOOK HOLDER



HEEL COLOR - CODED PIECES



SPARE PARTS

CODE	PRODUCT
CZ145200	EBS STRAPS MAUI - BLUE (pair)
CZ145500	EBS STRAPS MAUI - BLACK (pair)
CZ145550	EBS STRAPS MAUI - GREY (pair)
CZ145800	EBS STRAPS MAUI - RED (pair)

SHORTER FOOT POCKET | SHORTER BLADE | HIGH PROPULSIVE PERFORMANCE

SPECIALIZED Retailer Product | MADE IN ITALY

GARA MODULAR SPRINT TURBO NEW 2022

| 29° DEGREE ANGLED INTERCHANGEABLE BLADE



TECHNICAL FEATURES

- Excellent propulsive performance without tiring anyone, beginners or professionals
- Thermoplastic rubber foot pocket, certified Full Contact
- Standard blade/stringer interface with screws under the foot pocket and side clips
- Extremely thin and light blade in compound made of elastomerized technopolymers developed by Cressi with different thicknesses
- Stringer consisting of technopolymers with elastomeric loads with high flexural modulus
- Foot pocket/blade angle of 29 degrees
- All fin components are also supplied separately.



The Gara Sprint Turbo fin is a shorter version of the Gara Turbo fin. Sprint is designed to meet the needs of freedivers and spearfishers who practice this sport in wintertime and when a blade as long as Impulse is not necessary. Both fins have been designed using expensive finite element software programs that allow highly complex and equally high-performance sections to be defined.

The blade of Sprint, like the Impulse blade, is made of a single thermoplastic elastomer, although it would be more correct to refer to an angled sublayer and an overlay. The sublayer follows the shape and dimensions of almost the entire fin. It has a uniform thickness and a flexible longitudinal propulsion wing of variable length. When disassembled, the blade and foot pocket occupy the space of a normal snorkeling fin.

WATER RAILS SYSTEM

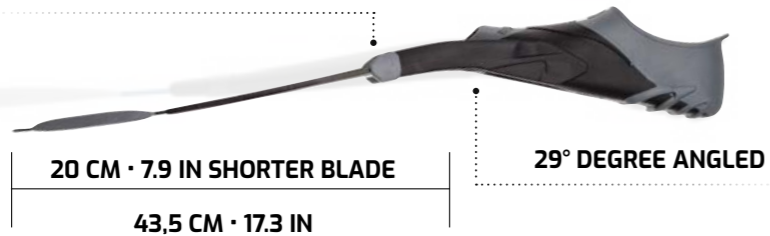

INCLUDED GARA MODULAR INSOLE

The insole for Gara Modular fins is recommended for use with thin boots in temperate waters, because it improves the kick performance. The semi-rigid material of the insole is completely recycled. The insoles are supplied as a pair (right and left foot) and can be cut into their shape in three different sizes, according to pre-printed guidelines.

- Down-size Gara Fins foot pocket preformed sole
- Easily adjust size
- Non-corrosive plastic construction



CODE	COLOR	SIZE	CASE PACK
BH175036	Black	36/37	3
BH175038	Black	38/39	3
BH175040	Black	40/41	3
BH175042	Black	42/43	3
BH175044	Black	44/45	3
BH175046	Black	46/47	3



OPTIONAL ACCESSORIES

CODE	PRODUCT
BZ175032	RUBBER FIN KEEPER (PAIR) - BLACK (S)
BZ175033	RUBBER FIN KEEPER (PAIR) - BLACK (M)
BZ175034	RUBBER FIN KEEPER (PAIR) - BLACK (L)
BZ180022	INSOLE FOR GARA FINS

SPARE PARTS

CODE	PRODUCT
BZ180020	GARA MODULAR ASSEMBLY KIT
BH015036	GARA MODULAR TURBO FOOT POCKET [36/37]
BH015038	GARA MODULAR TURBO FOOT POCKET [38/39]
BH015040	GARA MODULAR TURBO FOOT POCKET [40/41]
BH015042	GARA MODULAR TURBO FOOT POCKET [42/43]
BH015044	GARA MODULAR TURBO FOOT POCKET [44/45]
BH015046	GARA MODULAR TURBO FOOT POCKET [46/47]

FITSIZE



To maximize performance and comfort, wear fins with:

✓	✓		
BARE FOOT	NEOPRENE SOCKS	NEOPRENE BOOTS	HARD SOLE BOOTS

FIN SIZE	PRODUCT DIMENSION CHART					SIZE CONVERSION CHART			
	A LENGTH	B WIDTH	C BLADE	FIN HEIGHT FIT	SINGLE FIN WEIGHT	EU FOOT SIZE	UK FOOT SIZE	US MEN'S FOOT SIZE	US WOMEN'S FOOT SIZE
36 / 37	671 mm 26.4 in	215 mm 8.5 in	430 mm 16.9 in	83 mm 3.3 in	678 g 23.9 oz	36 / 37	3 / 4	4 / 5	5 / 6
37 / 38	683 mm 26.9 in	215 mm 8.5 in	430 mm 16.9 in	84 mm 3.3 in	712 g 25.1 oz	37 / 38	5 / 6	6 / 7	7 / 8
39 / 40	700 mm 27.6 in	215 mm 8.5 in	430 mm 16.9 in	87 mm 3.4 in	738 g 26.0 oz	39 / 40	6.5 / 7	7.5 / 8	8.5 / 9
41 / 42	712 mm 28.0 in	215 mm 8.5 in	430 mm 16.9 in	92 mm 3.6 in	783 g 27.6 oz	41 / 42	8 / 9	9 / 10	10 / 11
43 / 44	725 mm 28.5 in	215 mm 8.5 in	430 mm 16.9 in	97 mm 3.8 in	848 g 29.9 oz	43 / 44	10 / 10.5	11 / 11.5	12 / 12.5
45 / 46	734 mm 28.9 in	215 mm 8.5 in	430 mm 16.9 in	103 mm 4.1 in	916 g 32.3 oz	45 / 46	11 / 12	12 / 13	13 / 14

⚠ CHART MEASUREMENTS TAKEN WITH 3MM BOOT WITH SOLE
FINS COME LABELED WITH EU AND UK SIZES ONLY

CRESSI'S SIZE CHART IS TO BE USED AS A REFERENCE ONLY

GARA MODULAR SPRINT

| 29° DEGREE ANGLED INTERCHANGEABLE BLADE



TECHNICAL FEATURES

- Excellent propulsive performance without fatigue, ideal for beginners or professionals
- Thermoplastic rubber foot pocket, certified Full Contact
- Standard blade/stringer interface with screws under the foot pocket and side clips
- Extremely thin and light blade in compound made of elastomerized technopolymers developed by Cressi with different thicknesses
- Stringer consisting of technopolymers with elastomeric loads with high flexural moduli
- Foot pocket/blade angle of 29 degrees

- » All fin components are also supplied separately
- » INTERCHANGEABLE BLADE
- » SUPERIOR PERFORMANCE
- » SUPERIOR COMFORT
- » SELF ADJUSTING FOOT POCKET

The new Gara Modular Sprint fin is a shorter version of the Impulse fin, which proved to be hugely popular with freedivers worldwide, both amateurs and the most demanding professional freedivers. This is also confirmed by the large number of articles dedicated to it by specialized journalists in sector magazines.

Sprint is designed to meet the needs of freedivers and spearfishers who practice this sport in wintertime and when a fin as long as Impulse is not necessary. Both fins have been designed using expensive finite element software programs that allow highly complex and equally high performance sections to be defined. The blade of Sprint, like the Impulse blade, is made of a single thermoplastic elastomer, although it would be more correct

to refer to an angled sublayer and an overlay. The sublayer follows the shape and dimensions of almost the entire fin. It has a uniform thickness and a flexible longitudinal propulsion wing of variable length. In contrast, the so-called overlay covers the propulsion wing selectively and has a thickness that slopes from the maximum value to zero longitudinally towards the tip of the blade. As a result, the fin offers a new way of storing and releasing elastic potential energy, greatly assisting movement of the freediver's legs and thus guaranteeing a net improvement in propulsive output. When disassembled, the blade and foot pocket occupy the space of a normal snorkeling fin.

CODE	COLOR	SIZE	CASE PACK
BH082036	Blue	36/37	3
BH082038	Blue	38/39	3
BH082040	Blue	40/41	3
BH082042	Blue	42/43	3
BH082044	Blue	44/45	3
BH082046	Blue	46/47	3
BH085036	Black	36/37	3
BH085038	Black	38/39	3
BH085040	Black	40/41	3
BH085042	Black	42/43	3
BH085044	Black	44/45	3
BH085046	Black	46/47	3

ACCESSORIES

CODE	PRODUCT
BZ175032	RUBBER FIN KEEPER (PAIR) - BLACK (S)
BZ175033	RUBBER FIN KEEPER (PAIR) - BLACK (M)
BZ175034	RUBBER FIN KEEPER (PAIR) - BLACK (L)
BZ180022	INSOLE FOR GARA FINS

SPARE PARTS

CODE	PRODUCT
BZ180020	GARA MODULAR ASSEMBLY KIT
BH005036	GARA MODULAR FOOT POCKET (PAIR) [36/37]
BH005038	GARA MODULAR FOOT POCKET (PAIR) [38/39]
BH005040	GARA MODULAR FOOT POCKET (PAIR) [40/41]
BH005042	GARA MODULAR FOOT POCKET (PAIR) [42/43]
BH005044	GARA MODULAR FOOT POCKET (PAIR) [44/45]
BH005046	GARA MODULAR FOOT POCKET (PAIR) [46/47]

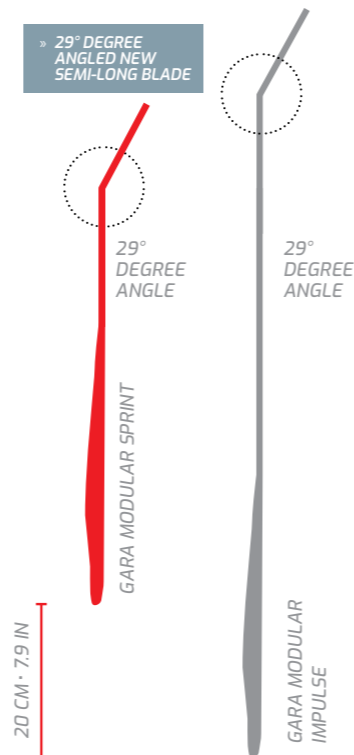

REACTION PRO

The Reaction Pro is a great all around fin for scuba, snorkeling and freediving. The Reaction Pro is a full foot pocket style fin, with a long blade and built in runners to effectively direct water flow down the blade. The Reaction Pro is constructed using multiple materials, bonded together with our patented three-material molding process. This provides comfort and suppleness in the foot area as well as strength and rigidity in the heel and blade for added power and efficiency. The soles are completely covered in thermo-rubber to give them exceptional grip on boat decks. Can comfortably be worn with or without dive socks.



TECHNICAL FEATURES

- Excellent propulsive performance
- Full footpocket for comfort
- Long blade for efficiency
- Thermo-Rubber soles for extra grip on wet surfaces



CODE	COLOR	SIZE	CASE PACK
BG192036	Blue	36/37	3
BG192038	Blue	38/39	3
BG192040	Blue	40/41	3
BG192042	Blue	42/43	3
BG192044	Blue	44/45	3
BG192046	Blue	46/47	3
BG195036	Black	36/37	3
BG195038	Black	38/39	3
BG195040	Black	40/41	3
BG195042	Black	42/43	3
BG195044	Black	44/45	3
BG195046	Black	46/47	3

ACCESSORIES

CODE	PRODUCT
BZ175032	RUBBER FIN KEEPER (PAIR) - BLACK (S)
BZ175033	RUBBER FIN KEEPER (PAIR) - BLACK (M)
BZ175034	RUBBER FIN KEEPER (PAIR) - BLACK (L)

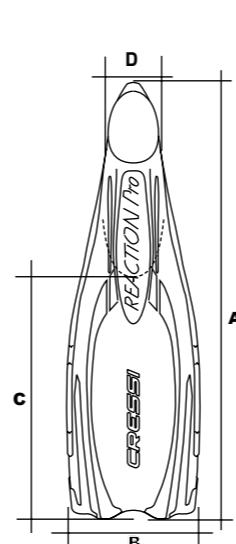

FITSIZE



FIN SIZE	PRODUCT DIMENSION CHART				SIZE CONVERSION CHART			
	A LENGTH	B WIDTH	C BLADE	SINGLE FIN WEIGHT	EU FOOT SIZE	UK FOOT SIZE	US MEN'S FOOT SIZE	US WOMEN'S FOOT SIZE
36/37	600 mm 23.6 in	203 mm 8 in	475 mm 18.8 in	625 g 22.0 oz	36/37	3 / 4	4 / 5	5 / 6
38/39	620 mm 24.5 in	215 mm 8.5 in	495 mm 19.5 in	710 g 25.0 oz	38/39	5 / 6	6 / 7	7 / 8
40/41	640 mm 25.2 in	215 mm 8.5 in	500 mm 19.7 in	765 g 27.0 oz	40/41	6.5 / 7	7.5 / 8	8.5 / 9
42/43	665 mm 26.2 in	215 mm 8.5 in	520 mm 20.5 in	830 g 29.2 oz	42/43	8 / 9	9 / 10	10 / 11
44/45	680 mm 26.8 in	215 mm 8.5 in	545 mm 21.5 in	880 g 31.0 oz	44/45	10 / 10.5	11 / 11.5	12 / 12.5
46/47	700 mm 27.5 in	215 mm 8.5 in	555 mm 21.9 in	935 g 33.0 oz	46/47	11 / 12	12 / 13	13 / 14

⚠️ FINS COULD COME LABELED WITH EU AND UK SIZES ONLY

CRESSI'S SIZE CHART IS TO BE USED AS A REFERENCE ONLY

To maximize performance and comfort, wear fins with:

<input checked="" type="checkbox"/>	<input checked="" type="checkbox"/>	<input type="checkbox"/>	<input type="checkbox"/>
BARE FOOT	NEOPRENE SOCKS	NEOPRENE BOOTS	HARD SOLE BOOTS

VERSATILE AND LIGHTWEIGHT | COMFORTABLE FULL FOOT POCKET

PRO STAR

The Pro Star is another versatile fin in the Cressi line and is an exceptional choice for Scuba, Snorkeling and Freediving. Inspired by the Pro Light, the Pro Star is a lightweight and comfortable full footpocket style fin. For power transference, it incorporates the blade beneath the footpocket and the angle of the blade provides the ultimate in efficiency during the kick cycle, requiring less energy to load the blade. This fin is constructed using multiple compounds bonded together to provide comfort around the foot, yet strong enough to transfer strength where needed. Can comfortably be worn with or without neoprene socks.



TECHNICAL FEATURES

- Full footpocket for comfort
- Long blade for efficiency



YELLOW BLACK

CODE	COLOR	SIZE	CASE PACK
BG181037	Yellow	37/38	4
BG181039	Yellow	39/40	4
BG181041	Yellow	41/42	4
BG181043	Yellow	43/44	4
BG181045	Yellow	45/46	4
BG185037	Black	37/38	4
BG185039	Black	39/40	4
BG185041	Black	41/42	4
BG185043	Black	43/44	4
BG185045	Black	45/46	4

ACCESSORIES

CODE	PRODUCT
BZ175032	RUBBER FIN KEEPER (PAIR) - BLACK (S)
BZ175033	RUBBER FIN KEEPER (PAIR) - BLACK (M)
BZ175034	RUBBER FIN KEEPER (PAIR) - BLACK (L)

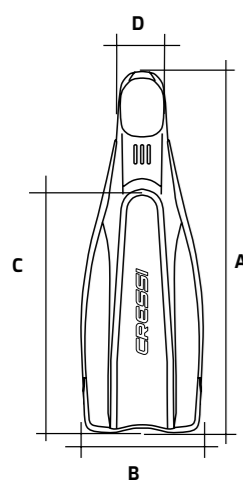

FIT SIZE



To maximize performance and comfort, wear fins with:

<input checked="" type="checkbox"/>	<input checked="" type="checkbox"/>	<input type="checkbox"/>	<input type="checkbox"/>
BARE FOOT	NEOPRENE SOCKS	NEOPRENE BOOTS	HARD SOLE BOOTS

PRODUCT DIMENSION CHART							SIZE CONVERSION CHART			
FIN SIZE	A LENGTH	B WIDTH	C BLADE	D WIDTH FIT	FIN HEIGHT FIT	SINGLE FIN WEIGHT	EU FOOT SIZE	UK FOOT SIZE	US MEN'S FOOT SIZE	US WOMEN'S FOOT SIZE
37/38	607 mm 23.9 in	201 mm 8 in	358 mm 14.1 in	90 mm 3.6 in	71 mm 2.8 in	578 g 20.4 oz	37/38	4 / 5	5.5 / 6.5	6.5 / 7.5
39/40	628 mm 24.8 in	208 mm 8.2 in	365 mm 14.4 in	93 mm 3.7 in	71 mm 2.8 in	623 g 22.0 oz	39/40	5.5 / 6.5	7 / 8	8 / 9
41/42	647 mm 25.5 in	214 mm 8.5 in	373 mm 14.7 in	97 mm 3.8 in	74 mm 2.9 in	646 g 22.8 oz	41/42	7 / 8	8.5 / 9.5	9.5 / 10.5
43/44	671 mm 26.4 in	219 mm 8.6 in	380 mm 15 in	100 mm 3.9 in	76 mm 3 in	725 g 25.6 oz	43/44	8.5 / 9.5	10 / 11	11 / 12
45/46	688 mm 27.1 in	223 mm 8.8 in	387 mm 15.3 in	102 mm 4.1 in	77 mm 3 in	782 g 27.6 oz	45/46	10 / 11	11.5 / 12.5	12.5 / 13.5

⚠️ FINS COULD COME LABELED WITH EU AND UK SIZES ONLY

CRESSI'S SIZE CHART IS TO BE USED AS A REFERENCE ONLY

ALSO FOR RENTAL | MADE IN ITALY

FREE FROG

The Free Frog is back! The fin has been remade with the new molding technology. The foot pocket has been improved to fit better to most different foot shapes.

The Free Frog enjoys the exclusive characteristics of the Cressi diving fins maintaining the spirit of the legendary Frog. It features a below blade foot pocket in order to have a bigger surface that increases the kicking thrust. It is manufactured in a variant of low-modulus polypropylene that, combined with a particular structure, combines a great flexibility, softness, and resistance to a demanding use (even in rental and instructional facilities), durability and an unprecedented aesthetics in fins projected with this philosophy.



BLACK RED

» Restyled foot pocket: wider and softer



BACK VIEW

CODE	COLOR	SIZE	CASE PACK
BR155037	Black	37/38	3
BR155039	Black	39/40	3
BR155041	Black	41/42	3
BR155043	Black	43/44	3
BR155045	Black	45/46	3
JBR155837	Red	37/38	3
JBR155839	Red	39/40	3
JBR155841	Red	41/42	3
JBR155843	Red	43/44	3
JBR155845	Red	45/46	3

ACCESSORIES

CODE	PRODUCT
BZ175032	RUBBER FIN KEEPER (PAIR) - BLACK (S)
BZ175033	RUBBER FIN KEEPER (PAIR) - BLACK (M)
BZ175034	RUBBER FIN KEEPER (PAIR) - BLACK (L)

FIT SIZE



To maximize performance and comfort, wear fins with:

<input checked="" type="checkbox"/>	<input checked="" type="checkbox"/>	<input type="checkbox"/>	<input type="checkbox"/>
BARE FOOT	NEOPRENE SOCKS	NEOPRENE BOOTS	HARD SOLE BOOTS

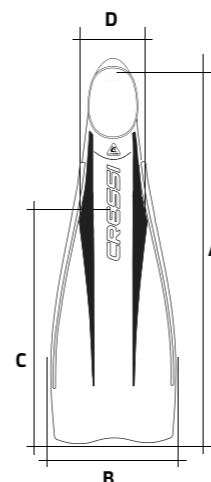

PRODUCT DIMENSION CHART							SIZE CONVERSION CHART			
FIN SIZE	A LENGTH	B WIDTH	C BLADE	D WIDTH FIT	FIN HEIGHT FIT	SINGLE FIN WEIGHT	EU FOOT SIZE	UK FOOT SIZE	US MEN'S FOOT SIZE	US WOMEN'S FOOT SIZE
37 / 38	607 mm 23.9 in	201 mm 7.9 in	358 mm 14.1 in	90 mm 3.5 in	71 mm 2.8 in	578 g 20.4 oz	37/38	4 / 5	5 / 6	6 / 7
39 / 40	628 mm 24.7 in	208 mm 8.2 in	365 mm 14.4 in	93 mm 3.7 in	71 mm 2.8 in	623 g 22.0 oz	39/40	5.5 / 6.5	6.5 / 7.5	7.5 / 8.5
41 / 42	647 mm 25.5 in	214 mm 8.4 in	373 mm 14.7 in	97 mm 3.8 in	74 mm 2.9 in	646 g 22.8 oz	41/42	7 / 8	8 / 9	9 / 10
43 / 44	671 mm 26.4 in	219 mm 8.6 in	389 mm 15.0 in	100 mm 3.9 in	76 mm 3.0 in	725 g 23.7 oz	43/44	8.5 / 9.5	9.5 / 10.5	10.5 / 11.5
45 / 46	688 mm 27.1 in	223 mm 8.8 in	387 mm 15.2 in	102 mm 4.0 in	77 mm 3.0 in	782 g 24.3 oz	45/46	10/11	11/12	12/13

⚠️ CHART MEASUREMENTS TAKEN WITH 3MM BOOT WITH SOLE FINS COULD COME LABELED WITH EU AND UK SIZES ONLY

CRESSI'S SIZE CHART IS TO BE USED AS A REFERENCE ONLY

ELASTIC BUNGEE SYSTEM

Cressi has developed this special strap to meet the needs of the most demanding divers, who need a comfortable fastening for their foot that is still practical and manageable. Its amply sized slot makes it very easy to put on, even when wearing

thick gloves or three-fingered gloves. The wrapping section is highly flexible, making adjustments while underwater unnecessary. The EBS system ensures fins will stay in place against your foot despite the increase in hydrostatic pressure.



ELASTIC BUNGEE SYSTEM (1) Designed for Ara / Frog / Pro Light / Thor



CODE	PRODUCT	FIN SIZE
BZ150004	EBS Fin Strap - Short Fit - Pair	XS/S - S/M
BZ150005	EBS Fin Strap - Regular Fit - Pair	S/M - M/L
BZ150006	EBS Fin Strap - Extended Fit - Pair	M/L - L/XL

ELASTIC BUNGEE SYSTEM (2) Designed for Frog Plus / Reaction



CODE	PRODUCT	FIN SIZE
BZ150001	EBS Fin Strap - Short Fit - Pair	XS/S - S/M
BZ150002	EBS Fin Strap - Regular Fit - Pair	S/M - M/L
BZ150003	EBS Fin Strap - Extended Fit - Pair	M/L - L/XL

STANDARD FIN STRAP



Straps for open heel fins are made with long lasting rubber. The strap is padded in the area which is in contact with the back of the heel,

to ensure better comfort. Each strap is designed with ridges to adjust the length by use of the buckles.

CODE	PRODUCT
BZ170002	Fin Strap (Compatibility all scuba fins) - Pair
BZ170015	Buckles (1) (Frog I Pro Light I Thor) - Pair
BZ170016	Buckles (2) (Frog Plus I Reaction) - Pair

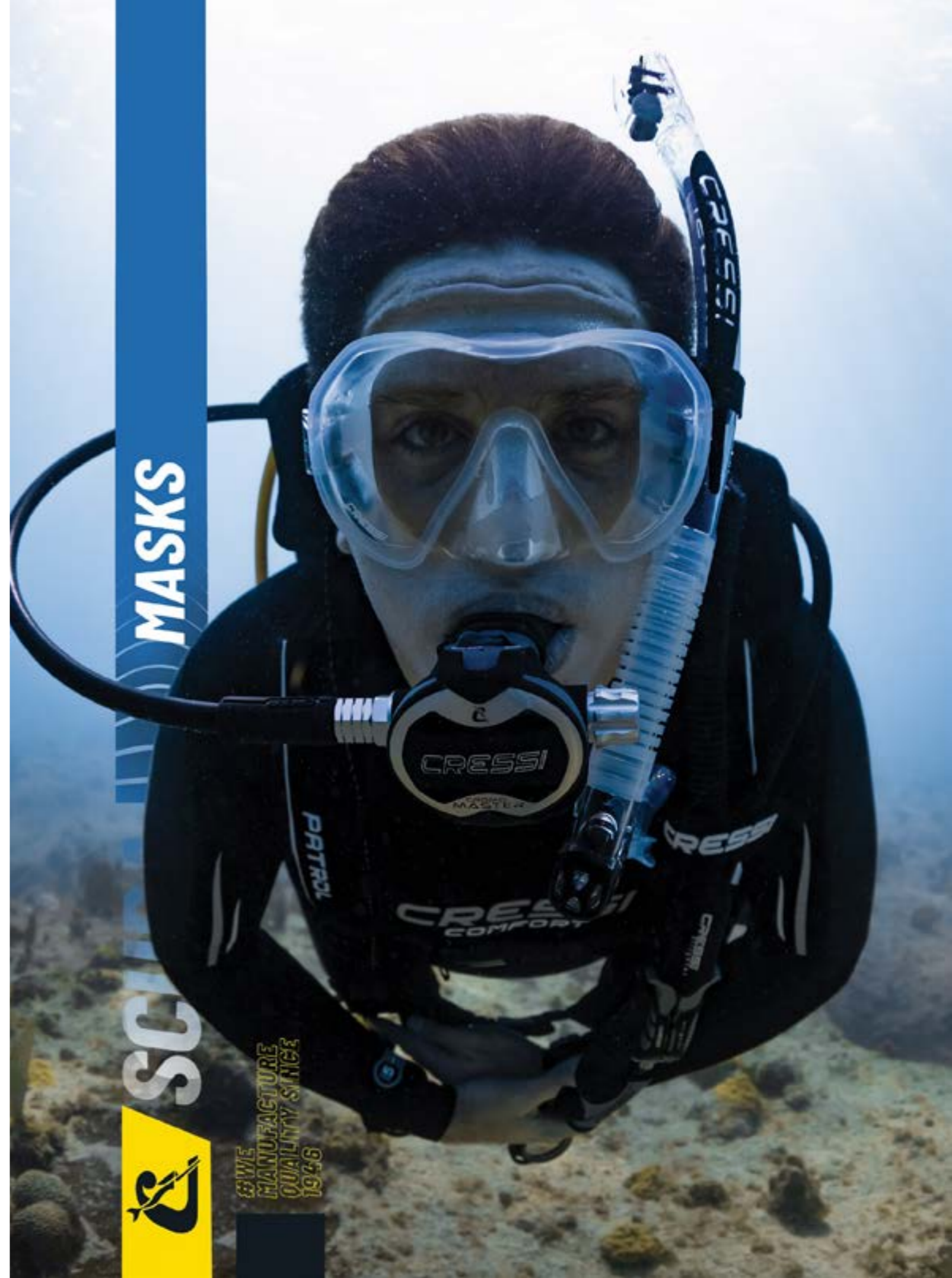

SCUBA

85YE
MANUFACTURE
QUALITY SINCE
1961



QUANTUM NEW 2022

I NEW REVOLUTIONARY ANTI-FOG SYSTEM

The major innovation with the Quantum mask is that as well as offering enhanced downwards vision it avoids the fogging phenomenon through the internal thermoregulation of the warm, damp air exiting the nose. This air is channelled by a system of membranes set in the moulding around the eyes and nose and deviating

the flow towards the rubber skirt rather than the lenses.

The external part of the skirt features a cooling system composed of two small heat exchangers that act as radiators. The effect is that the temperature inside mask drops, coming closer to the external temperature and the droplets of humidity

are trapped before the air reaches the lenses, preventing them from fogging up.

Despite the presence of the small internal membranes deviating the air flow and the external heat exchangers, the body of the Quantum mask is nonetheless compact and represents the most advanced design offered on the underwater vision market.

PATENTED ANTI-FOG SYSTEM | DOUBLE INJECTION TECHNOLOGY | INCLINED LENSES | SELF ADJUSTING FOOT POCKET | FLEXIBLE BUCKLE WITH MICROMETRIC ADJUSTMENT | BI-SILICONE STRAP | TEMPERED GLASS | 100% HIGH QUALITY



DOUBLE INJECTION SILICONE STRAP



The lenses are not treated chemically and it should be remembered that when the mask is new, as is the case with all masks, we advise you to clean the lenses carefully with water and proper detergent for dive mask lenses.

INNER MEMBRANES + HEAT EXCHANGER



INNER MEMBRANES
A patented membrane surrounding the inner nose pocket (1) and both the inner eyes pockets (2) which acts as a barrier and traps any moisture escaping from the diver's nose involuntarily when breathing through the mouth. The result is that not only is the moisture channelled away from the lenses, thus avoiding the fogging up of them, but it also reduces the need to compensate for pressure.
To further improve the anti-fog effect, Cressi suggests, the first times that the dive mask is used, to spray some anti-fog solution or to apply some saliva on the inside of the lenses and then to rinse them with water.

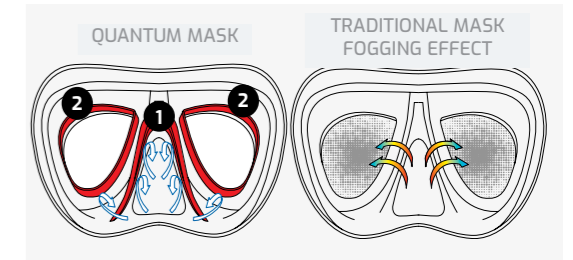

HEAT EXCHANGER
The external part of the skirt features a cooling system composed of two small heat exchangers that act as radiators (3). Thanks to this system, the temperature inside mask drops, coming closer to the external temperature and the droplets of humidity are trapped before the air reaches the lenses, preventing them from fogging up.

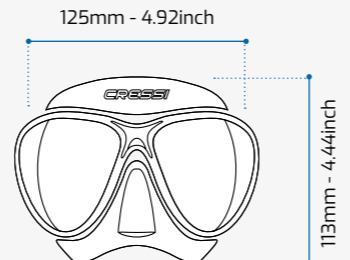

CODE	COLOR	CASE PACK
DS510020	Clear/Blue	6
DS510040	Clear/Pink	6
DS510050	Clear/Black	6
DS512020	Blue Metal	6
DS515010	Black/Yellow	6
DS515020	Black/Blue	6
DS515050	Black/Black	6
DS515080	Black/Red	6

SPARE PARTS

CODE	PRODUCT
DZ215009	STRAP LOOP SMALL for PRO DIVE MASKS - CLEAR (PAIR)
DZ215011	STRAP LOOP SMALL for PRO DIVE MASKS - BLACK (PAIR)

- U.S. PAT 6272693 B1
- DOUBLE INJECTION TECHNOLOGY
- CERTIFIED EN 250/2014 FOR COLD WATERS
- IDF-TECHNOLOGY INTEGRATED DUAL FRAME
- INCLINED LENSES
- FLEXIBLE BUCKLE
- TEMPERED GLASS
- 100% HIGH QUALITY SILICONE SKIRT



ZEUS

| NEW BUCKLE WITH LARGER BUTTON
| DOUBLE INJECTION SILICONE STRAP



Zeus is the perfect mask for diving. This mask has a particular tapered structure deriving directly from the highly popular Nano-mask patent. The same IDF-INTEGRATED DUAL FRAME TECHNOLOGY SYSTEM allows you to join the silicone skirt to the lens frame without

major interruptions of the curvature continuity. The result is a mask with an extremely hydrodynamic shape and, visibility being equal, a significantly smaller size. The field of view obtained is particularly wide, laterally and in the lower zone.

TECHNICAL FEATURES

- **Fog stop system:** inner nose pocket new Patent pending
- A patented membrane surrounding the inner nose pocket which acts as a barrier and traps any moisture escaping from the diver's nose involuntarily when breathing through the mouth. Not only is the moisture channeled away from the lenses, thus avoiding the fogging up of them, but it also reduces the need to compensate for pressure
- To further improve the anti-fog effect, Cressi suggests, the first times that the dive mask is used, to spray some anti-fog solution or to apply some saliva on the inside of the lenses and then to rinse them with water
- Thanks to its matte coating, the mask's components all match, enhancing the underwater experience since it prevents reflections in the water that may disturb marine life
- The new micrometric adjustable buckles, with a larger button, allow a more easier regulation while also wearing dive gloves.
- The new strap is made of two different silicone colors

- > U.S. PAT 6272693 B1
- > DOUBLE INJECTION TECHNOLOGY
- > IDF-TECHNOLOGY INTEGRATED DUAL FRAME
- > INCLINED LENSES
- > FLEXIBLE BUCKLE
- > TEMPERED GLASS

DOUBLE INJECTION SILICONE STRAP



CODE	COLOR	CASE PACK
DS470020	Clear/Blue	6
DS470040	Clear/Pink	6
DS470050	Clear/Black	6
DS470058	Clear/Red	6
DS475009	Black/Gold	6
DS475050	Black/Black	6
DS4750509	Black/Black, Iridium Lens	6
DS475051	Black/Silver	6
DS475058	Black/Red	6
DS475150	Dark Grey/Black	6
DS475550	Blue/Blue	6

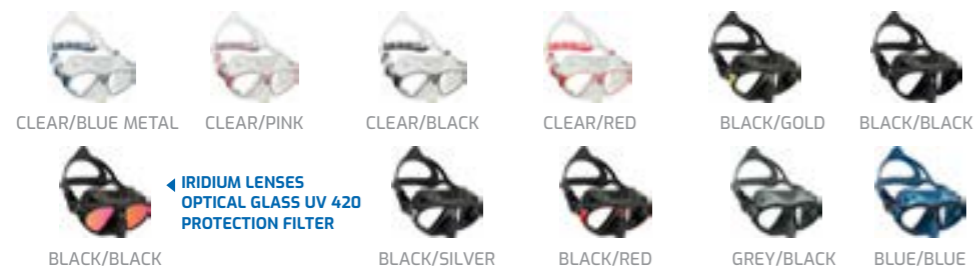

IRIDIUM LENSES
OPTICAL GLASS UV 420
PROTECTION FILTER

INNER NOSE POCKET -
NEW PATENT PENDING

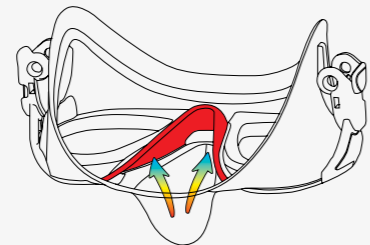

PACKAGING



SPARE PARTS

CODE	PRODUCT
DZ215009	STRAP LOOP SMALL for PRO DIVE MASKS - CLEAR (PAIR)
DZ215011	STRAP LOOP SMALL for PRO DIVE MASKS - BLACK (PAIR)

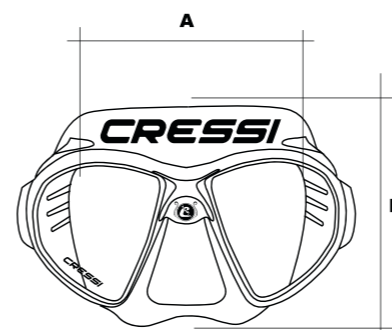

PRODUCT DIMENSION CHART (SKIRT SIZE)

A WIDTH (mm)	B HEIGHT (mm)	A WIDTH (in)	B HEIGHT (in)
116	108	4 9/16	4 4/16

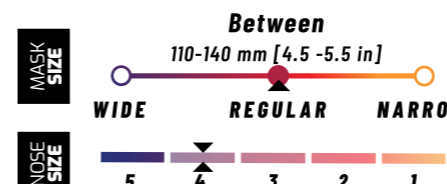

CRESSI'S SIZE CHART IS TO BE USED AS A REFERENCE ONLY
++MEASURE EAR TO EAR WITH A RULER

- U.S. PAT 6272693 B1
- ULTRA LOW VOLUME
- INTEGRATED DUAL FRAME
- TEMPERED GLASS IDF-TECHNOLOGY INTEGRATED DUAL FRAME
- MICROMETRIC ADJUSTABLE BUCKLE
- FLEXIBLE BUCKLE
- TEMPERED GLASS
- 100% HIGH QUALITY SILICONE SKIRT



CALIBRO +

| BUILT WITH THE IDF TECHNOLOGY INTEGRATED DUAL FRAME
| BUCKLE WITH LARGER BUTTON | DOUBLE INJECTION SILICONE STRAP



TECHNICAL FEATURES

- Made with Cressi's patented IDF technology
- Stop Fog system that traps the moisture escaping from the nose reducing drastically the fogging up
- Low internal volume mask
- Adjustable buckles connected with a rubber strip to the frame increasing the comfort
- Inverted teardrop tempered glasses increase the field of view and downwards visibility
- New improved dual strap made of a double injection

DOUBLE INJECTION SILICONE STRAP



Cressi's next generation diving masks are all equipped with the IDF-INTEGRATED DUAL FRAME TECHNOLOGY which offers exceptional field of view, and the new Calibro is no exception. The mask is designed so that the integrated face and frame allow for an extremely hydrodynamic and compact shape and a particularly wide lens, maintaining the mask extremely close to the face. Cressi's Calibro combines minimal internal volume with a phenomenal field of view due to the raked

angle of the frame. The buckles are, as always, directly integrated into the rigid skirt through a solid but flexible rubber attachment that allows you to adjust and place the mouthpiece without shifting the mask. Thanks to its matte coating, the mask's components all match, enhancing the underwater experience since it prevents reflections in the water that may disturb marine life. Calibro is the perfect mask for freediving since it is designed to provide the diver with a feeling of total freedom and comfort.



CODE	COLOR	CASE PACK
DS480020	Clear/Blue Metal	6
DS480040	Clear/Pink	6
DS485020	Black/Blue	6
DS485058	Black/Red	6



INNER NOSE POCKET - NEW PATENT PENDING

A patented membrane surrounding the inner nose pocket which acts as a barrier and traps any moisture escaping from the diver's nose involuntarily when breathing through the mouth. The result is that not only is the moisture channeled away from the lenses, thus avoiding the fogging up of them, but it also reduces the need to compensate for pressure.

To further improve the anti-fog effect, Cressi suggests, the first times that the dive mask is used, to spray some anti-fog solution or to apply some saliva on the inside of the lenses and then to rinse them with water.

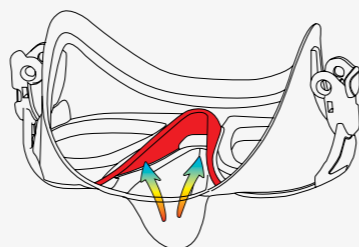

CRESSI PATENTED TECHNOLOGIES

★ INCLINED GLASSES US 6272693 B1

Cressi has developed and patented in 2001 a particular mask frame that to solve the problem of the divers not being able to easily see the scuba equipment. A scuba diver carrying many different pieces of equipment, some of them are vital like the pressure and depth gauges. The solution has been found designing a new frame shape that is inclined downwards. Moreover, the shape of the lens is designed like an inverted teardrop increasing drastically the downward visibility.



★ INTEGRATED BUCKLES US 8281417 B2

The patented technology is to provide a mask for aquatic activities that avoid loss of watertight during strap-tightening by a diver when the mask is in use underwater. The object of the invention is to avoid exertion of a tensile force or stress during mask adjustment and, in turn, rupture of the skirt. The buckles are not directly fixed to the frame but anchored to the rubber of the skirt, allowing it to freely swivel and pivot in all directions. The buckles are joined with lateral sides of the frame by brackets extending from the lateral sides. The brackets are made of a selected flexible material. This features facilitates the mask storage when not in use.

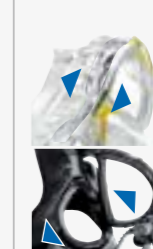

★ INTEGRATED DUAL FRAME US 20140013494 A1

The Patented Integrated Dual Frame Technology consists of the joining of two rigid frames, the first on the rear of the silicone skirt and the second, anterior to the first one, that support the lenses. When the two frames are joined and locked together, the silicone skirt remains locked in the middle to guarantee a perfect seal between the face piece and the lens. This technology produces a drastic reduction in the internal volume, while keeping the lenses close to the eyes to ensure a wide view laterally and in the lower zone. The result is a mask with an extremely hydrodynamic shape and low volume.

SPARE PARTS

CODE	PRODUCT
DZ215009	STRAP LOOP SMALL for PRO DIVE MASKS - CLEAR (PAIR)
DZ215011	STRAP LOOP SMALL for PRO DIVE MASKS - BLACK (PAIR)

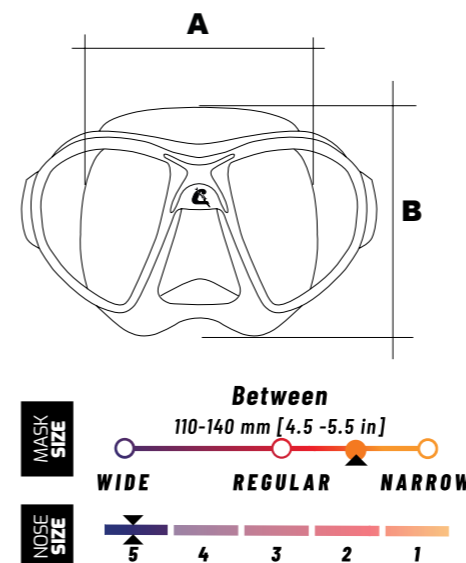

PRODUCT DIMENSION CHART (SKIRT SIZE)

A WIDTH (mm)	B HEIGHT (mm)	A WIDTH (in)	B HEIGHT (in)
112	103	4 7/16	4 1/16

CRESSI'S SIZE CHART IS TO BE USED AS A REFERENCE ONLY

CALIBRO

| BUILT WITH THE FOG STOP SYSTEM



Cressi's next generation diving masks are all equipped with the Integrated Dual Frame Technology which offers exceptional field of view, and the new Calibro is no exception.

The mask is designed so that the integrated face and frame allow for an extremely hydrodynamic and compact shape and a particularly wide lens, maintaining the mask extremely close to the face. Cressi's Calibro combines minimal internal volume with a phenomenal field of view due to the raked angle of the frame.



CODE	COLOR	CASE PACK
DS424030	White/Pink	6
DS425050	Black/Black	6
DS425550	Blue Metal/Black	6
DS426000	Clear/Black	6
DS426050	Black/Black HD Lens	6
DS429850	Green/Green	6

SPARE PARTS

CODE	PRODUCT
DZ215003	SILICONE STRAP - CLEAR for ITALIAN SCUBA MASK
DZ215004	SILICONE STRAP - BLACK for ITALIAN SCUBA MASK
DZ215009	STRAP LOOP SMALL for PRO DIVE MASKS - CLEAR (PAIR)
DZ215011	STRAP LOOP SMALL for PRO DIVE MASKS - BLACK (PAIR)



» Traditional mask



PACKAGING



TECHNICAL FEATURES

- Ultra low volume
- Tempered glass lens
- Micrometric adjustable buckle
- Flexible buckle
- Cressi's Fog-Stop system



HD LENSES

HD MIRRORED LENSES INCREASE THE VISION'S CLEARNESS BY 15%

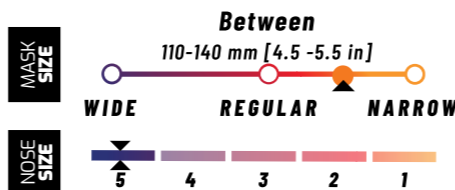
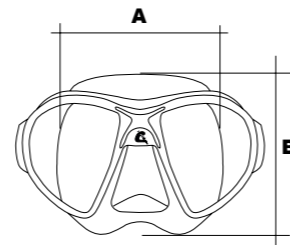

PRODUCT DIMENSION CHART (SKIRT SIZE)

A WIDTH (mm)	B HEIGHT (mm)	A WIDTH (in)	B HEIGHT (in)
112	103	4 7/16	4 1/16

CRESSI'S SIZE CHART IS TO BE USED AS A REFERENCE ONLY



A1

| ANTI-FOG SPECIAL LENS



The A1 has been designed with an attractive style, boasting high performance for scuba diving and freediving. It features a single-lens made of tempered glass with a special sun ray protection to better protect your eyes. The lenses are inclined and they have an inverted teardrop shape, increasing the downward visibility. This allows better control of your scuba diving equipment.

The skirt and the strap are made of a soft silicone ensuring a proper fit for most

shaped faces. The top of the skirt features a double edge for a better seal. The skirt design improves water expulsion during mask clearance and minimizes water pooling. The buckles are connected to the frame with a soft and elastic flap, not only for a flexible fit, but also to reduce drag and the risk of breakage. The buckles allow a quick and immediate adjustment of the strap length with one hand, even while wearing gloves. It features a soft nose pocket for ease of equalization.



CODE	COLOR	CASE PACK
XDN400013	Black/Blue - Clear anti-fog lens	10
XDN400014	Black/Blue - Yellow anti-fog lens	10
XDN400021	Black/Pink - Clear anti-fog lens	10
XDN400022	Black/Pink - Yellow anti-fog lens	10
XDN400057	Black/Graphite - Clear anti-fog lens	10
XDN400058	Black/Graphite - Yellow anti-fog lens	10
XDN400061	White/White - Clear anti-fog lens	10
XDN400062	White/White - Yellow anti-fog lens	10

SPARE PARTS

CODE	PRODUCT
DZ222050	STRAP for SCUBA MASK TW - BLACK
DZ222030	STRAP for SCUBA MASK TW - WHITE
DZ221050	BUCKLES for SCUBA MASK TW - BLACK/BLACK
DZ221030	BUCKLES for SCUBA MASK TW - WHITE/CLEAR

TECHNICAL FEATURES

- Skirt and the strap made of a soft silicone ensuring a proper fit for most facial shapes
- The top of the internal skirt features a double edge that increases drastically the sealing
- The skirt design improves water expulsion during mask clearance and minimizes water pooling
- Soft nose pocket for ease of equalization
- The buckles allow for a quick and immediate adjustment of the strap length with one hand, even while wearing gloves
- Yellow lens increases the contrast, making the objects more visible, and increases the vibrancy of the colors underwater

CLEAR VIEW ON EVERY DIVE! INCLUDING THE FIRST



Cressi's Anti Fog Lens Coating Technology is a new, innovative method to allow the snorkeler or the diver to enjoy the mask right from the beginning. The new Anti Fog lens is possible thanks to an exclusive coating method based on an invisible film that attaches to the lens during the mask production

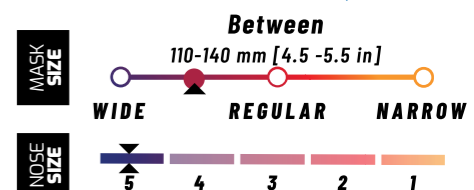

PRODUCT DIMENSION CHART (SKIRT SIZE)

A WIDTH (mm)	B HEIGHT (mm)	A WIDTH (in)	B HEIGHT (in)
130	118	5 2/16	4 10/16

CRESSI'S SIZE CHART IS TO BE USED AS A REFERENCE ONLY
 ++MEASURE EAR TO EAR WITH A RULER

NANO & NANO CRYSTAL®

| 85 CM3: ULTRA LOW VOLUME

- U.S. PAT 6272693 B1
- TEMPERED GLASS
- MICROMETRIC ADJUSTABLE BUCKLE
- FLEXIBLE BUCKLE
- 100% HIGH QUALITY SILICONE SKIRT
- ULTRA LOW VOLUME
- INTEGRATED DUAL FRAME



TECHNICAL FEATURES

- Extremely hydrodynamic and compact design
- Internal volume just 85 cm³
- Reduced lens-face distance
- Angle lenses and slender structure optimize visibility
- Swivel buckles with micrometric adjustment
- Lenses in tempered glass
- Anatomical strap

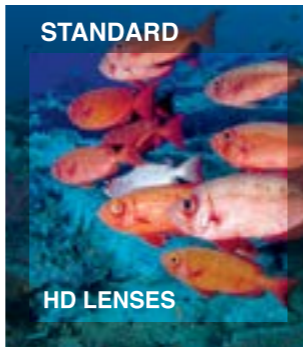

HD MIRRORED LENSES INCREASE THE VISION'S CLEARNESS BY 15%

CRESSI crystal

THE SILICONE REVOLUTION

CRYSTAL silicone® is an exclusive CRESSI material that revolutionizes swim mask skirt clarity.

It offers incredibly clear vision and features long-lasting advanced technology components within the pure silicone skirt which prevents premature discoloration, reduces fogging, and guarantees many years of CRYSTAL clear viewing.

This mask has a particular tapered structure deriving directly from the highly popular Nano-mask patent. The Dual Integrated Frame Technology System joins the silicone skirt to the lens frame without major interruptions of the curvature continuity. The result is a mask with an extremely hydrodynamic shape and a significantly smaller size, with equal visibility. Thanks to the Inclined Lens Patented Technology, the field of view obtained is particularly wide,

laterally and in the lower zone. The skirt, in the front part, has a structural silicone insert which increases the sealing ability of the mask and creates an exceptionally pleasant chromatic play. The Nano is for advanced divers, freediving and spearfishing lovers, designed to offer an extremely hydrodynamic and compact shape to help divers cut through the water and aid movements in small spaces.



CODE	COLOR	CASE PACK
DS360010	Yellow	6
DS360020	Blue	6
DS360040	Pink	6
DS360060	White	6
DS365050	Black/Black	6
DS365550	Blue/Black	6
DS366050	Black/Black, HD Edition	6
DS369850	Green/Green	6



CRESSI PATENTED TECHNOLOGIES

★ INCLINED GLASSES US 6272693 B1

Cressi has developed and patented in 2001 a particular mask frame that to solve the problem of the divers not being able to easily see the scuba equipment. A scuba diver carrying many different pieces of equipment, some of them are vital like the pressure and depth gauges. The solution has been found designing a new frame shape that is inclined downwards. Moreover, the shape of the lens is designed like an inverted teardrop increasing drastically the downward visibility.

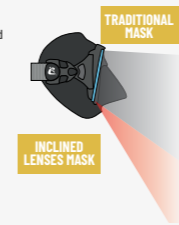

★ INTEGRATED BUCKLES US 8281417 B2

The patented technology is to provide a mask for aquatic activities that avoid loss of watertight during strap-tightening by a diver when the mask is in use underwater. The object of the invention is to avoid exertion of a tensile force or stress during mask adjustment and, in turn, rupture of the skirt. The buckles are not directly fixed to the frame but anchored to the rubber of the skirt, allowing it to freely swivel and pivot in all directions. The buckles are joined with lateral sides of the frame by brackets extending from the lateral sides. The brackets are made of a selected flexible material. This features facilitates the mask storage when not in use.

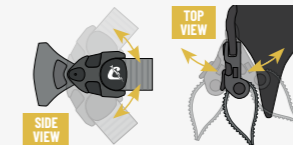

★ INTEGRATED DUAL FRAME US 20140013494 A1

The Patented Integrated Dual Frame Technology consists of the joining of two rigid frames, the first on the rear of the silicone skirt and the second, anterior to the first one, that support the lenses. When the two frames are joined and locked together, the silicone skirt remains locked in the middle to guarantee a perfect seal between the face piece and the lens. This technology produces a drastic reduction in the internal volume, while keeping the lenses close to the eyes to ensure a wide view laterally and in the lower zone. The result is a mask with an extremely hydrodynamic shape and low volume.

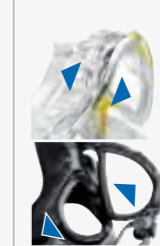

SPARE PARTS

CODE	PRODUCT
DZ215002	SILICONE STRAP - SILVER for CRYSTAL MASKS
DZ215003	SILICONE STRAP - CLEAR for ITALIAN SCUBA MASK
DZ215004	SILICONE STRAP - BLACK for ITALIAN SCUBA MASK
DZ210021	BUCKLES - BLACK for AIR/BIG EYES EVO/EYES EVO/NANO/OCCHIO P.
DZ215009	STRAP LOOP SMALL for PRO DIVE MASKS - CLEAR (PAIR)
DZ215011	STRAP LOOP SMALL for PRO DIVE MASKS - BLACK (PAIR)

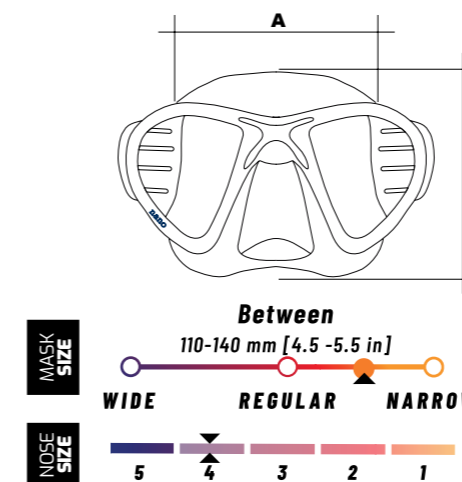

PRODUCT DIMENSION CHART (SKIRT SIZE)			
A WIDTH (mm)	B HEIGHT (mm)	A WIDTH (in)	B HEIGHT (in)
118	104	4 10/16	4 2/16

CRESSI'S SIZE CHART IS TO BE USED AS A REFERENCE ONLY

TEMPERED GLASS | INCLINED LENSES | DOUBLE INJECTION TECHNOLOGY | U.S. PAT 6272693 B1 | MICROMETRIC ADJUSTABLE BUCKLE | 100% HIGH QUALITY SILICONE SKIRT | FLEXIBLE BUCKLE



BIG EYES EVOLUTION CRYSTAL®



TECHNICAL FEATURES

- Extremely hydrodynamic and compact design
- Internal volume just 85 cm³
- Reduced lens-face distance
- Angle lenses and slender structure optimize visibility
- Swivel buckles with micrometric adjustment
- Lenses in tempered glass
- Anatomical strap

CRESSI crystal®

THE SILICONE REVOLUTION

CRYSTAL silicone® is an exclusive CRESSI material that revolutionizes swim mask skirt clarity.

It offers incredibly clear vision and features long-lasting advanced technology components within the pure silicone skirt which prevents premature discoloration, reduces fogging, and guarantees many years of CRYSTAL clear viewing.

OPTICAL LENSES

Possibility of mounting optical lenses
CORRECTION -1.0 > -6.00

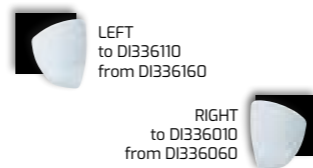

OPTICAL LENSES INSTALLATION \$ 5.00

NOT SYMMETRICAL LENSES

The lenses are positive for correcting negative dioptres (myopia)

COMPLETE INFORMATION

OPTICAL LENSES

Please refer to page 172 chart

The ultimate in comfort and performance, the Big Eyes Evolution Crystal combines the best of Cressi technology.

Raked lenses, with Cressi's inverted tear-drop shape, are placed close to the eyes for an exceptional field of view, and the Crystal Silicone

skirt delivers excellent light transmission while resisting discoloration and fogging. The Crystal Silicone skirt also seals gently against the skin with a very open angle that accommodates a wide range of facial shapes.



CODE	COLOR	CASE PACK
D5340010	Yellow/Black	6
D5340025	Blue/Black	6
D5340040	White/Pink	6
D5340060	Clear/Black	6
D5340062	White/Blue	6



CRESSI PATENTED TECHNOLOGIES

★ INCLINED GLASSES US 6272693 B1

Cressi has developed and patented in 2001 a particular mask frame that to solve the problem of the divers not being able to easily see the scuba equipment. A scuba diver carrying many different pieces of equipment some of them are vital like the pressure and depth gauges. The solution has been found designing a new frame shape that is inclined downwards. Moreover, the shape of the lens is designed like an inverted teardrop increasing drastically the downward visibility.

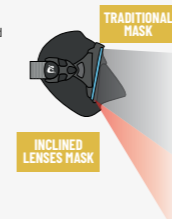

★ INTEGRATED BUCKLES US 8281417 B2

The patented technology is to provide a mask for aquatic activities that avoid loss of watertight during strap-tightening by a diver when the mask is in use underwater. The object of the invention is to avoid exertion of a tensile force or stress during mask adjustment and, in turn, rupture of the skirt. The buckles are not directly fixed to the frame but anchored to the rubber of the skirt, allowing it to freely swivel and pivot in all directions. The buckles are joined with lateral sides of the frame by brackets extending from the lateral sides. The brackets are made of a selected flexible material. This features facilitates the mask storage when not in use.

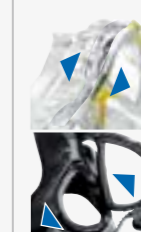

★ INTEGRATED DUAL FRAME US 20140013494 A1

The Patented Integrated Dual Frame Technology consists of the joining of two rigid frames, the first on the rear of the silicone skirt and the second, anterior to the first one, that support the lenses. When the two frames are joined and locked together, the silicone skirt remains locked in the middle to guarantee a perfect seal between the face piece and the lens. This technology produces a drastic reduction in the internal volume, while keeping the lenses close to the eyes to ensure a wide view laterally and in the lower zone. The result is a mask with an extremely hydrodynamic shape and low volume.

SPARE PARTS

CODE	PRODUCT
DZ215003	SILICONE STRAP - CLEAR for ITALIAN SCUBA MASK
DZ215004	SILICONE STRAP - BLACK for ITALIAN SCUBA MASK
DZ210021	BUCKLES - BLACK for AIR/BIG EYES EVO/EYES EVO/NANO/OCCHIO P.
DZ215009	STRAP LOOP SMALL for PRO DIVE MASKS - CLEAR (PAIR)
DZ215011	STRAP LOOP SMALL for PRO DIVE MASKS - BLACK (PAIR)

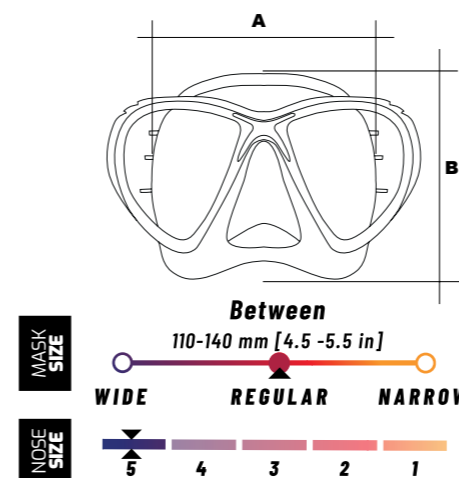

PRODUCT DIMENSION CHART (SKIRT SIZE)			
A WIDTH (mm)	B HEIGHT (mm)	A WIDTH (in)	B HEIGHT (in)
124	110	4 14/16	4 5/16

CRESSI'S SIZE CHART IS TO BE USED AS A REFERENCE ONLY

- TEMPERED GLASS
- INCLINED LENSES
- DOUBLE INJECTION TECHNOLOGY
- U.S. PAT 6272693 B1
- MICROMETRIC ADJUSTABLE BUCKLE
- 100% HIGH QUALITY SILICONE SKIRT
- FLEXIBLE BUCKLE

EYES EVOLUTION CRYSTAL®



The Eyes Evolution Crystal comes with all of the great features of the Big Eyes Evolution Crystal, but in a smaller size that makes it ideal for women and smaller faces. The Crystal Silicone is an exclusive Cressi material that's

so clear the mask's skirt is virtually invisible when diving. The thickness of the mask frame has been reduced to such an extent that it is practically invisible when the mask is being worn.



CODE	COLOR	CASE PACK
DS350010	Yellow	6
DS350020	Blue	6
DS350040	Pink	6
DS350060	Black	6
DS350050	Black/Black	6

SPARE PARTS

CODE	PRODUCT
DZ215002	SILICONE STRAP - SILVER for CRYSTAL MASKS
DZ210021	BUCKLES - BLACK for AIR/BIG EYES EVO/EYES EVO/NANO/OCCHIO P.
DZ215009	STRAP LOOP SMALL for PRO DIVE MASKS - CLEAR (PAIR)

CRESSI PATENTED TECHNOLOGIES

- ★ INCLINED GLASSES US 6272693 B1
- ★ INTEGRATED BUCKLES US 8281417 B2
- ★ INTEGRATED DUAL FRAME US 20140013494 A1



TECHNICAL FEATURES

- Flexible buckle
- Designed for those with a narrow or small face

CRESSI crystal®

THE SILICONE REVOLUTION

CRYSTAL silicone® is an exclusive CRESSI material that revolutionizes swim mask skirt clarity.

It offers incredibly clear vision and features long-lasting advanced technology components within the pure silicone skirt which prevents premature discoloration, reduces fogging, and guarantees many years of CRYSTAL clear viewing.

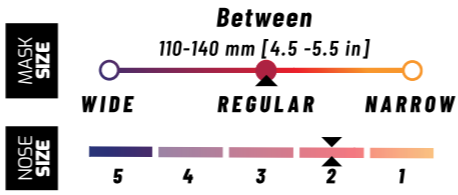
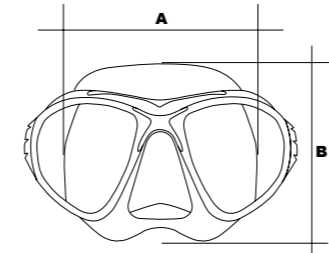

PRODUCT DIMENSION CHART (SKIRT SIZE)

A WIDTH (mm)	B HEIGHT (mm)	A WIDTH (in)	B HEIGHT (in)
114	106	4 8/16	4 3/16

CRESSI'S SIZE CHART IS TO BE USED AS A REFERENCE ONLY



- TEMPERED GLASS
- INCLINED LENSES
- DOUBLE INJECTION TECHNOLOGY
- U.S. PAT 6272693 B1
- MICROMETRIC ADJUSTABLE BUCKLE
- 100% HIGH QUALITY SILICONE SKIRT
- FLEXIBLE BUCKLE

BIG EYES EVOLUTION

The Big Eyes Evolution's signature inverted tear-drop lenses are raked inward and provide outstanding field of view with very low internal volume. A redesigned skirt now uses internal ribs to provide the ultimate in fit and support. Fully flexible, easy to adjust buckles are attached using Cressi's double injection molding technology for both comfort and extreme durability.



TECHNICAL FEATURES

- Double injection technology
- Raked lenses provide excellent field-of-view low internal volume allows for effortless clearing dual-density silicone skirt flexes for a perfect seal along the face and full support around the frame.

OPTICAL LENSES

Possibility of mounting optical lenses CORRECTION -1.0 > -6.00

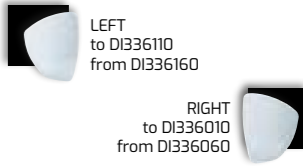

OPTICAL LENSES INSTALLATION \$ 5.00

NOT SYMMETRICAL LENSES

The lenses are positive for correcting negative dioptres (myopia)

COMPLETE INFORMATION

OPTICAL LENSES Please refer to page 172 chart



CODE	COLOR	CASE PACK
DS336010	Clear/Yellow	6
DS336020	Clear/Blue	6
DS336040	Clear/Pink	6
DS336060	Clear/Black	6
DS336080	Clear/Red	6
DS336510	Black/Yellow	6
DS336520	Black/Blue	6
DS336550	Black/Black	6
DS336950	Black/Black, HD Edition	6

SPARE PARTS

CODE	PRODUCT
DZ215003	SILICONE STRAP - CLEAR for ITALIAN SCUBA MASK
DZ215004	SILICONE STRAP - BLACK for ITALIAN SCUBA MASK
DZ210021	BUCKLES - BLACK for AIR/BIG EYES EVO/EYES EVO/NANO/OCCHIO P.
DZ215009	STRAP LOOP SMALL for PRO DIVE MASKS - CLEAR (PAIR)
DZ215011	STRAP LOOP SMALL for PRO DIVE MASKS - BLACK (PAIR)

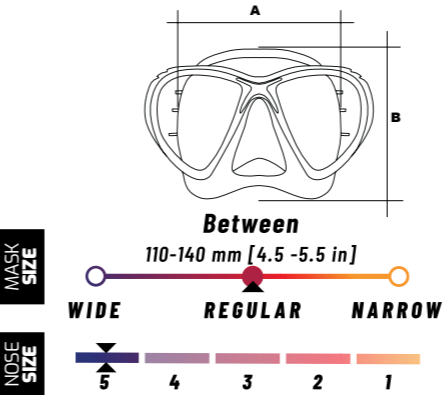

PRODUCT DIMENSION CHART (SKIRT SIZE)

A WIDTH (mm)	B HEIGHT (mm)	A WIDTH (in)	B HEIGHT (in)
124	110	4 14/16	4 5/16

CRESSI'S SIZE CHART IS TO BE USED AS A REFERENCE ONLY



HD MIRRORED LENSES INCREASE THE VISION'S CLARITY BY 15%

- U.S. PAT 6272693 B1
- IDF-TECHNOLOGY INTEGRATED DUAL FRAME
- MICROMETRIC ADJUSTABLE BUCKLE
- DOUBLE INJECTION TECHNOLOGY
- INCLINED LENSES
- 100% HIGH QUALITY SILICONE SKIRT
- FLEXIBLE BUCKLE
- TEMPERED GLASS



AIR CRYSTAL® & AIR



This mask has a particular tapered structure deriving directly from the highly popular Nano-mask patent. The Dual Integrated Frame Technology System joins the silicone skirt to the lens frame without major interruptions of the curvature continuity. The result is a mask with an extremely hydrodynamic shape and a significantly smaller size, with

equal visibility. Thanks to the Inclined Lens Patented Technology, the field of view obtained is particularly wide, laterally and in the lower zone. The skirt, in the front part, has a structural silicone insert which increases the sealing ability of the mask and creates an exceptionally pleasant chromatic play. Micrometer adjustable buckles.



CODE	COLOR	CASE PACK
DS400020	Blue/White	6
DS400041	Lilac/Black	6
DS400060	White/Black	6
DS400062	Blue/Black	6
DS405010	Black/Yellow	6
DS405050	Black/Black	6
DS405062	Black/Blue	6
DS405550	Blue Metal	6

TECHNICAL FEATURES

- Double injection technology
- Flexible buckle

CRESSI crystal

THE SILICONE REVOLUTION

CRYSTAL silicone® is an exclusive CRESSI material that revolutionizes swim mask skirt clarity.

It offers incredibly clear vision and features long-lasting advanced technology components within the pure silicone skirt which prevents premature discoloration, reduces fogging, and guarantees many years of CRYSTAL clear viewing.

The Air mask has a particular tapered structure deriving directly from the highly popular Nano-mask patent. The Dual Integrated Frame Technology System joins the silicone skirt to the lens frame without major interruptions of the curvature continuity. The result is a mask with an extremely hydrodynamic shape and a significantly smaller size, with equal visibility. Thanks to the Inclined Lens Patented Technology, the field of view obtained is particularly wide, laterally and in the lower zone. The skirt, in the front part, has a structural silicone insert which increases the sealing ability of the mask and creates an exceptionally pleasant chromatic play. Micrometer adjustable buckles.



CRESSI PATENTED TECHNOLOGIES

★ INCLINED GLASSES US 6272693 B1

Cressi has developed and patented in 2001 a particular mask frame that to solve the problem of the divers not being able to easily see the scuba equipment. A scuba diver carrying many different pieces of equipment, some of them are vital like the pressure and depth gauges. The solution has been found designing a new frame shape that is inclined downwards. Moreover, the shape of the lens is designed like an inverted teardrop increasing drastically the downward visibility.

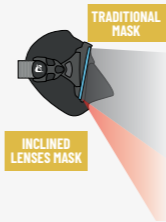

★ INTEGRATED BUCKLES US 8281417 B2

The patented technology is to provide a mask for aquatic activities that avoid loss of watertight during strap-tightening by a diver when the mask is in use underwater. The object of the invention is to avoid exertion of a tensile force or stress during mask adjustment and, in turn, rupture of the skirt. The buckles are not directly fixed to the frame but anchored to the rubber of the skirt, allowing it to freely swivel and pivot in all directions. The buckles are joined with lateral sides of the frame by brackets extending from the lateral sides. The brackets are made of a selected flexible material. This features facilitates the mask storage when not in use.

★ INTEGRATED DUAL FRAME US 20140013494 A1

The Patented Integrated Dual Frame Technology consists of the joining of two rigid frames, the first on the rear of the silicone skirt and the second, anterior to the first one, that support the lenses. When the two frames are joined and locked together, the silicone skirt remains locked in the middle to guarantee a perfect seal between the face piece and the lens. This technology produces a drastic reduction in the internal volume, while keeping the lenses close to the eyes to ensure a wide view laterally and in the lower zone. The result is a mask with an extremely hydrodynamic shape and low volume.

SPARE PARTS

CODE	PRODUCT
DZ215002	SILICONE STRAP - SILVER for CRYSTAL MASKS
DZ210021	BUCKLES - BLACK for AIR/BIG EYES EVO/EYES EVO/NANO/OCCHIO P.
DZ215009	STRAP LOOP SMALL for PRO DIVE MASKS - CLEAR (PAIR)

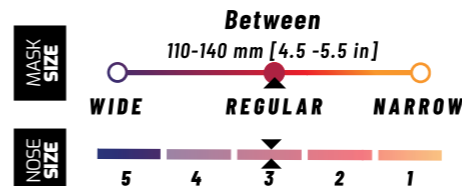
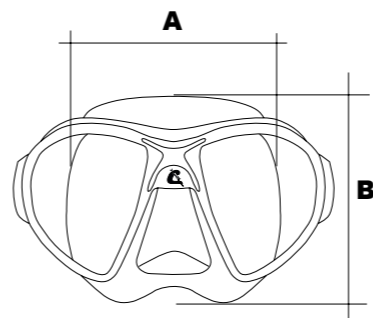

PRODUCT DIMENSION CHART (SKIRT SIZE)

A WIDTH (mm)	B HEIGHT (mm)	A WIDTH (in)	B HEIGHT (in)
115	110	4 9/16	4 5/16

CRESSI'S SIZE CHART IS TO BE USED AS A REFERENCE ONLY

- FRAMELESS TECHNOLOGY CRESSI
- MICROMETRIC ADJUSTABLE BUCKLE
- TEMPERED GLASS
- HIGH QUALITY HYPOALLERGENIC SILICONE
- 100% HIGH QUALITY SILICONE SKIRT
- SOFT NOSE POCKET

SF1

| SQUARED FRAMELESS DIVE MASK



The SF1 is the new 2020 Cressi's frameless scuba diving mask for ladies and men. The frameless masks are loved by many divers for their low-profile and ability to fold flat for easy carrying, even in a BC pocket. The silicone face is assembled directly on the glass without mounting. This system guarantees good visibility in all directions, especially towards the sides, since it allows

a maximum eye/lens approach without annoying pressure on the forehead or upper part of the nose.

The low-internal volume allows for effortless clearing and quick-adjust strap buckles are molded directly into the skirt for a flexible fit and reduced drag. It also represents an unbeatable value, with a cost roughly half that of similar masks.



CODE	COLOR	CASE PACK
ZDN331000	Clear	30
ZDN331020	Blue	30
ZDN331051	Titanium	30
ZDN331058	Red	30
ZDN332000	Black	30
ZDN333000	White	30

SPARE PARTS

CODE	PRODUCT
DZ222020	STRAP for SCUBA MASK TW - BLUE
DZ222030	STRAP for SCUBA MASK TW - WHITE
DZ222050	STRAP for SCUBA MASK TW - BLACK
DZ222051	STRAP for SCUBA MASK TW - SILVER
DZ222080	STRAP for SCUBA MASK TW - RED
DZ221030	BUCKLES for SCUBA MASK TW - WHITE/CLEAR
DZ221050	BUCKLES for SCUBA MASK TW - BLACK/BLACK
DZ215014	STRAP LOOP for SCUBA MASK TW - CLEAR (PAIR)



TECHNICAL FEATURES

- Cressi frameless technology
- Micrometric adjustable buckle
- Tempered glass
- Ultra low-volume, single lens design for excellent field-of-view
- Silicone skirt bonds directly to the lens for lower weight and reduced drag
- Quick adjustable buckles mounted on the skirt
- High-quality flexible silicone that gently and securely adheres to the face

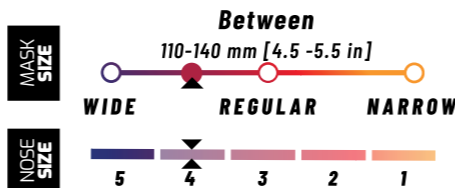
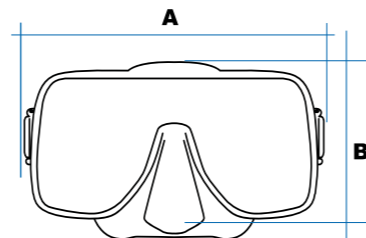

PRODUCT DIMENSION CHART (SKIRT SIZE)

A WIDTH (mm)	B HEIGHT (mm)	A WIDTH (in)	B HEIGHT (in)
129	107	5 1/16	4 3/16

++MEASURE EAR TO EAR WITH A RULER



F-DUAL

| SQUARED FRAMELESS DIVE MASK



TECHNICAL FEATURES

- Frameless technology for maximum comfort
- Single tempered glass lens
- Wide field of view
- High-grade soft silicone
- Double feathered edge skirt
- Quick-adjustable strap buckles
- Easy-access nose pocket for 1-handed ear equalization the face



Single-lens mask featuring a unique assembly of lens and skirt without a frame. Cressi's F-Dual Mask Design Bonds a High-Grade Silicone Double Feathered Edge Skirt directly to a Single Tempered Glass Lens for the Ultimate in Simplicity.

Colorful Frameless technology. The silicone facial is assembled directly on the glass without the need for a frame. This system guarantees good visibility in all directions.

The Low Internal Volume allows for effortless clearing and the Quick-Adjust Strap Buckles are molded directly into the Skirt for a Flexible Fit and Reduced Drag. The Cressi F-Dual Mask has a Wide Split Mask Strap Design for Comfort and to give Even-Tension on the Skirt for a Proper Seal.

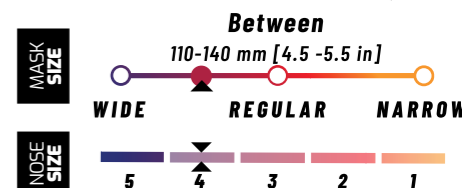
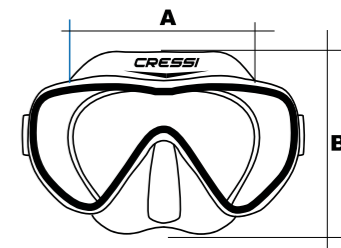

CODE	COLOR	CASE PACK
D5500010	Clear/Yellow	30
D5500020	Clear/Blue	30
D5500050	Clear/Black	30
D5503040	White/Pink	30
D5505020	Black/Blue	30
D5505030	Black/White	30
D5505080	Black/Red	30

SPARE PARTS

CODE	PRODUCT
DZ222000	STRAP for SCUBA MASK TW - CLEAR
DZ222050	STRAP for SCUBA MASK TW - BLACK
DZ221030	BUCKLES for SCUBA MASK TW - WHITE/CLEAR
DZ221050	BUCKLES for SCUBA MASK TW - BLACK/BLACK
DZ215014	STRAP LOOP for SCUBA MASK TW - CLEAR (PAIR)

PRODUCT DIMENSION CHART (SKIRT SIZE)

A WIDTH (mm)	B HEIGHT (mm)	A WIDTH (in)	B HEIGHT (in)
130	104	5 2/16	4 2/16

CRESSI'S SIZE CHART IS TO BE USED AS A REFERENCE ONLY
++MEASURE EAR TO EAR WITH A RULER



- FRAMELESS TECHNOLOGY CRESSI
- MICROMETRIC ADJUSTABLE BUCKLE
- TEMPERED GLASS
- 100% HIGH QUALITY SILICONE SKIRT

Z1

| LOW VOLUME FRAMELESS MASK



Z1 is a frameless mask that boasts a low internal volume while offering a wide field of view in all directions.

The specific design uses the assembly of the silicone skirt directly over the single glass. This system guarantees great sturdiness and

a perfect watertight seal. The lower weight of the mask makes it ideal for travel. The flexible fit and reduced drag are appreciated for freediving and spearfishing, snorkeling and diving. The micrometrically adjustable buckles are comfortable and effective.



CODE	COLOR	CASE PACK
DN410000	Clear/Clear	30
DN410020	Blue/Blue	30
DN410050	Black/Black	30
DN410057	Graphite/Graphite	30
DN410080	Red/Red	30

SPARE PARTS

CODE	PRODUCT
DZ222020	STRAP for SCUBA MASK TW - BLUE
DZ222030	STRAP for SCUBA MASK TW - WHITE
DZ222050	STRAP for SCUBA MASK TW - BLACK
DZ222072	STRAP for SCUBA MASK TW - TITANIUM
DZ222080	STRAP for SCUBA MASK TW - RED
DZ221050	BUCKLES for SCUBA MASK TW - BLACK/BLACK
DZ215014	STRAP LOOP for SCUBA MASK TW - CLEAR (PAIR)



TECHNICAL FEATURES

- Low-volume, single lens design for a wide field-of-view
- Frameless:** silicone skirt bonds directly to the lens for lower weight and reduced drag
- Fast-adjust ratcheting strap buckles mounted to skirt
- High-grade silicone seals
- Tempered glass lens
- Easy-access nose pocket for equalization

- » Push-Button Swiveling Buckles
- » TEMPERED GLASS

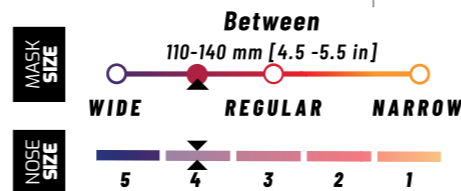
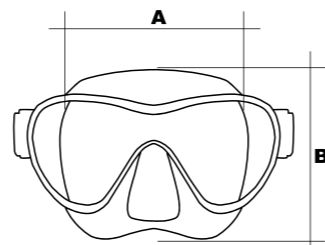

PRODUCT DIMENSION CHART (SKIRT SIZE)

A WIDTH (mm)	B HEIGHT (mm)	A WIDTH (in)	B HEIGHT (in)
122	101	4 13/16	4

CRESSI'S SIZE CHART IS TO BE USED AS A REFERENCE ONLY
 ++MEASURE EAR TO EAR WITH A RULER



PACKAGING



- FOR ADULTS WITH A SMALL FACE
- FRAMELESS TECHNOLOGY CRESSI
- MICROMETRIC ADJUSTABLE BUCKLE
- TEMPERED GLASS
- 100% HIGH QUALITY SILICONE SKIRT

ZS1

NEW 2022

| SMALLER VERSION OF Z1 MASK



ZS1 is the Small version, suitable for adults with small faces, of the Z1, a frameless mask that boasts a low internal volume while offering a wide field of view in all directions. The specific design uses the assembly of the silicone skirt directly over the single glass. This system guarantees great sturdiness and a perfect watertight seal.

The lower weight of the mask makes it ideal for travel. The flexible fit and reduced drag are appreciated for freediving and spearfishing, snorkeling and diving. The micrometrically adjustable buckles are comfortable and effective.



CODE	COLOR	CASE PACK
DN420000	Clear/Clear	30
DN422828	Turquoise/Turquoise	30
DN423030	White/White	30
DN424545	Pink Fluo/Pink Fluo	30
DN425050	Black/Black	30

SPARE PARTS

CODE	PRODUCT
DZ222020	STRAP for SCUBA MASK TW - BLUE
DZ222030	STRAP for SCUBA MASK TW - WHITE
DZ222050	STRAP for SCUBA MASK TW - BLACK
DZ222072	STRAP for SCUBA MASK TW - TITANIUM
DZ222080	STRAP for SCUBA MASK TW - RED
DZ221050	BUCKLES for SCUBA MASK TW - BLACK/BLACK
DZ215014	STRAP LOOP for SCUBA MASK TW - CLEAR (PAIR)

TECHNICAL FEATURES

- Low-volume, single lens design for a wide field-of-view
- Frameless:** silicone skirt bonds directly to the lens for lower weight and reduced drag
- Fast-adjust ratcheting strap buckles mounted to skirt
- High-grade silicone seals
- Tempered glass lens
- Easy-access nose pocket for equalization

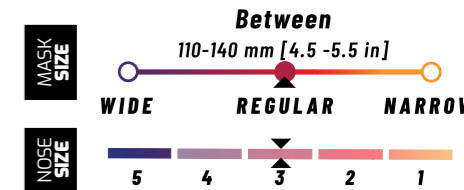
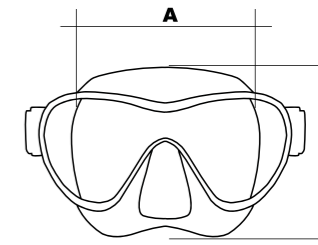

PRODUCT DIMENSION CHART (SKIRT SIZE)

A WIDTH (mm)	B HEIGHT (mm)	A WIDTH (in)	B HEIGHT (in)
119	96	4 11/16	3 12/16

CRESSI'S SIZE CHART IS TO BE USED AS A REFERENCE ONLY
 ++MEASURE EAR TO EAR WITH A RULER



PACKAGING

LIBERTY SPE

- TEMPERED GLASS
- MICROMETRIC ADJUSTABLE BUCKLE
- FLEXIBLE BUCKLE
- 100% HIGH QUALITY SILICONE SKIRT



This airbrush technique blends two colors in a gradation design around the mask frame. The effect is a truly unique and visually stunning matte color incorporated with a top-of-the-line dive mask.

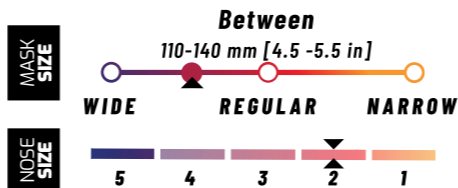
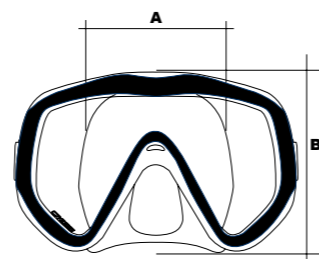

Cressi's Liberty mask offers divers freedom with a phenomenal field of vision in a single lens scuba mask. The exclusive painted, coated frame brings a cool tech design style. Along with the soft silicone skirt and strap, the tempered glass and the easy adjustable buckles, the Liberty is the easy-to-use mask for divers.

freedom with a phenomenal field of vision in a single lens scuba mask. The exclusive painted, coated frame brings a cool tech design style. Along with the soft silicone skirt and strap, the tempered glass and the easy adjustable buckles, the Liberty is the easy-to-use mask for divers.



CODE	COLOR	CASE PACK
D5390020	Clear/Blue	30
D5390050	Clear/Black	30
D5395020	Black/Blue	30
D5395050	Black/Black	30
D5395550	Black/Black, Anti-Fog Lens	30

SPARE PARTS

CODE	PRODUCT
DZ222000	STRAP for SCUBA MASK TW - CLEAR
DZ222050	STRAP for SCUBA MASK TW - BLACK
DZ221030	BUCKLES for SCUBA MASK TW - WHITE/CLEAR
DZ221050	BUCKLES for SCUBA MASK TW - BLACK/BLACK
DZ215012	STRAP LOOP for SCUBA MASK TW - BLACK (PAIR)
DZ215014	STRAP LOOP for SCUBA MASK TW - CLEAR (PAIR)



PRODUCT DIMENSION CHART (SKIRT SIZE)

A WIDTH (mm)	B HEIGHT (mm)	A WIDTH (in)	B HEIGHT (in)
125	135	15/16	5 5/16

CRESSI'S SIZE CHART IS TO BE USED AS A REFERENCE ONLY



PACKAGING

LIBERTY DUO SPE

- TEMPERED GLASS
- MICROMETRIC ADJUSTABLE BUCKLE
- FLEXIBLE BUCKLE
- 100% HIGH QUALITY SILICONE SKIRT



This airbrush technique blends two colors in a gradation design around the mask frame. The effect is a truly unique and visually stunning matte color incorporated with a top-of-the-line dive mask.

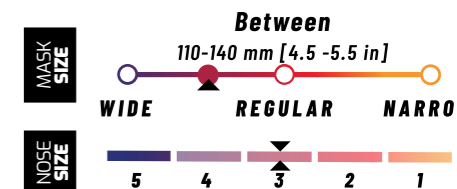
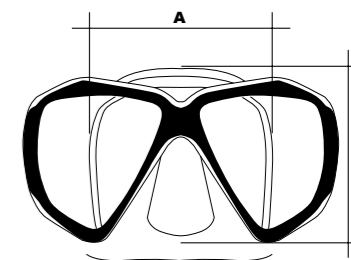

The Liberty Duo features 2 big inverted teardrop lenses to ensure a complete view of equipment. The originality of the mask lies in the skirt's design, which is made to fit every facial profile. The skirt is made in hypoallergenic silicone to ensure comfort

and a perfect seal. It is a breeze to adjust the length of the strap thanks to the two buttons on the buckle, which can also be used while wearing gloves. The variety of colors is a great option to coordinate the mask with the equipment.



CODE	COLOR	CASE PACK
D5440025	Clear/Blue/Silver	10
D5440051	Clear/Black/Silver	10
D5445020	Black/Blue/Blue	10
D5445025	Black/Blue/Silver	10
D5445050	Black/Black/Black	10
D5445051	Black/Black/Silver	10
D5445150	Black/Black/Black, Anti-Fog Lens	10

SPARE PARTS

CODE	PRODUCT
DZ222000	STRAP for SCUBA MASK TW - CLEAR
DZ222050	STRAP for SCUBA MASK TW - BLACK
DZ221030	BUCKLES for SCUBA MASK TW - WHITE/CLEAR
DZ221050	BUCKLES for SCUBA MASK TW - BLACK/BLACK
DZ215012	STRAP LOOP for SCUBA MASK TW - BLACK (PAIR)
DZ215014	STRAP LOOP for SCUBA MASK TW - CLEAR (PAIR)



PRODUCT DIMENSION CHART (SKIRT SIZE)

A WIDTH (mm)	B HEIGHT (mm)	A WIDTH (in)	B HEIGHT (in)
125	108	15/16	4 4/16

CRESSI'S SIZE CHART IS TO BE USED AS A REFERENCE ONLY



PACKAGING

- TEMPERED GLASS
- MICROMETRIC ADJUSTABLE BUCKLE
- FLEXIBLE BUCKLE
- 100% HIGH QUALITY SILICONE SKIRT

LIBERTY TRISIDE SPE



TECHNICAL FEATURES

- 3 lens panoramic design
- Tempered glass
- Micrometric adjustable buckle
- Flexible buckle



This airbrush technique blends two colors in a gradation design around the mask frame. The effect is a truly unique and visually stunning matte color incorporated with a top-of-the-line dive mask.

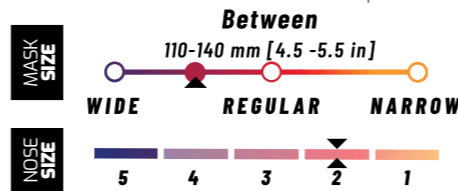
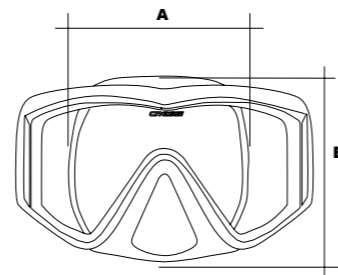

The Liberty Triside features a wide mono front lens with 2-sided lenses to ensure a panoramic view without interruption. The result is a mask that allows maximum light and feels as open as the ocean itself. All lenses are tempered glass for the best clarity. The skirt is made in hypoallergenic silicone

to ensure comfort and a perfect seal. It is a breeze to adjust the length of the strap thanks to the two buttons on the buckle, which can also be used while wearing gloves. The frame is colored with a paint effect that makes the mask elegant and beautiful to see, which can be coordinated with your equipment.



CODE	COLOR	CASE PACK
DS450011	Clear/Gold	32.35
DS450027	Clear/Sapphire	32.35
DS450043	Clear/Rose Gem	32.35
DS455010	Black/Gold	32.35
DS455020	Black/Sapphire	32.35
DS455040	Black/Rose Gem	32.35
DS455050	Black/Graphite	32.35

SPARE PARTS

CODE	PRODUCT
DZ222000	STRAP for SCUBA MASK TW - CLEAR
DZ222050	STRAP for SCUBA MASK TW - BLACK
DZ221030	BUCKLES for SCUBA MASK TW - WHITE/CLEAR
DZ221050	BUCKLES for SCUBA MASK TW - BLACK/BLACK
DZ215012	STRAP LOOP for SCUBA MASK TW - BLACK (PAIR)
DZ215014	STRAP LOOP for SCUBA MASK TW - CLEAR (PAIR)



PRODUCT DIMENSION CHART (SKIRT SIZE)

A WIDTH (mm)	B HEIGHT (mm)	A WIDTH (in)	B HEIGHT (in)
130	118	5 2/16	4 10/16

CRESSI'S SIZE CHART IS TO BE USED AS A REFERENCE ONLY



PACKAGING

- TEMPERED GLASS
- MICROMETRIC ADJUSTABLE BUCKLE
- FLEXIBLE BUCKLE
- 100% HIGH QUALITY SILICONE SKIRT

LIBERTY QUATTRO SPE



TECHNICAL FEATURES

- 4-window mask made with Tempered Glass
- Skirt & Strap made in 100% Silicone combined for Perfect Fit and Seal on Face.
- Spray Painted Effect colored frame that makes the mask elegant and beautiful to see.



This airbrush technique blends two colors in a gradation design around the mask frame. The effect is a truly unique and visually stunning matte color incorporated with a top-of-the-line dive mask.

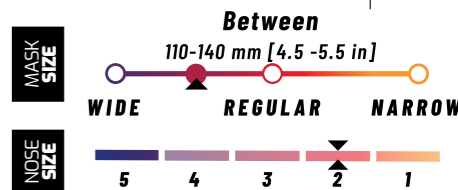
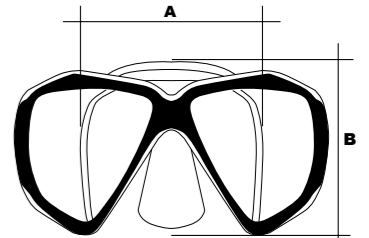

The Liberty Quattro has the characteristics of guaranteeing a panoramic view thanks to the four window panels. The two side lenses are joined and adjoined with the front lenses to guarantee an uninterrupted view. All lenses are tempered glass for the best clarity. The skirt is made in hypoallergenic silicone to

ensure comfort and a perfect seal. It is a breeze to adjust the length of the strap thanks to the two buttons on the buckle, which can also be used while wearing gloves. The frame is colored with a paint effect that makes the mask elegant and beautiful to see, which can be coordinated with your equipment.



CODE	COLOR	CASE PACK
DS460015	Clear-Gold/Silver	10
DS465050	Black/Graphite	10

SPARE PARTS

CODE	PRODUCT
DZ222000	STRAP for SCUBA MASK TW - CLEAR
DZ222050	STRAP for SCUBA MASK TW - BLACK
DZ221030	BUCKLES for SCUBA MASK TW - WHITE/CLEAR
DZ221050	BUCKLES for SCUBA MASK TW - BLACK/BLACK
DZ215012	STRAP LOOP for SCUBA MASK TW - BLACK (PAIR)
DZ215014	STRAP LOOP for SCUBA MASK TW - CLEAR (PAIR)



PRODUCT DIMENSION CHART (SKIRT SIZE)

A WIDTH (mm)	B HEIGHT (mm)	A WIDTH (in)	B HEIGHT (in)
125	115	5 1/16	4 8/16

CRESSI'S SIZE CHART IS TO BE USED AS A REFERENCE ONLY



PACKAGING

PENTA+



The Penta+ is the restyling of the popular Penta mask. It has four lenses and also introduces to this sector all the exceptional characteristics of the Matrix and the Lince. The Cressi patented system of raked lenses with an "inverted drop" shape offers incredible downward visibility, ideal for having under control the scuba diving equipment. The clear side windows are made of scratch-resistant material, more strong than glass or polycarbonate. Thanks to them, the mask

offers unprecedented lateral visibility and great luminosity for total vision with no compromises. The skirt and the strap are made of hypoallergenic silicone, a very soft material compared to the low-quality PVC, that ensures a perfect seal and comfort. The buckles are embedded in the frame to offer instant adjustment of the strap length, even with one hand. It offers a very low internal volume, a record weight of only 175 g (6.2 oz).



CLEAR/BLUE CLEAR/PINK BLACK/BLUE BLACK/BLACK

CODE	COLOR	CASE PACK
DS490020	Clear/Blue	6
DS490040	Clear/Pink	6
DS495020	Black/Blue	6
DS495050	Black/Black	6

TECHNICAL FEATURES

- Four-lens mask
- **Front lenses:** inverted teardrop design to ensure maximum visibility, made of tempered glass
- **Strap buckles:** pressure, with instant adjustment
- Very low internal volume
- Silicone skirt and double strap
- **Weight:** 175 g | 6.2 oz

DOUBLE INJECTION SILICONE STRAP

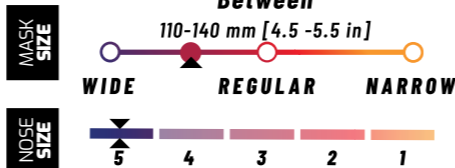
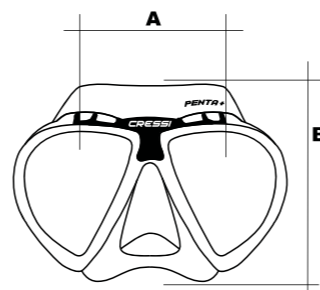

PRODUCT DIMENSION CHART (SKIRT SIZE)

A WIDTH (mm)	B HEIGHT (mm)	A WIDTH (in)	B HEIGHT (in)
128	112	5 1/16	4 7/16

CRESSI'S SIZE CHART IS TO BE USED AS A REFERENCE ONLY
 ++MEASURE EAR TO EAR WITH A RULER



PACKAGING

MATRIX

- U.S. PAT 6272693 B1
- INCLINED LENSES
- MICROMETRIC ADJUSTABLE BUCKLE
- 100% HIGH QUALITY SILICONE SKIRT
- TEMPERED GLASS



The compact twin-lens Matrix takes the basic design concepts of the Big Eyes Evolution and pushes them to a new level of performance.

More pronounced inverted tear-drop shaped

lenses, raked inward to sit even closer to the eyes, and a more compact build overall make the Matrix an ideal choice for divers and freedivers looking for the biggest view in the smallest package.



CLEAR/YELLOW CLEAR/BLUE CLEAR/BLACK BLACK/BLACK GREEN/BLACK

CODE	COLOR	CASE PACK
DS301010	Clear/Yellow	6
DS301020	Clear/Blue	6
DS301060	Clear/Clear	6
DS302050	Black/Black	6
DS309850	Green/Black	6

SPARE PARTS

CODE	PRODUCT
DZ215003	SILICONE STRAP - CLEAR for ITALIAN SCUBA MASK
DZ215004	SILICONE STRAP - BLACK for ITALIAN SCUBA MASK
DZ210018	BUCKLES - BLACK for MATRIX/LINCE/PENTA
DZ215009	STRAP LOOP SMALL for PRO DIVE MASKS - CLEAR (PAIR)
DZ215011	STRAP LOOP SMALL for PRO DIVE MASKS - BLACK (PAIR)
DZ400001	SIDE FRAME CLIPS for MATRIX MASK

CRESSI PATENTED TECHNOLOGIES

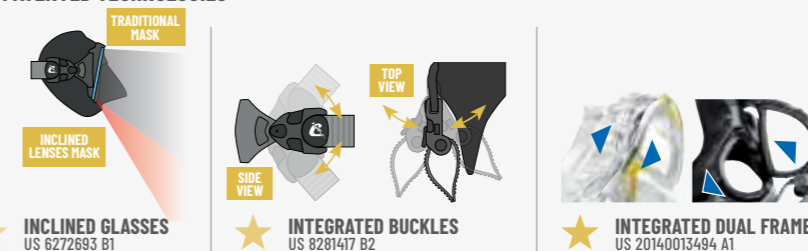

★ INCLINED GLASSES US 6272693 B1

★ INTEGRATED BUCKLES US 8281417 B2

★ INTEGRATED DUAL FRAME US 2014/0013494 A1

TECHNICAL FEATURES

- Raked lenses provide excellent field-of-view
- Extremely low internal volume on par with the best freediving masks
- Silicone skirt shaped to provide a wide sealing surface for a leak-free fit
- Micrometric adjustable buckles allow precise headband adjustments
- Inverted tear-drop lenses improve downward vision for viewing your BCD while diving

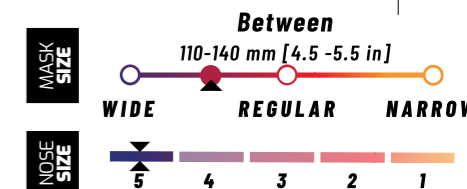
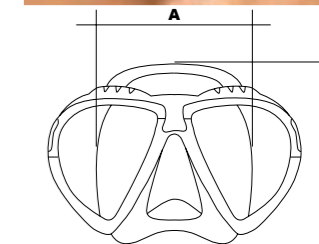

PRODUCT DIMENSION CHART (SKIRT SIZE)

A WIDTH (mm)	B HEIGHT (mm)	A WIDTH (in)	B HEIGHT (in)
112	111	4 13/16	4 6/16

CRESSI'S SIZE CHART IS TO BE USED AS A REFERENCE ONLY



PACKAGING

- U.S. PAT 6272693 B1
- INCLINED LENSES
- MICROMETRIC ADJUSTABLE BUCKLE
- 100% HIGH QUALITY SILICONE SKIRT
- TEMPERED GLASS



LINCE



TECHNICAL FEATURES

- Raked lenses provide excellent field-of-view
- Extremely low internal volume on par with the best free diving masks
- Silicone skirt shaped to provide a wide sealing surface for a leak-free fit
- Micrometric adjustable buckles allow precise headband adjustments
- Inverted tear-drop lenses improve downward vision for viewing your BC while diving

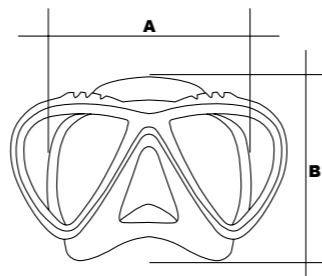

A trimmed down version of the Matrix, the Lince is a perfect fit for many younger divers or those with narrower faces. The extremely low internal volume makes it

comfortable to wear and effortless to clear. Divers and snorkelers alike will appreciate the exceptional field of view offered in this ultra compact mask.

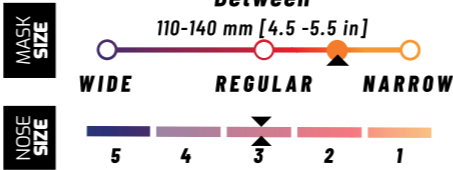

CODE	COLOR	CASE PACK
D5311010	Clear/Yellow	6
D5311020	Clear/Blue	6
D5311030	Clear/Lilac	6
D5311040	Clear/Pink	6
D5311063	Clear/Aquamarine	6
D5312050	Black/Black	6

SPARE PARTS

CODE	PRODUCT
DZ215003	SILICONE STRAP - CLEAR for ITALIAN SCUBA MASK
DZ215004	SILICONE STRAP - BLACK for ITALIAN SCUBA MASK
DZ210018	BUCKLES - BLACK for MATRIX/LINCE/PENTA
DZ215009	STRAP LOOP SMALL for PRO DIVE MASKS - CLEAR (PAIR)
DZ215011	STRAP LOOP SMALL for PRO DIVE MASKS - BLACK (PAIR)

CRESSI PATENTED TECHNOLOGIES

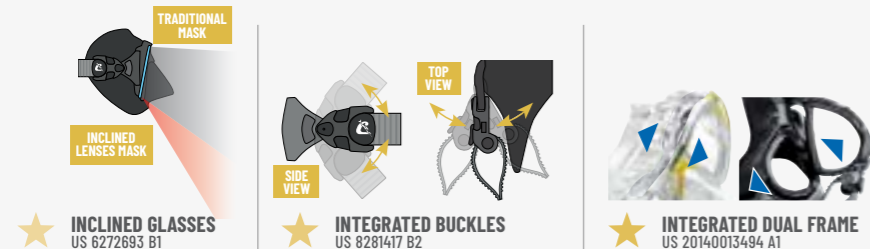

CRESSI'S SIZE CHART IS TO BE USED AS A REFERENCE ONLY
++MEASURE EAR TO EAR WITH A RULER



BIG EYES



TECHNICAL FEATURES

- Raked lenses provide excellent field-of-view
- Inverted tear-drop lenses improve downward visibility for managing BC-mounted gear
- Low internal volume allows for effortless clearing
- High-grade silicone skirt provides a leak-free seal
- Micrometrically adjusting buckles BC while diving

OPTICAL LENSES

Possibility of mounting optical lenses CORRECTION -1.0 > -6.00

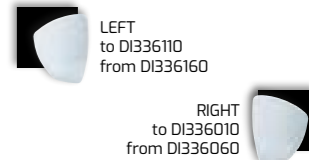

OPTICAL LENSES INSTALLATION \$ 5.00

NOT SYMMETRICAL LENSES

The lenses are positive for correcting negative dioptres (myopia)

COMPLETE INFORMATION OPTICAL LENSES

Please refer to page 172 chart

The mask that began a revolution remains one of the most duplicated designs today. Its inverted tear-drop lens shape and raked lenses provide 30% greater field of view

than typical twin-lens masks. The high-grade silicone skirt's unique shape positions the lenses comfortably close to the eyes and provides an excellent seal.



CODE	COLOR	CASE PACK
D5261010	Clear/Yellow	6
D5261020	Clear/Blue	6
D5261060	Clear/Clear	6
D5261062	Clear/Cobalt	6
D5262020	Black/Blue	6
D5262050	Black/Black	6

SPARE PARTS

CODE	PRODUCT
DZ215005	SILICONE STRAP - CLEAR for BIG EYES/FOCUS
DZ215006	SILICONE STRAP - BLACK for BIG EYES/FOCUS
DZ215007	STRAP LOOP LARGE for FOCUS/BIG EYES - CLEAR (PAIR)
DZ215013	STRAP LOOP LARGE for FOCUS/BIG EYES - BLACK (PAIR)

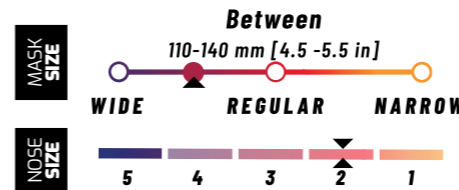
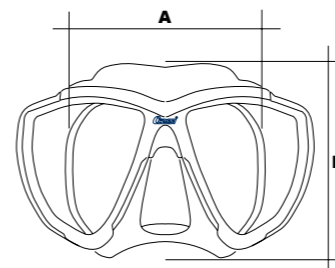

PRODUCT DIMENSION CHART (SKIRT SIZE)			
A WIDTH (mm)	B HEIGHT (mm)	A WIDTH (in)	B HEIGHT (in)
128	108	5 1/16	4 4/16

CRESSI'S SIZE CHART IS TO BE USED AS A REFERENCE ONLY



- EASY ADJUSTABLE BUCKLE
- TEMPERED GLASS
- 100% HIGH QUALITY SILICONE SKIRT

FOCUS



TECHNICAL FEATURES

- Low internal volume allows for effortless clearing
- Lightweight, compact and rugged
- Ideal for travel or as a backup mask
- High-grade silicone skirt provides a leak-free seal
- Fixed quick-adjusting buckles



HD MIRRORED LENSES INCREASE THE VISION'S CLEARNESS BY 15%

OPTICAL LENSES

Possibility of mounting optical lenses CORRECTION -1.0 > -6.00

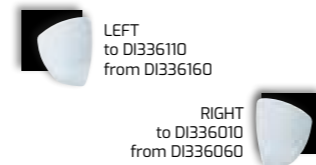

OPTICAL LENSES INSTALLATION \$ 5.00

SYMMETRICAL LENSES

The lenses are positive for correcting negative dioptres (myopia)

COMPLETE INFORMATION

OPTICAL LENSES Please refer to page 172 chart

CODE	PRODUCT
D1240010	Optical Lens -1.0
D1240015	Optical Lens -1.5
D1240020	Optical Lens -2.0
D1240025	Optical Lens -2.5
D1240030	Optical Lens -3.0
D1240035	Optical Lens -3.5
D1240040	Optical Lens -4.0
D1240045	Optical Lens -4.5
D1240050	Optical Lens -5.0
D1240055	Optical Lens -5.5
D1240060	Optical Lens -6.0
D1240065	Optical Lens -6.5
D1240070	Optical Lens -7.0
D1240075	Optical Lens -7.5
D1240080	Optical Lens -8.0

The ultimate in versatility, this classic mask offers the best fit and performance for the greatest variety of facial shapes.

Its low-volume, twin-lens design gives divers

and snorkelers a proven combination of size, fit and durability. Lightweight and easy-to-clear it has swiveling, quick-adjust buckles and accepts corrective lenses. It is also an excellent value.

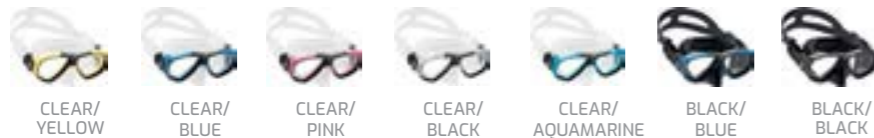

CODE	COLOR	CASE PACK
DS241010	Clear/Yellow	6
DS241020	Clear/Blue	6
DS241040	Clear/Pink	6
DS241060	Clear/Black	6
DS241063	Clear/Aquamarine	6
DS242020	Black/Blue	6
DS242050	Black/Black	6

SPARE PARTS

CODE	PRODUCT
DZ215005	SILICONE STRAP - CLEAR for BIG EYES/FOCUS
DZ215006	SILICONE STRAP - BLACK for BIG EYES/FOCUS
DZ215007	STRAP LOOP LARGE for FOCUS/BIG EYES - CLEAR (PAIR)
DZ215013	STRAP LOOP LARGE for FOCUS/BIG EYES - BLACK (PAIR)

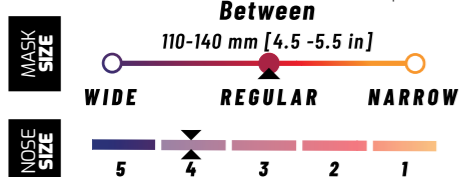
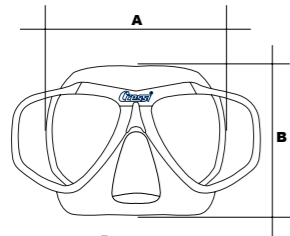

PRODUCT DIMENSION CHART (SKIRT SIZE)			
A WIDTH (mm)	B HEIGHT (mm)	A WIDTH (in)	B HEIGHT (in)
122	105	4 13/16	4 8/16

CRESSI'S SIZE CHART IS TO BE USED AS A REFERENCE ONLY



PACIFICO

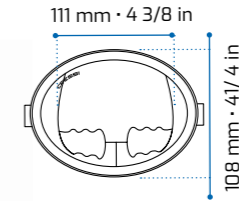

RUBBER MASK

TECHNICAL FEATURES

- Single-lens in a classic retro oval shape
- Scratch-resistant tempered glass for clarity and safety
- Rubber skirt and strap for great seal and comfort
- Easily adjustable buckles

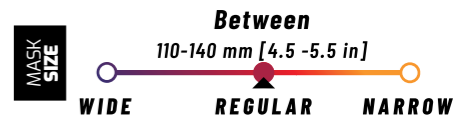

PRODUCT DIMENSION CHART (SKIRT SIZE)

A WIDTH (mm)	B HEIGHT (mm)	A WIDTH (in)	B HEIGHT (in)
120	110	4 12/16	4 15/16

CRESSI'S SIZE CHART IS TO BE USED AS A REFERENCE ONLY

CODE	CASE PACK
ZDN320050	10

TROPICAL

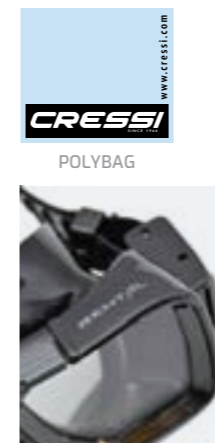
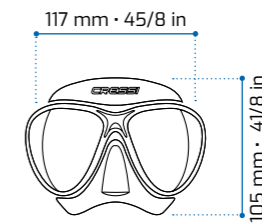

CODE	COLOR	CASE PACK
US401001	Black/Black	10
US401002	Clear/Blue	10
US401003	Black/Black	10

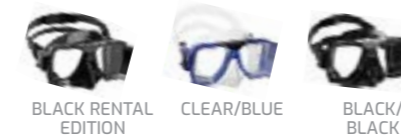

PRODUCT DIMENSION CHART (SKIRT SIZE)

A WIDTH (mm)	B HEIGHT (mm)	A WIDTH (in)	B HEIGHT (in)
116	105	4 9/16	4 2/16

CRESSI'S SIZE CHART IS TO BE USED AS A REFERENCE ONLY

- REDUCED SKIRT
- EASY COMPENSATION
- EXCELLENT VISIBILITY
- ADJUSTING BUCKLE
- 100% HIGH QUALITY SILICONE SKIRT

MINIMA 2022 VINTAGE

THE LOWEST VOLUME ON THE MARKET



TECHNICAL FEATURES

- Materials:** liquid silicone, hi-tech polymers
- Strap buckles:** instant adjustment
- Internal very low volume
- Dimensions of frame:** 168 x 45 mm
- Weight:** 118 g

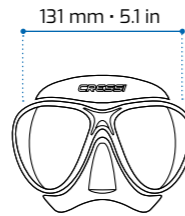

This mask was designed specifically for deep sea diving, with innovative features that place it at the top of its category. The special reduced skirt, complete with a small seal ring, sticks like a suction cup to the face, leaving minimum air space inside the mask, making compensation extremely easy, taking very little air from the lungs.

The lens-eye distance is the absolute smallest on the market and guarantees, even with small diameter lenses, excellent visibility in all directions.

The two optic glass lenses are thicker than the standard to allow a special safety mould.

The strap comes with instantly adjusting buckles for an easy and precise fit.



CODE	CASE PACK
DS292050	6

CODE	PRODUCT
DZ210019	SILICONE STRAP - BLACK for MINIMA

CRESSI PATENTED TECHNOLOGIES

★ **INCLINED GLASSES**
US 6272693 B1

★ **INTEGRATED BUCKLES**
US 8281417 B2

★ **INTEGRATED DUAL FRAME**
US 20140013494 A1



PACKAGING

MASK / SIZE CHART

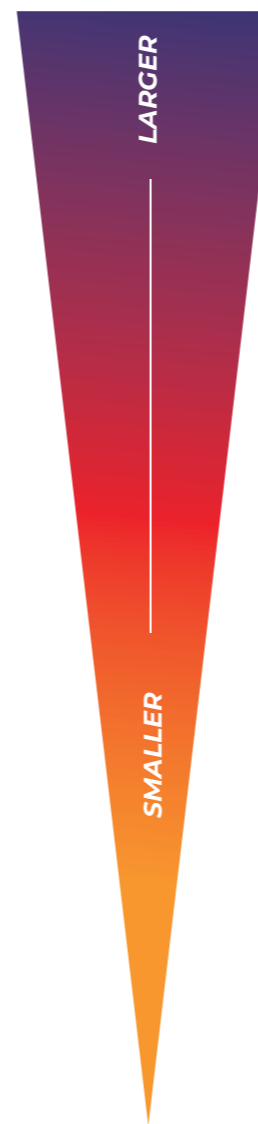

MASK	SKIRT (OUTER)				SIZING GUIDE	GENDER
	WIDTH (MM)	HEIGHT (MM)	WIDTH (IN)	HEIGHT (IN)		
LIBERTY	125	135	4 15 / 16	5 15 / 16	WIDE / REGULAR	ADULT
A1	130	118	5 2 / 16	4 10 / 16	WIDE / REGULAR	ADULT
PANO 3	126	110	4 15 / 16	4 8 / 16	WIDE / REGULAR	ADULT
LIBERTY QUATTRO	125	115	4 15 / 16	4 8 / 16	WIDE / REGULAR	ADULT
LIBERTY TRISIDE	125	110	4 15 / 16	4 5 / 16	WIDE / REGULAR	ADULT
F-DUAL	130	104	5 2 / 16	4 2 / 16	WIDE / REGULAR	ADULT
ONDA	125	103	4 15 / 16	4 1 / 16	WIDE / REGULAR	ADULT
SIRENA	120	114	4 12 / 16	4 8 / 16	WIDE / REGULAR	ADULT
ESTRELLA	125	106	4 15 / 16	4 3 / 16	WIDE / REGULAR	ADULT
BIG EYES EVO	124	110	4 14 / 16	4 5 / 16	REGULAR	ADULT
Z1	122	101	4 13 / 16	4	WIDE / REGULAR	ADULT
ZS1	119	96	4 11 / 16	3 12 / 16	REGULAR	ADULT
LIBERTY DUO	125	108	4 15 / 16	4 4 / 16	WIDE / REGULAR	ADULT
BIG EYES	128	108	5 1 / 16	4 4 / 16	WIDE / REGULAR	ADULT
IKARUS	120	110	4 12 / 16	4 5 / 16	REGULAR	ADULT
MATRIX	122	111	4 13 / 16	4 6 / 16	REGULAR	ADULT
PENTA +	128	112	5 1 / 16	4 7 / 16	REGULAR	ADULT
TROPICAL	116	105	4 9 / 16	4 2 / 16	REGULAR	ADULT
F1	125	110	4 15 / 16	4 5 / 16	REGULAR	ADULT
FOCUS	122	115	4 13 / 16	4 8 / 16	REGULAR	ADULT
MAREA	120	106	4 12 / 16	4 3 / 16	REGULAR	ADULT
PERLA	122	105	4 13 / 16	4 2 / 16	REGULAR	ADULT
PACIFICO	128	140	5	4 6 / 16	REGULAR	ADULT
AIR	115	110	4 8 / 16	4 5 / 16	REGULAR	ADULT
ZEUS	116	108	4 9 / 16	4 4 / 16	REGULAR	ADULT
SF1	129	107	5 1 / 16	4 3 / 16	REGULAR	ADULT
EYES EVO	114	106	4 8 / 16	4 3 / 16	REGULAR	ADULT
METIS	120	105	4 12 / 16	4 2 / 16	REGULAR	ADULT
LINCE	115	118	4 8 / 16	4 10 / 16	REGULAR / NARROW	ADULT
F1 SMALL	117	102	4 10 / 16	4	REGULAR / NARROW	ADULT
CALIBRO	112	103	4 7 / 16	4 1 / 16	REGULAR / NARROW	ADULT
CALIBRO+	112	103	4 7 / 16	4 1 / 16	REGULAR / NARROW	ADULT
NANO	118	104	4 10 / 16	4 2 / 16	REGULAR / NARROW	ADULT
PEGASO	113	113	4 7 / 16	4 7 / 16		KIDS
ESTRELLA JR	112	106	4 7 / 16	4 3 / 16		KIDS
ONDINA	112	100	4 7 / 16	3 15 / 16		KIDS
PERLA JR	111	99	4 6 / 16	3 14 / 16		KIDS
MAREA JR	111	99	4 6 / 16	3 14 / 16		KIDS
MOON	127	73	5	2 14 / 16		KIDS
PIUMETTA	100	100	3 15 / 16	3 15 / 16		KIDS



MASK STRAP LOOP
LARGE CLEAR (PAIR)



CODE
DZ215007

MASK STRAP LOOP
LARGE BLACK (PAIR)



CODE
DZ215013

MASK STRAP LOOP
SMALL CLEAR (PAIR)



CODE
DZ215009

MASK STRAP LOOP
SMALL BLACK (PAIR)



CODE
DZ215011

MASK STRAP
CLEAR - FOCUS / BIG EYES

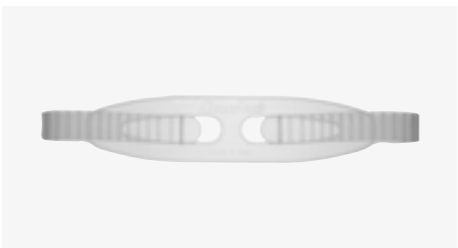

CODE
DZ215005

MASK STRAP
BLACK - FOCUS / BIG EYES / SUPEROCCHIO / PINOCCHIO



CODE
DZ215006

PROFESSIONAL STRAP
CLEAR



CODE
DZ215003

PROFESSIONAL STRAP
BLACK



CODE
DZ215004

STRAP CRYSTAL MASK
SILVER



CODE
DZ215002

TW MASK STRAP

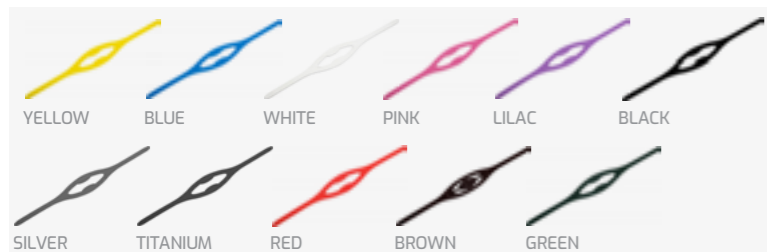

CODE	COLOR
DZ222000	Clear
DZ222010	Yellow
DZ222020	Blue
DZ222030	White
DZ222040	Pink
DZ222041	Lilac
DZ222050	Black
DZ222051	Silver
DZ222072	Titanium
DZ222080	Red
DZ222088	Brown
DZ222090	Green

MASK STRAP



CODE
DZ210019

BUCKLES

BIG EYES MASK BLACK (PAIR)



CODE
DZ210008

BUCKLES

FOCUS MASK BLACK (PAIR)



CODE
DZ210010

BUCKLES

MATRIX / LINCE / PENTA (PAIR)



CODE
DZ210018

BUCKLES

BIG EYES EVOLUTION / OCCHIO PLUS / EYES EVO (2PCS)



CODE
DZ210021

BUCKLES

ONDA/INA /PERLA/JR/SIRENA/ETTA/PIUMETTA/SL A (2PCS)



CODE
DZ210005

BUCKLES

MAREA/MAREA JR /SKY /SKY JR/OCEAN/SL B (2PCS)



CODE
DZ210020

BUCKLES FOR SUPEROCCHIO



CODE
DZ210004

BUCKLES FOR TW MASK



CODE	COLOR
DZ221000	Black/Clear
DZ221030	White/Clear
DZ221040	Pink/Clear
DZ221050	Black/Black

OPTICAL LENSES

| FOCUS

Please also refer to the Cressi Spare Parts Catalog for further information and Technical Details

» The Optical Lens are sold individually. The Focus lenses can be mounted both for left and right.

CODE	SIZE	STYLE
DI240010	- 1.0 diopter	Focus
DI240015	- 1.5 diopter	Focus
DI240020	- 2.0 diopter	Focus
DI240025	- 2.5 diopter	Focus
DI240030	- 3.0 diopter	Focus
DI240035	- 3.5 diopter	Focus
DI240040	- 4.0 diopter	Focus
DI240045	- 4.5 diopter	Focus
DI240050	- 5.0 diopter	Focus
DI240055	- 5.5 diopter	Focus
DI240060	- 6.0 diopter	Focus
DI240065	- 6.5 diopter	Focus
DI240070	- 7.0 diopter	Focus
DI240075	- 7.5 diopter	Focus
DI240080	- 8.0 diopter	Focus

OPTICAL LENSES

| BIG EYES EVOLUTION | BIG EYES

Please also refer to the Cressi Spare Parts Catalog for further information and Technical Details

CODE	SIZE	STYLE
DI336010	Right -1.0	Big Eyes Evo
DI336015	Right -1.5	Big Eyes Evo
DI336020	Right -2.0	Big Eyes Evo
DI336025	Right -2.5	Big Eyes Evo
DI336030	Right -3.0	Big Eyes Evo
DI336035	Right -3.5	Big Eyes Evo
DI336040	Right -4.0	Big Eyes Evo
DI336045	Right -4.5	Big Eyes Evo
DI336050	Right -5.0	Big Eyes Evo
DI336055	Right -5.5	Big Eyes Evo
DI336060	Right -6.0	Big Eyes Evo
DI336110	Left -1.0	Big Eyes Evo
DI336115	Left -1.5	Big Eyes Evo
DI336120	Left -2.0	Big Eyes Evo
DI336125	Left -2.5	Big Eyes Evo
DI336130	Left -3.0	Big Eyes Evo
DI336135	Left -3.5	Big Eyes Evo
DI336140	Left -4.0	Big Eyes Evo
DI336145	Left -4.5	Big Eyes Evo
DI336150	Left -5.0	Big Eyes Evo
DI336155	Left -5.5	Big Eyes Evo
DI336160	Left -6.0	Big Eyes Evo
DI260010	Right -1.0	Big Eyes
DI260015	Right -1.5	Big Eyes
DI260020	Right -2.0	Big Eyes
DI260025	Right -2.5	Big Eyes
DI260030	Right -3.0	Big Eyes
DI260035	Right -3.5	Big Eyes
DI260040	Right -4.0	Big Eyes
DI260045	Right -4.5	Big Eyes
DI260050	Right -5.0	Big Eyes
DI260055	Right -5.5	Big Eyes
DI260060	Right -6.0	Big Eyes
DI260110	Left -1.0	Big Eyes
DI260115	Left -1.5	Big Eyes
DI260120	Left -2.0	Big Eyes
DI260125	Left -2.5	Big Eyes
DI260130	Left -3.0	Big Eyes
DI260135	Left -3.5	Big Eyes
DI260140	Left -4.0	Big Eyes
DI260145	Left -4.5	Big Eyes
DI260150	Left -5.0	Big Eyes
DI260155	Left -5.5	Big Eyes
DI260160	Left -6.0	Big Eyes



ANTI-FOG SPRAY

160 ML



Effective anti-fog for masks and goggles.
Spread on the inside of the lenses, before wetting them.

CODE
DF200050

ANTIFOG GEL

130 ML



Effective anti-fog for masks and goggles.
Spread on the inside of the lenses, before wetting them.

CODE
DF200052

MINIFOG SPONGE

115 ML



It incorporates a sponge that allows a very precise dosage and, therefore, a great saving of product. The sponge contributes to the elimination of the grease film of the glass produced by the vapors of the silicone after its vulcanization.

CODE
DF200053

MASK STRAP COVER

1 SOFT NEOPRENE



CODE	COLOR
DS339992	Blue
DS339994	Pink
DS339995	Black
DS339996	Yellow
DS339997	Red

SIMPLY MASK STRAP COVER NEW 2022

1 SOFT NEOPRENE



CODE	COLOR
DQ011050	Yellow/Black
DQ012030	Blue/White
DQ015010	Black/Yellow

PONY TAIL MASK STRAP COVER NEW 2022

1 SOFT NEOPRENE



CODE	COLOR
DQ021050	Yellow/Black
DQ022030	Blue/White
DQ024030	Pink/White
DQ025010	Black/Yellow

SPLASH GUARD | PURGE VALVE | 100% HIGH QUALITY SILICONE MOUTHPIECE

CORFÚ

| SPLASH GUARD | PURGE VALVE



SILVER/BLUE



WHITE/LILAC



SILVER/YELLOW



SILVER/PINK



SILVER/BLACK



BLACK/BLACK

TECHNICAL FEATURES

- **Profiled splash guard:** significantly reduces water entry
- **Mouthpiece:** drops away when not in use - great for scuba divers
- **High-quality silicone mouthpiece:** is comfortable and durable
- **Angled anatomical mouthpiece:** reduces jaw fatigue
- **Lower purge valve:** allows water to be quickly expelled
- **Streamlined design:** reduces drag while swimming
- Adjustable clip for securing to any mask

- » Profiled splash guard
- » Purge valve
- » Quick release snorkel keeper
- » 100% high-quality soft silicone

PROFILED
SPLASH GUARD



QUICK RELEASE
SNORKEL HOLDER



PURGE VALVE



Snorkel designed mainly for snorkeling, apnea and diving. The tube (curved shape and soft material) has a variable section and in the upper part ends with an innovative splash guard, which drastically reduces water entry from waves, without interfering with breathing.

The mouthpiece, made of soft silicone, has an angle studied in a particularly ergonomic way, with a reduced bite size for prolonged use without gum fatigue. The mouthpiece body consists of two pieces, with an inclination that ensures better and faster water drainage. A lower purge valve enables instant clearing when needed.

CODE	COLOR	CASE PACK
E5300020	Silver/Blue	6
E5300041	White/Lilac	6
E5300051	Silver/Yellow	6
E5300054	Silver/Pink	6
E5300055	Silver/Black	6
E5300150	Black/Black	6

SPARE PARTS

CODE	PRODUCT
E2267015	SNORKEL KEEPER for ALPHA ULTRA DRY/BETA - GREY
E2270017	MOUTHPIECE for ALPHA/BETA/CORFU/ITACA - BLACK
E2270019	MOUTHPIECE for ALPHA/BETA/CORFU/ITACA - CLEAR



SNORKELS

SCUBA



70 YEARS
MANUFACTURE
QUALITY SINCE
1946

DRY GUARD | PURGE VALVE | 100% HIGH QUALITY SILICONE MOUTHPIECE

ITACA ULTRA DRY

| DRY TOP | PURGE VALVE

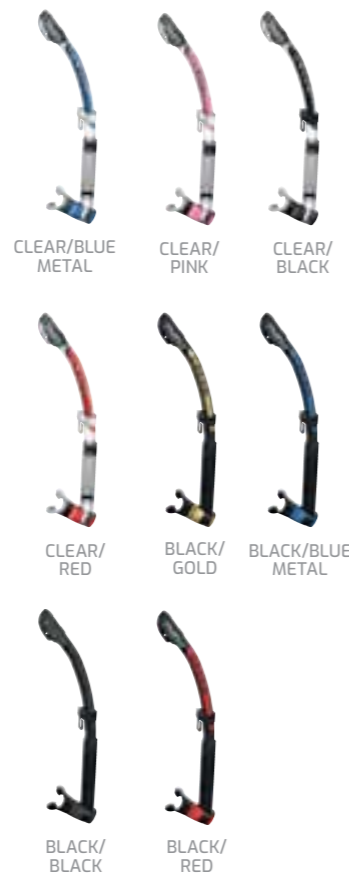

TECHNICAL FEATURES

- **Special patented new Aquastop valve:** very efficient on up / down positions
- **Dry guard:** seals breathing tube when submerged
- **Mouthpiece:** drops away when not in use - great for scuba divers
- **High-quality silicone mouthpiece:** is comfortable and durable
- **Angled anatomical mouthpiece:** reduces jaw fatigue
- **Lower purge valve:** allows water to be quickly expelled
- Streamlined design reduces drag while swimming
- Adjustable clip for securing to any mask

- » Dry top valve
- » Purge valve
- » 100% high quality soft silicone
- » Quick release snorkel keeper

PATENTED AQUASTOP DRY GUARD 360° DRY PROTECTION TECHNOLOGY

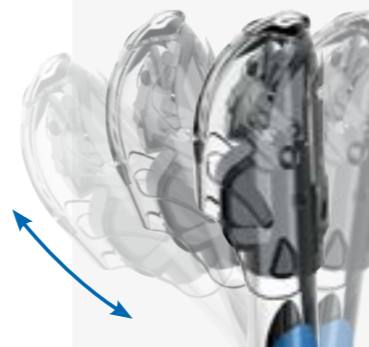

It features at the top end an International patented dry guard, which prevents water entry while using it on the surface in any position. The new mechanical device has three movement joints, whose counterweight ensures immediate opening of the upper valve, whether you dive or emerge from the water. The lower part is equipped on the inner side with a smooth flexible corrugated section, which keeps the aerator away from the mouth while using any breathing apparatus.

The mouthpiece, made of soft silicone, has an angle studied in a particularly ergonomic way, with a reduced bite size for prolonged use without gum fatigue. The mouthpiece body consists of two pieces, with an inclination that ensures better and faster water drainage. A lower purge valve enables instant clearing when needed. The transparent tube has a side reinforcement in colored rubber.

CODE	COLOR	CASE PACK
ES290020	Clear/Blue	6
ES290040	Clear/Pink	6
ES290050	Clear/Black	6
ES290058	Clear/Red	6
ES290109	Black/Gold	6
ES290120	Black/Blue	6
ES290150	Black/Black	6
ES290158	Black/Red	6



Photo by - Chris - Miskovitch

SPARE PARTS

CODE	PRODUCT
EZ267015	SNORKEL KEEPER for ALPHA ULTRA DRY/BETA - GREY
EZ270017	MOUTHPIECE for ALPHA/BETA/CORFU/ITACA - BLACK
EZ270019	MOUTHPIECE for ALPHA/BETA/CORFU/ITACA - CLEAR



PATENTED AQUASTOP DRY GUARD WITH 360° DRY PROTECTION TECHNOLOGY



PURGE VALVE

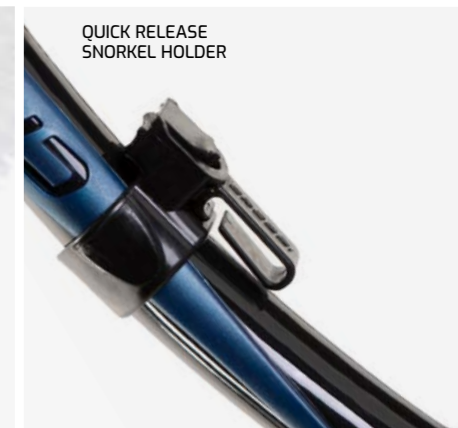

QUICK RELEASE SNORKEL HOLDER

DRY GUARD | PURGE VALVE | 100% HIGH QUALITY SILICONE MOUTHPIECE

ALPHA ULTRA DRY

| DRY TOP | PURGE VALVE



TECHNICAL FEATURES

- Dry Valve Technology seals breathing tube when submerged at any angle
- Flexible tube allows folding for storage
- **Mouthpiece drops away when not in use:** great for scuba divers
- Angled mouthpiece reduces jaw fatigue
- Lower purge valve allows any water to be quickly expelled
- Streamlined design reduces drag while swimming
- Adjustable snorkel keeper for securing to any mask

- » Dry top valve
- » 100% high-quality silicone
- » Bottom purge valve

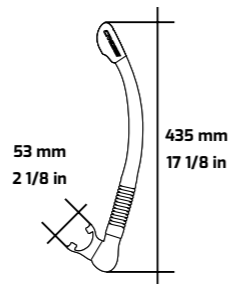

ULTRA FLEXIBLE TUBE



ANGLE DRY PROTECTION TECHNOLOGY



QUICK RELEASE SNORKEL KEEPER



The Alpha Ultra Dry uses the latest dry-top snorkel technology with a compact valve that automatically closes to keep water out regardless of the angle of the snorkel. The Alpha also has a new, highly flexible tube

that reduces jaw fatigue and folds compactly for storing in a BC pocket or travel pack. A new, wider elliptical shape increases air flow capacity for more comfortable breathing, while the purge valve enables instant clearing.

CODE	COLOR	CASE PACK
ES258020	Blue/Azure/Clear	6
ES258041	White/Lilac/Clear	6
ES258051	Black/Yellow/Clear	6
ES258054	Black/Pink/Clear	6
ES258055	Black/Silver/Clear	6
ES258130	Black/White/Black	6
ES258150	Black/Black/Black	6

SPARE PARTS

CODE	PRODUCT
EZ267015	SNORKEL KEEPER for ALPHA ULTRA DRY/BETA - GREY
EZ270017	MOUTHPIECE for ALPHA/BETA/CORFU/ITACA - BLACK
EZ270019	MOUTHPIECE for ALPHA/BETA/CORFU/ITACA - CLEAR

DRY GUARD | PURGE VALVE | 100% HIGH QUALITY SILICONE MOUTHPIECE

SUPERNOVA DRY

| DRY TOP | PURGE VALVE

TECHNICAL FEATURES

- Dry-top valve seals breathing tube when submerged
- Flexible lower bore reduces jaw fatigue
- Mouthpiece drops away when not in use great for scuba divers
- High-quality silicone mouthpiece is comfortable and durable
- Angled mouthpiece reduces jaw fatigue
- Lower purge valve allows water to be quickly expelled
- Streamlined design reduces drag while swimming
- Adjustable snorkel keeper for securing to any mask

- » Dry top valve
- » Quick release snorkel keeper
- » Bottom purge valve
- » Hypoallergenic soft silicone mouthpiece
- » Flexible corrugated silicone tube

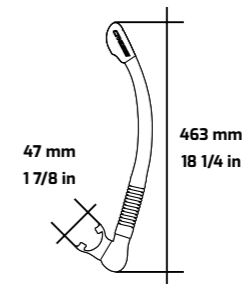

DRY GUARD



QUICK RELEASE SNORKEL KEEPER



PURGE VALVE



CODE	COLOR	CASE PACK
ES259010	Clear/Yellow	50
ES259020	Clear/Cobalt	50
ES259030	Clear/White	50
ES259040	Clear/Pink	50
ES259050	Clear/Black	50
ES259062	Clear/Blue	50
ES259080	Clear/Lilac	50
ES259510	Black/Yellow	50
ES259520	Black/Blue	50
ES259550	Black/Black	50
ES259558	Black/Red	50

SPARE PARTS

CODE	PRODUCT
EZ267018	SNORKEL KEEPER for SUPERNOVA DRY/TAO/TAO DRY - BLACK
EZ267018W	SNORKEL KEEPER for SUPERNOVA DRY/TAO/TAO DRY - WHITE
EZ270022	MOUTHPIECE for SUPERNOVA DRY/TAO/TAO DRY - BLACK
EZ270024	MOUTHPIECE for SUPERNOVA DRY/TAO/TAO DRY - CLEAR

TAO DRY

| DRY TOP | PURGE VALVE



COLORAMA EDITION



TECHNICAL FEATURES

- Dry-top valve seals breathing tube when submerged
- Flexible lower bore reduces jaw fatigue
- High-quality silicone mouthpiece is comfortable and durable
- Angled mouthpiece reduces jaw fatigue
- Lower purge valve allows water to be quickly expelled
- Removable adjustable snorkel keeper for securing to any mask

- » Dry top valve
- » Bottom purge valve
- » Quick release snorkel keeper
- » Hypoallergenic soft silicone mouthpiece
- » Flexible corrugated silicone tube



The Tao Dry is a dry snorkel that allows divers to take every breath with confidence and focus on the reef below, not worrying about water in your air way. The top has a

Splash Guard and a floating mechanism that prevents entry of water when submerged. The contoured tube provides ample airflow and a lower purge valve enables instant clearing.

CODE	COLOR	CASE PACK
ES261001	Clear/Yellow	10
ES261002	Clear/Blue	10
ES261010	Yellow/Yellow	10
ES261020	Blue/Blue	10
ES261040	Pink/Pink	10
ES261041	Lilac/Lilac	10
ES261050	Black/Clear	10
ES261550	Black/Black	10

SPARE PARTS

CODE	PRODUCT
EZ267018	SNORKEL KEEPER for SUPERNOVA DRY/TAO/TAO DRY - BLACK
EZ267018W	SNORKEL KEEPER for SUPERNOVA DRY/TAO/TAO DRY - WHITE
EZ270022	MOUTHPIECE for SUPERNOVA DRY/TAO/TAO DRY - BLACK
EZ270024	MOUTHPIECE for SUPERNOVA DRY/TAO/TAO DRY - CLEAR



TAO

| SEMI-DRY TOP | PURGE VALVE



TECHNICAL FEATURES

- Profiled splash guard significantly reduces water entry
- Flexible lower bore reduces jaw fatigue
- High-quality silicone mouthpiece is comfortable and durable
- Angled mouthpiece reduces jaw fatigue
- Lower purge valve allows water to be quickly expelled
- Removable adjustable snorkel keeper for securing to any mask

- » Top splash guard
- » Quick release snorkel keeper
- » Hypoallergenic soft silicone mouthpiece
- » Flexible corrugated silicone tube
- » Bottom purge valve

The Tao is a semi-dry snorkel that allows divers to take every breath with confidence and focus on the reef below not on worrying about water in your air way. The top Splash

Guard is designed to reduce water intake. A generous bore contoured tube provides ample airflow and a lower purge valve enables instant clearing when needed.

CODE	COLOR	CASE PACK
ES260050	Clear/Black	10
ES260550	Black/Black	10

SPARE PARTS

CODE	PRODUCT
EZ267018	SNORKEL KEEPER for SUPERNOVA DRY/TAO/TAO DRY - BLACK
EZ267018W	SNORKEL KEEPER for SUPERNOVA DRY/TAO/TAO DRY - WHITE
EZ270022	MOUTHPIECE for SUPERNOVA DRY/TAO/TAO DRY - BLACK
EZ270024	MOUTHPIECE for SUPERNOVA DRY/TAO/TAO DRY - CLEAR



F-DUAL & SUPERNOVA DRY

COMBOS



TECHNICAL FEATURES

- MASK**
- Frameless technology for maximum comfort
 - Single tempered glass lens
 - Wide field of view
 - High-grade soft silicone
 - Double feathered edge skirt
 - Quick-adjustable strap buckles
 - Easy-access nose pocket for 1-handed ear equalization
- SNORKEL**
- Dry-top valve seals breathing tube when submerged
 - Flexible lower bore reduces jaw fatigue
 - Mouthpiece drops away when not in use great for scuba divers
 - High-quality silicone mouthpiece is comfortable and durable
 - Angled mouthpiece reduces jaw fatigue
 - Lower purge valve allows water to be quickly expelled
 - Streamlined design reduces drag while swimming
 - Adjustable snorkel keeper for securing to any mask



CLEAR/BLUE WHITE/PINK BLACK/BLUE BLACK/WHITE BLACK/RED

CODE	COLOR	CASE PACK
DM330020	Clear/Blue	20
DM333430	White/Pink	20
DM335020	Black/Blue	20
DM335030	Black/White	20
DM335080	Black/Red	20





BIG EYES EVO + ALPHA ULTRA DRY

BIG EYES & SUPERNOVA DRY



CODE	COLOR	CASE PACK
DS337010	Clear/Yellow	6
DS337050	Clear/Black	6

CODE	COLOR	CASE PACK
ZDS260020	Blue	5
ZDS260060	Clear	5
ZDS260062	Cobalt	5
ZDS260500	Black	5

SNORKEL KEEPER

ALPHA ULTRA DRY • ITACA ULTRA DRY • BETA • CORFU



CODE	COLOR
EZ267015	Black

SNORKEL KEEPER

SUPERNOVA DRY • TAO DRY • TAO



CODE	COLOR
EZ267018	Black
EZ267018W	White

SNORKEL KEEPER

CORSICA • MEXICO • GAMMA



CODE	COLOR
EZ267005	Black
EZ267009	Clear

SNORKEL KEEPER

GRINGO



CODE	COLOR
EZ260003	Black
EZ265003	Clear

SNORKEL KEEPER

AMERICA • TOP



CODE	COLOR
EZ267004	Black
EZ267011	Clear

SNORKEL KEEPER

MINI DRY



CODE	COLOR
EZ267019B	Black
EZ267019	White

SNORKEL KEEPER

KAPPA • SIGMA



CODE	COLOR
EZ267013	Grey

BARBEL SNORKEL KEEPER

UNIVERSAL



CODE	COLOR
EZ267013B	Black

SNORKEL MOUTHPIECE

ALPHA ULTRA DRY • ITACA ULTRA DRY • BETA • CORFU



CODE COLOR

EZ270017 Black

EZ270019 Clear

SNORKEL MOUTHPIECE

SUPERNOVA DRY • TAO DRY • TAO



CODE COLOR

EZ270022 Black

EZ270024 Clear

SNORKEL MOUTHPIECE

CORSICA • MEXICO



CODE COLOR

EZ270029 Black

EZ270031 Clear

EZ270120 Blue Metal

EZ270130 White

SNORKEL MOUTHPIECE

GAMMA • KAPPA • SIGMA



CODE COLOR

EZ270001 Clear

EZ270002 Black

SNORKEL MOUTHPIECE

GRINGO



CODE COLOR

EZ270007 Black

EZ270008 Clear

SNORKEL MOUTHPIECE

AMERICA



CODE COLOR

EZ270006 Black

SNORKEL MOUTHPIECE

TOP



CODE COLOR

EZ270036 Clear

SNORKEL MOUTHPIECE

MINI DRY



CODE COLOR

EZ270026 Clear



WHITE COLOR TEMPERATURE | ADJUSTABLE ELASTIC STRAP | EXCELLENT ERGONOMICS | SWITCH WITH 3 POSITIONS | LED LIGHT TECHNOLOGY | PREMIUM MATERIALS | NARROWED LIGHT BEAM

LUMIA+ NEW 2022

I ULTRA LED DIVE LAMP

Torch with a highly asymmetric design boasts excellent ergonomics and a highly tactile perception of its geometric characteristics. Thanks to this particular design, the switch position is immediately found without needing to use your eyesight. The porthole and body are coated with thermoplastic rubber to extend shelf life and reduce noises from impact when used for fishing. These ergonomic features are a big advantage over aluminium torches with a circular section which do not give feedback on the position of the grip and, in some cases, even require the use of two hands

to turn it on. The switch has three positions: Off, On Unstable with Automatic Return, On. The "On Unstable" position is particularly useful in fishing because it allows flashing by one simple press. The strap with slider spring allows adjustment according to the user's needs, but being elastic can be pulled out in case of emergency. Power is supplied by four AA batteries, either alkaline or rechargeable. The electronics ensure a constant level of brightness even when the batteries are rechargeable and/or not fully charged. Batteries included.

TECHNICAL FEATURES

- Luminous Flux: 300 Lumens
- Color Temperature: 6500 K CRI>75
- Burn Time: 3.5 h
- Viewing Angle: 6°
- Illuminance: 30000 Lux
- Impact Resistance: 1.5 m · 5 ft
- Ingress Protection Code: PX-B 75m

NEW WHITE COLOR TEMPERATURE

The LED has a white color temperature similar to sunlight for maximum return of the colors in the underwater environment. The light beam of the LED is narrowed into a spot light beam of about 6° by means of a lens made of ultra-transparent material protected by the polycarbonate optical porthole.

ACTIVE ELECTRONICS

Power is supplied by four AA batteries, either alkaline or rechargeable. The power supply has an electronic management system that eliminates the gap between the different electrical potentials of different types of batteries and ensures an efficiency of 30% higher than the commonly used systems. The active electronics of the flashlight guarantee constant light, even when the battery charge decreases. When the charge drops below the safety threshold value, the lighting level will reduce to warn the user that the batteries are depleted.

Length	168 mm - 6.61 in
Head diameter	47 mm - 1.85 in
Weight	130 g - 4.58 oz (without batteries)

LUMIA + HIGH RANGE COLOR SPECTRUM



STANDARD LIGHT LIMITED RANGE COLOR SPECTRUM

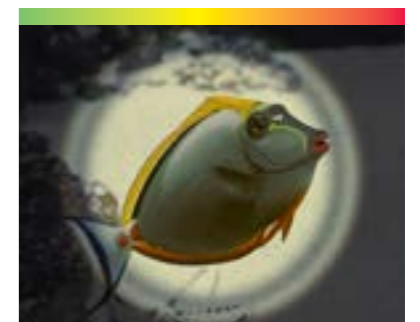

EXCELLENT ERGONOMICS

THANKS TO THERMOPLASTIC RUBBER COATING AND HIGHLY ASYMMETRIC DESIGN

SWITCH WITH 3 POSITIONS

ON | OFF | HOLDING ON WITH AUTOMATIC RETURN

NARROWED LIGHT BEAM

APPROXIMATELY 6° SPOT LIGHT BEAM THANKS TO TIR LENS

ADJUSTABLE ELASTIC STRAP

TO CUSTOMISE THE USE ACCORDING TO YOUR NEEDS

NEUTRAL WHITE COLOR TEMPERATURE

SIMILAR TO SUNLIGHT FOR MAXIMUM RETURN OF THE COLORS



BLACK/BLACK



BLACK/GREY



CODE	COLOR	CASE PACK
SJ550150	Black/Black	10
SJ550170	Black/Grey	10



Photo by Marcello Postanesi

LUMIA

35 WE
MANUFACTURE
QUALITY SINCE
1946



BUYER'S GUIDE
 1946



GRIP

I BLUNT TIP

Grip Blunt Tip Knife is a small-sized knife with a blunt tip and two different types of blades for multi-use. Great for scuba diving, as primary knife or back-up.

TECHNICAL FEATURES

- Kit included
- High quality Japanese stainless steel
- Dagger style blade with pointed tip
- Smooth cutting blade that is lightweight, but strong
- Small, easy release sheath features one-handed operation
- Serrated top blade for easy underwater cutting
- Opening at base of handle for easy lanyard attachment
- Rear plate for bc strap attachment bc hose mounting

- › Rear plate for bc strap attachment
- › Hose attachment included
- › BC mount straps included

TOTAL LENGTH 6.80 IN / 17.50 CM

BLADE LENGTH 2.80 IN / 7.30 CM

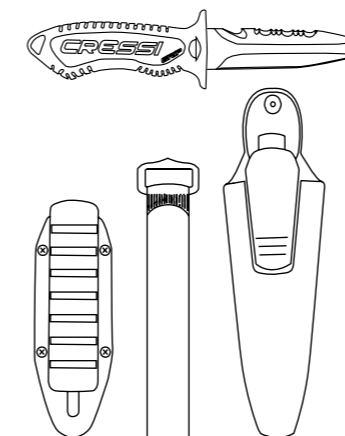

CODE CASE PACK
 RC559410 5



PACKAGING

BORG

I BLUNT TIP

Version of the Borg knife with the chisel tip to allow it to be used as a tool for various operations and avoid accidental damage caused by a sharp tip.

TECHNICAL FEATURES

- One side of the stainless steel blade is straight-edged, the other one is serrated right along the blade; they are both very sharp and effective for line cutting
- It is separated from the blade by a small technopolymer thumb tab
- Sheath with locking mechanism to allow one-hand release The knife is supplied with two leg straps

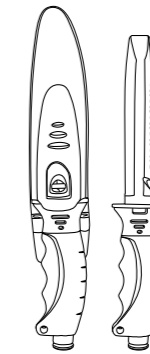

PACKAGING

CODE CASE PACK
 RC559150 10



CLEAN-UP TOOLS

LINE CUTTER

Simple, efficient line cutting tool with safety-blade design. The sheath can be mounted on harness rig or on a B.C.D.



CODE
RC555500

ALLIGATOR

2 IN 1 SCISSOR + KNIFE



CODE
RC559200

SPIDER MESH BAG



DESCRIPTION:

The Spider Mesh Bag is great when you need to carry your wet scuba gear or your snorkeling equipment. Thanks to its net design, it lets the equipment dry fast. The mesh is made of strong polyester fabric, a material that resists weight and dries quickly. It has a high storage capacity, enough for carrying a complete scuba set (BCD, regulator, gauges, octopus) and even mask, fins and snorkel and also wetsuits. It features a drawstring closure with a barrel lock fastener.

DIMENSIONS: 61 x 91 cm | 24 x 36 in.

CODE CASE PACK
UB939000 10

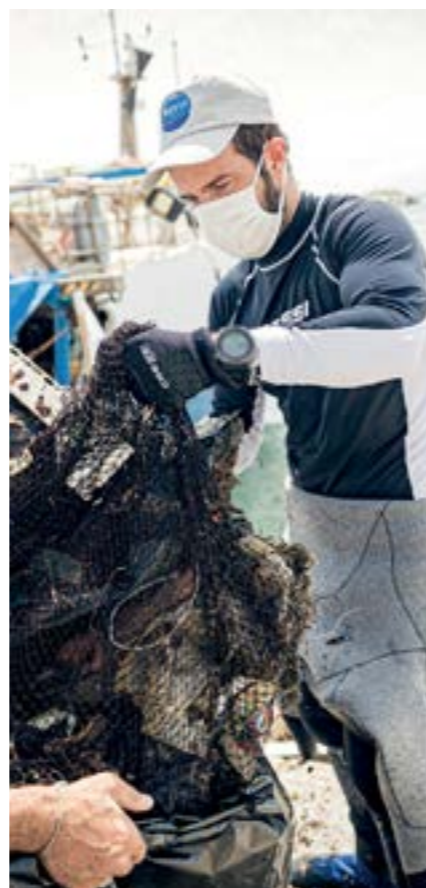

WETSUITS

SCUBA

THICKNESS 4 MM HIGH DENSITY | METALLIC BACK ZIP | HIGH STRETCH SPANFLEX MATERIAL | LIQUID SEAL TECHNOLOGY

DESERT

I DRYsuit WITH LIQUID SEAL TECHNOLOGY



TECHNICAL FEATURES

- High-density 4 mm thick pre-compressed neoprene
- Soft neoprene socks
- Internal suspender system
- Fly with concealed zip
- Zipper made by BDM, a YKK company
- Heavy duty kneepads
- Side action rotating inflation valve
- Adjustable discharge relief valve



LIQUID SEAL TECHNOLOGY

A layer of polymer is spread along the seams to protect and seal them, thereby increasing the resistance to wear, the lifetime of the suit, and its insulating power.

Comfortable and resistant Dry Suit thanks to its 4mm thick High-Density pre-compressed Neoprene and thanks to the Liquid Seal protected stitched joints. The seams and outer neoprene lining are covered with a special layer of elastomer so as to simultaneously create an impermeable obstacle for the water and increased resistance at the joints. On the inside, an additional sealing strip guarantees total waterproof-ability. This double sealing system has been carefully designed to meet the needs of the most discerning and seasoned divers that often require their dry suits to be able to adapt to extreme working or weather conditions. The

special Spanflex material has also been used in the outer part so as to increase elasticity and abrasion resistance. The cuffs are made of smooth 3.5 mm-thick neoprene on the inside in order to improve sealability and from Ultraspan on the outside in order to improve elasticity. The collar is made of the same materials but with 2.5mm-thick neoprene for more comfort and breathability when turned-up. The shoulder neck and knee lines are reinforced with a special anti-abrasion X-Diamond Pad lining. The suit comes with a practical multipurpose pocket placed on the right leg as well as a comfortable hood.

MAN

CODE	SIZE	CASE PACK
LQ401002	S	1
LQ401003	M	1
LQ401004	L	1
LQ401005	XL	1
LQ401006	2XL	1
LQ401007	3XL	1

LADY

CODE	SIZE	CASE PACK
LQ401101	XS	1
LQ401102	S	1
LQ401103	M	1
LQ401104	L	1
LQ401105	XL	1

RECYCLED MATERIALS | BASE LAYER NEW FLEECE FABRIC

DRYSUIT UNDERSUIT

I THERMAL UNDERSUIT



TECHNICAL FEATURES

- Recycled Polyester + Recycled Spandex
- Thumb-hole Design
- 550 G/YD
- Front zipper
- Anatomical cuts

> Base Layer

> New Fleece Fabric



UNISEX

CODE	SIZE	CASE PACK
LW475011	XS	10
LW475012	S	10
LW475013	M	10
LW475014	L	10
LW475015	XL	10
LW475016	2XL	10
LW475017	3XL	10

THICKNESS 7 MM | BACK ZIP | 10-18° C 50-64.4° F CE CERTIFICATION DIVING WETSUIT EN 14225-1:2017: B

PREMIUM ULTRASTRETCH NEOPRENE | SPECIALIZED Retailer Product

FAST

| 7 mm



ULTRASOFT NEOPRENE ON ARMS

ANTI-ABRASION REINFORCEMENT

ULTRASOFT NEOPRENE

ULTRA SOFT NEOPRENE ON CALVS

10° - 18° C 50° - 64° F

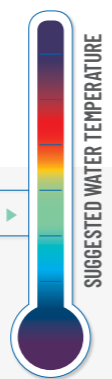

...FLEX Area

Cressi wetsuit designs guarantee complete adherence to the body, just like a second skin. The flex areas facilitate movement, ensuring complete comfort and ease of donning and motion, especially in the arm and ankle areas.

TECHNICAL FEATURES

- One-piece wetsuit in 7 mm double lined neoprene
- Ultraspan neoprene on arms and calves
- Pre-shaped legs
- YKK back zip with under zip lining and water-stop system
- Anti-abrasion reinforcement on the knees
- Wrists and ankles with water-stop system / watertight seals

UNDER ZIP LINING CLOSE



UNDER ZIP LINING OPEN



WATERTIGHT SEALS



NEW DESIGN KNEEPAD



Stylish, warm and versatile, the Fast can be used in the widest range of temperate and cold waters. Durable 7 mm, double-lined

neoprene, stands up well to compression at depth for maximum heat retention. Pre-shaped legs improve flexibility for easier kicking.

MAN

CODE	SIZE	CASE PACK
LR108702	S	5
LR108703	M	5
LR108704	L	5
LR108705	XL	5
LR108706	2XL	5
LR108707	3XL	5

LADY

CODE	SIZE	CASE PACK
LR109701	XS	5
LR109702	S	5
LR109703	M	5
LR109704	L	5
LR109705	XL	5

THICKNESS 5 MM | BACK ZIP | 16-24° C 60.8-75.2° F CE CERTIFICATION DIVING WETSUIT EN 14225-1:2017: B

ULTRASOFT NEOPRENE | SPECIALIZED Retailer Product

OTTERFLEX

| 5 mm



ANTI-ABRASION REINFORCEMENT

...FLEX Area

Cressi wetsuit designs guarantee complete adherence to the body, just like a second skin. The flex areas facilitate movement, ensuring complete comfort and ease of donning and motion, especially in the arm and ankle areas.

TECHNICAL FEATURES

- One-piece wetsuit in 5 mm double lined neoprene
- Ultraspan neoprene on arms and calves
- Pre-shaped legs
- YKK back zip with under zip lining and water-stop system
- Anti-abrasion reinforcement on the knees
- Wrists and ankles with water-stop system / watertight seals

WATERTIGHT SEALS



UNDER ZIP LINING



NEW DESIGN KNEEPAD



Stylish, warm and versatile, the Fast can be used in the widest range of temperate waters. Durable 5 mm, double-lined neoprene, stands

up well to compression at depth for maximum heat retention. Pre-shaped legs improve flexibility for easier kicking.

MAN

CODE	SIZE	CASE PACK
LR131002	S	5
LR131003	M	5
LR131004	L	5
LR131005	XL	5
LR131006	2XL	5
LR131007	3XL	5

LADY

CODE	SIZE	CASE PACK
LR132001	XS	5
LR132002	S	5
LR132003	M	5
LR132004	L	5
LR132005	XL	5



THICKNESS 3 MM | BACK ZIP | 1-22° C >71.6° F | CE CERTIFICATION DIVING WETSUIT EN 14225-1:2017: D

FAST

3 mm

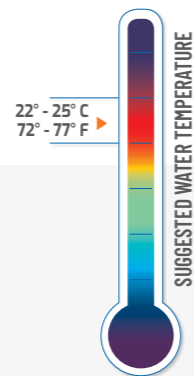

...FLEX Area

Cressi wetsuit designs guarantee complete adherence to the body, just like a second skin. The flex areas facilitate movement, ensuring complete comfort and ease of donning and motion, especially in the arm and ankle areas.

Stylish, warm and versatile, the Fast can be used in the widest range of temperate waters. Durable 3 mm neoprene, pre-shaped legs

improve flexibility for easier kicking and anti-abrasion reinforcement on the knees.

MAN

CODE	SIZE	CASE PACK
LR108302	S	5
LR108303	M	5
LR108304	L	5
LR108305	XL	5
LR108306	2XL	5
LR108307	3XL	5

LADY

CODE	SIZE	CASE PACK
LR109301	XS	5
LR109302	S	5
LR109303	M	5
LR109304	L	5
LR109305	XL	5

ULTRASOFT NEOPRENE | SPECIALIZED Retailer Product

TECHNICAL FEATURES

- One-piece wetsuit in 3 mm double-lined neoprene
- Pre-shaped legs
- YKK back zip with under zip lining
- Anti-abrasion reinforcement on the knees

UNDER ZIP LINING



NEW DESIGN KNEEPAD



PREMIUM ULTRASTRETCH NEOPRENE

THICKNESS 3 MM | JUNIOR SIZES AVAILABLE | MIXED ULTRASPAN MATERIAL | >22° C >71.6° F | CE CERTIFICATION DIVING WETSUIT EN 14225-1:2017: D

MOREA

3 mm

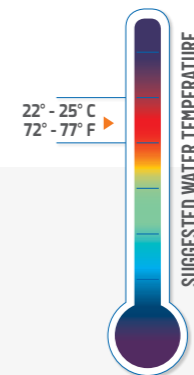

PREMIUM ULTRA STRETCH NEOPRENE ON ARMS

PREMIUM ULTRA STRETCH NEOPRENE ON LEGS

...FLEX Area

Cressi wetsuit designs guarantee complete adherence to the body, just like a second skin. The flex areas facilitate movement, ensuring complete comfort and ease of donning and motion, especially in the arm and ankle areas.

The Morea is a 3 mm neoprene one-piece wetsuit ideal for scuba diving, snorkeling, swimming, and other aquatic sports in warm waters. It is assembled using flat sewing with anti-fraying thread. The large neoprene panels optimize its natural elasticity and combine with an elastic nylon lining. With the goal of reducing water leaks, the dorsal YKK® zipper is equipped with an Aquastop® flap. Velcro® dorsal zipper closure. The ankle and wrist

finishes are completed using Overlock cuffs. It has an Anatomic Shape® preformed collar that complements the contours of the chest and neck with a super-elastic Ultraspan® lining and nylon lining mixed with Ultraspan® in the joint areas. Improving hydrodynamics, the elasticity guarantees a quick-dry when the suit is out of the water and exposed to the wind in aquatic activities like skiing, sailing, or surfing.

MAN

CODE	SIZE	CASE PACK
LU476002	S	5
LU476003	M	5
LU476004	L	5
LU476005	XL	5
LU476006	2XL	5

LADY

CODE	SIZE	CASE PACK
LU476501	XS	5
LU476502	S	5
LU476503	M	5
LU476504	L	5
LU476505	XL	5

TECHNICAL FEATURES

- 3-mm neoprene with Ultraspan ends on the arms and legs.
- Rubberized neoprene on the chest and protection on the knees.
- 20° ANATOMIC SHAPE NECK CLOSURE

WATERTIGHT SEALS

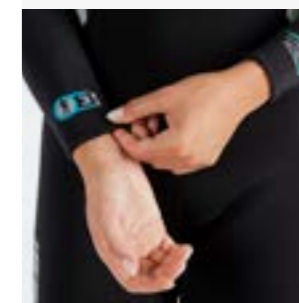

UNDER ZIP LINING



MIXED ULTRASPAN MATERIAL RUBBERIZED NEOPRENE ON THE CHEST

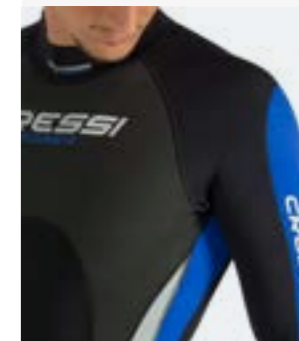

PROTECTION ON THE KNEES

HIGH STRETCH MATERIAL ON LEGS AND ARMS



MAYA

| 2.5 MM

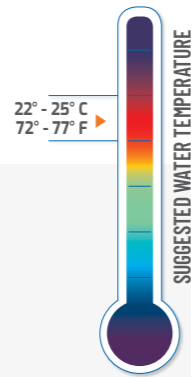

NeoPro-fit

Cressi wetsuit designs ensure a superior fit. NeoPro-fit combines a high level of erosion resistance and durability, along with superb elasticity and softness. We guarantee better performance and affordability.

TECHNICAL FEATURES

- One-piece full wetsuit
- 2.5 mm neoprene for warm water diving
- Provides protection from stinging sea life
- Easy donning and doffing
- Anatomic cut neck closure



All-in-one for temperate waters, hoodless, with long sleeves and pants, made from double lined 2.5 mm thick neoprene. To reduce water infiltration, the strong rear YKK zipper has an Aqua stop under the zip. The neck is watertight

thanks to a single-lined neoprene seal. Legs and sleeves finished with the simple, economic, and reliable Overlock cuff. The legs are pre-formed to guarantee easier kicking movement.

MAN

CODE	SIZE	CASE PACK
UV456001	S	5
UV456002	M	5
UV456003	L	5
UV456004	XL	5
UV456005	2XL	5
UV456006	3XL	5

LADY

CODE	SIZE	CASE PACK
UV456101	XS	5
UV456102	S	5
UV456103	M	5
UV456104	L	5
UV456105	XL	5
UV456106	2XL	5

I SHOULDER SIZE INDICATION

NeoPro-fit

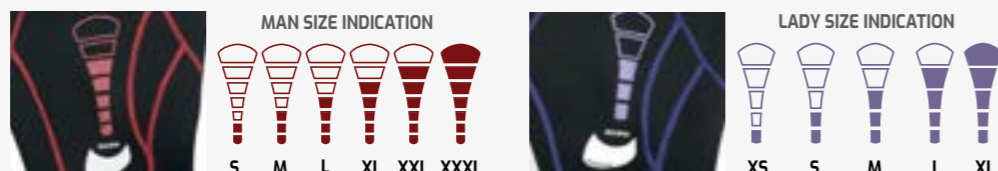

Cressi wetsuit designs ensure a superior fit. NeoPro-fit combines a high level of erosion resistance and durability, along with superb elasticity and softness. We guarantee better performance and affordability.



BAHIA FLEX

| 2.5 MM



22° - 25° C
72° - 77° F

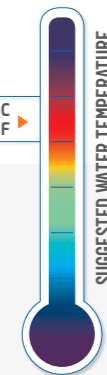

...FLEX Area

Cressi wetsuit designs guarantee complete adherence to the body, just like a second skin. The flex areas facilitate movement, ensuring complete comfort and ease of donning and motion, especially in the arm and ankle areas.

TECHNICAL FEATURES

- Front-zip full wetsuit
- YKK zipper
- Made of flexible double-lined Neoprene 3 mm thick
- Overlock stitching cuffs
- Reinforced knee areas



The Bahia Flex 3mm is the successor of the Bahia front-zip full wetsuit. This model is redesigned to ensure total freedom of movement and can be used in any water sport. The wetsuit features separate anatomical cuts for both men and women. The front-zip, made of metal YKK®, ensures ease of donning and doffing. The cut is designed to guarantee complete adherence to the body, just like a second skin. The Flex areas facilitate movement, ensuring complete

comfort. A small difference between thickness makes donning and movement easier, particularly in the arms and ankle areas. Cuff seals prevent water entry while swimming and the double-lined Neoprene resists compression at depth. The double-lining is more durable than the single-lining of other competitor's wetsuit. The knee and shin area is reinforced to protect the wetsuit against accidental scratches. The Aquastop wrist and ankle seals limit water exchange.

MAN

CODE	SIZE	CASE PACK
LV471001	XS	10
LV471002	S	10
LV471003	M	10
LV471004	L	10
LV471005	XL	10
LV471006	2XL	10
LV471007	3XL	10

LADY

CODE	SIZE	CASE PACK
LV472001	XS	10
LV472002	S	10
LV472003	M	10
LV472004	L	10
LV472005	XL	10
LV472006	2XL	10

LIDO LONG

| 2 MM

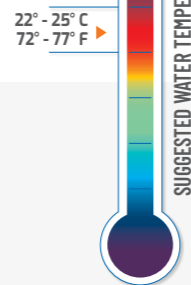

NeoPro-fit

Cressi wetsuit designs ensure a superior fit. NeoPro-fit combines a high level of erosion resistance and durability, along with superb elasticity and softness. We guarantee better performance and affordability.

TECHNICAL FEATURES

- Full front-zip wetsuit
- Double-lined neoprene for durability and warmth
- Anatomical cuts
- Quality YKK zipper for durability



The easy-entry, front zipper placement of the Lido makes it effortless to put on. It is perfect for snorkeling, diving in tropical waters, swimming, surfing and other activities. Highly flexible 2 mm Neoprene and a flattering cut conform easily to most body shapes for a

great fit. The absence of seams under the arms prevents the intrusion of water. Fabric cuts are anatomical for both men and women. The legs and sleeves are finished with a simple, economic, and reliable Overlock cuff.

MAN

CODE	SIZE	CASE PACK
LV452001	XS	10
LV452002	S	10
LV452003	M	10
LV452004	L	10
LV452005	XL	10
LV452006	2XL	10
LV452007	3XL	10

LADY

CODE	SIZE	CASE PACK
LV454001	XS	10
LV454002	S	10
LV454003	M	10
LV454004	L	10
LV454005	XL	10
LV454006	2XL	10

THICKNESS 2.5 MM JUNIOR SIZES AVAILABLE BACK ZIP >22° C >71.6° F CE CERTIFICATION DIVING WETSUIT EN 14225-1:2017: D

MED X NEW 2022

| 2.5 MM

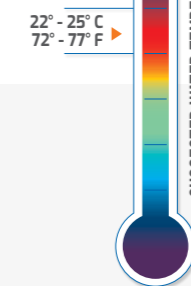

FLEX Area

Cressi wetsuit designs guarantee complete adherence to the body, just like a second skin. The flex areas facilitate movement, ensuring complete comfort and ease of donning and motion, especially in the arm and ankle areas.

TECHNICAL FEATURES

- Rear zip.
- Adjustable collar with Velcro closure.
- Children's sizes available.



This is the new version of the most known Cressi one-piece wetsuit for water sports and tropical seas. It's presented with a new pattern, and new captivating aesthetic. It's available in man, woman and kids version.

Monoshort without hook, with short pants and sleeves in double fodder neoprene 2.5mm.

It's ideal to snorkeling, swimming, tropical seas and any kind of water sport.

Flat neoprene on the chest area to obtain more elasticity. There are insertions in flat neoprene on wrists and legs to minimize water filtrations. YKK® 8 pitch dorsal zip with Velcro® closing.

MAN

CODE	SIZE	CASE PACK
XLV437081	XS	5
XLV437082	S	5
XLV437083	M	5
XLV437084	L	5
XLV437085	XL	5
XLV437086	2XL	5
XLV437087	3XL	5

LADY

CODE	SIZE	CASE PACK
XLV437591	XS	5
XLV437592	S	5
XLV437593	M	5
XLV437594	L	5
XLV437595	XL	5
XLV437596	2XL	5

TORTUGA

| 2.5 MM

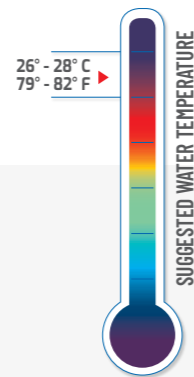

TECHNICAL FEATURES

- One-piece short wetsuit
- 2.5 mm neoprene for warm water diving
- Self donning back zipper with pull tab leash
- Anatomic cut neck closure
- Provides abrasion, exposure, UV protection

The Tortuga Man and Woman wetsuit is a one-piece shorty ideal for tropical waters. The wetsuit is made with 2.5mm double-lined neoprene, offering maximum comfort and thermal protection for all water sports. The back zipper closure is attached to a pull-tab leash to ease donning and doffing.

The suit's seams are sewn for strength and durability. This suit is perfect for tropical waters, swimming, sailing, and snorkeling, diving and water sports in general while offering UV protection to covered areas. This suit offers great range of movement and incorporates an adjustable Velcro fastener collar for maximum comfort.

NeoPro-fit

Cressi wetsuit designs ensure a superior fit. NeoPro-fit combines a high level of erosion resistance and durability, along with superb elasticity and softness. We guarantee better performance and affordability.

MAN

CODE	SIZE	CASE PACK
UV457001	XS	5
UV457002	S	5
UV457003	M	5
UV457004	L	5
UV457005	XL	5
UV457006	2XL	5
UV457007	3XL	5

LADY

CODE	SIZE	CASE PACK
UV457101	XS	5
UV457102	S	5
UV457103	M	5
UV457104	L	5
UV457105	XL	5
UV457106	2XL	5

I SHOULDER SIZE INDICATION



Cressi wetsuit designs ensure a superior fit. NeoPro-fit combines a high level of erosion resistance and durability, along with superb elasticity and softness. We guarantee better performance and affordability.



PLAYA FLEX

| 3 MM

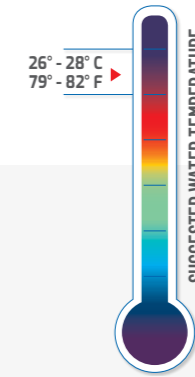

TECHNICAL FEATURES

- One-piece short wetsuit
- 2.5 mm double-lined high stretch ultraspan
- Ultra span neoprene decreases water exchange
- Provides UV protection
- Front-zip for easy donning and doffing

...FLEX Area

Cressi wetsuit designs guarantee complete adherence to the body, just like a second skin. The flex areas facilitate movement, ensuring complete comfort and ease of donning and motion, especially in the arm and ankle areas.

The Playa Flex is the successor of the Playa front-zip short wetsuit. The cut is designed to guarantee complete adherence to the body, just like a second skin. The Flex areas facilitate movement, ensuring complete comfort. A small difference between thickness makes donning and movement easier, particularly in the arms and ankle areas. The wetsuit features separate anatomical cuts for both men and women. This model is redesigned to ensure total freedom of movement and to be

used in any water sport. The front-zip, made of metal YKK®, ensures ease of donning and doffing. Divers will appreciate the high-quality double-lined Neoprene, which retains its shape and insulating ability at depth. The Playa Flex is perfect for snorkeling, diving in tropical water, swimming, sailing and all water sports in general. The arms and legs are made with an elastic Neoprene Ultraspan® braided seal to minimize water infiltration.

MAN

CODE	SIZE	CASE PACK
LV448001	XS	10
LV448002	S	10
LV448003	M	10
LV448004	L	10
LV448005	XL	10
LV448006	2XL	10
LV448007	3XL	10

LADY

CODE	SIZE	CASE PACK
LV449001	XS	10
LV449002	S	10
LV449003	M	10
LV449004	L	10
LV449005	XL	10
LV449006	2XL	10



THICKNESS 2 MM JUNIOR SIZES AVAILABLE FRONT ZIP

LIDO

| 2 MM

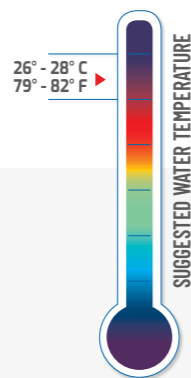

NeoPro-fit

Cressi wetsuit designs ensure a superior fit. NeoPro-fit combines a high level of erosion resistance and durability, along with superb elasticity and softness. We guarantee better performance and affordability.

TECHNICAL FEATURES

- Separate anatomical cuts for both men and women
- Double-lined neoprene for durability and warmth
- Front zip entry for easier donning



The easy-entry front zipper placement makes the Lido effortless to put on and is perfect for snorkeling, diving in tropical waters, swimming,

sailing, and other activities. Highly flexible 2 mm neoprene and a flattering cut conform easily to most body shapes for a great fit.

MAN

CODE	SIZE	CASE PACK
LV455001	X5	10
LV455002	S	10
LV455003	M	10
LV455004	L	10
LV455005	XL	10
LV455006	2XL	10
LV455007	3XL	10

LADY

CODE	SIZE	CASE PACK
LV457001	X5	10
LV457002	S	10
LV457003	M	10
LV457004	L	10
LV457005	XL	10
LV457006	2XL	10

UV 50+ PROTECTION

THICKNESS 1 MM 86% POLYESTER 14% SPANDEX FRONT ZIP

SKIN

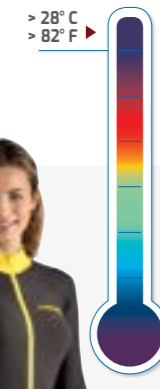

TECHNICAL FEATURES

- 86% polyester
- 14% spandex

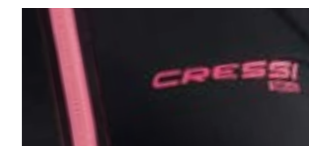
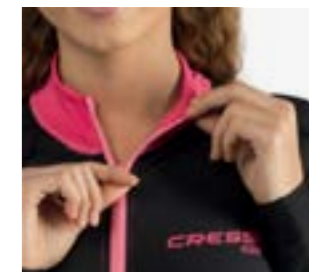

Crafted from nylon material, the Skin is a versatile and a must-have fullsuit for traveling divers. The high-stretch material is effortless to swim in and naturally conforms to the body to reduce drag. The Skin provides UV

protection on the surface and just the warmth needed for extended snorkeling or diving sessions in tropical waters. A long front zip makes the Skin easy to put on and the suit easily layers under thicker dive wear.

UNISEX

CODE	COLOR	SIZE	CASE PACK
WDG050102	Black/Yellow	S	10
WDG050103	Black/Yellow	M	10
WDG050104	Black/Yellow	L	10
WDG050105	Black/Yellow	XL	10
WDG050106	Black/Yellow	2XL	10
WDG050201	Black/Blue	X5	10
WDG050202	Black/Blue	S	10
WDG050203	Black/Blue	M	10
WDG050204	Black/Blue	L	10
WDG050205	Black/Blue	XL	10
WDG050206	Black/Blue	2XL	10
WDG050207	Black/Blue	3XL	10
WDG050401	Black/Pink	X5	10
WDG050402	Black/Pink	S	10
WDG050403	Black/Pink	M	10
WDG050404	Black/Pink	L	10
WDG050405	Black/Pink	XL	10
WDG050602	Black/Silver	S	10
WDG050603	Black/Silver	M	10
WDG050604	Black/Silver	L	10
WDG050605	Black/Silver	XL	10
WDG050606	Black/Silver	2XL	10
WDG050607	Black/Silver	3XL	10

NEOPRENE ACCESSORIES

SCUBA

MADE IN ITALY
MANUFACTURE
QUALITY SINCE
1956

Photo by: Luiss. Hoesler

100% HIGH STRETCH MATERIAL

SOLO FLEX

| MULTI-THICKNESS 7/5 MM



TECHNICAL FEATURES

- Made entirely of H5200 high stretch neoprene for exceptional comfort and fit
- 7mm H5200 high stretch neoprene cranium and 5mm H5200 high stretch skin-in neoprene face and neck seals
- Face area left unbound to allow for custom trimming
- Unique vent design releases air trapped at the top of the head
- Waterproof glued & blind stitched seams
- Hanging loop located at the top for easy drying
- Designed for use with drysuits
- Descriptive hang tag attached to hanging loop

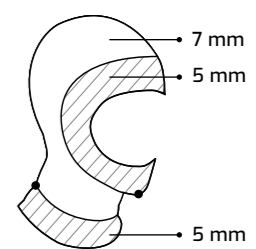

» For size chart see page 365

UNISEX

CODE	SIZE	CASE PACK
LW480202	XS/S	5
LW480203	M	5
LW480205	L/XL	5

SOLO

| 3/5 MM



UNISEX 3 mm

CODE	SIZE	STYLE	CASE PACK
LR108132	S	3 mm	10
LR108133	M	3 mm	10
LR108134	L	3 mm	10
LR108135	XL	3 mm	10

UNISEX 5 mm

CODE	SIZE	STYLE	CASE PACK
LR108102	S	5 mm	10
LR108103	M	5 mm	10
LR108104	L	5 mm	10
LR108105	XL	5 mm	10

SOLO

| NEOPRENE 2 MM

The Solo 2mm hood features a smooth neoprene seal along the outline of the face and on the chin area to limit the entrance of water. It also features double lined neoprene and adds extra warmth for colder water diving. The hood's contoured shape provides a better fit and the hood's seams are glued and flat lock stitched for added comfort.



UNISEX

CODE	SIZE	CASE PACK
LW480002	XS/S	10
LW480004	M/L	10
LW480006	2XL	10

HANDEX

Hood made with strong and elastic synthetic fabric. It protects the head and can be worn under a wetsuit or a rash guard. It is anti UV rays.



CODE	CASE PACK
LW480102	10

BEANIE

Hood made with strong and elastic synthetic fabric. It protects the head and can be worn under a wetsuit or a rash guard. It is anti U/V rays.



UNISEX

CODE	PRODUCT	CASE PACK
VA901000	BEANIE UNISEX w/ELASTIC CORD	10

TECHNICAL FEATURES

- Adjustable drawstring
- Elastic cord

FABRIC TYPE

- 80% Neoprene
- 20% Nylon



HIGH STRETCH GLOVES

| 2.5 MM | 3.5 MM | 5 MM

2.5 mm

CODE	SIZE	CASE PACK
LX475701	S	10
LX475702	M	10
LX475703	L	10
LX475704	XL	10

3.5 mm

CODE	SIZE	CASE PACK
LX475801	S	10
LX475802	M	10
LX475803	L	10
LX475804	XL	10

5 mm

CODE	SIZE	CASE PACK
LX475901	S	10
LX475902	M	10
LX475903	L	10
LX475904	XL	10



CRESSI USA FIT SIZE



5-finger gloves made from single-lined soft, high-stretch neoprene. The inside is covered in Metallite to make them easy to put on. The preformed shape favours the natural position of the hand, with semi-bent fingers. The entire surface is covered with a non-slip finish for a sure grip in all situations.

TROPICAL GLOVES

| 2 MM

Five fingered gloves 2 mm thick Neoprene, made from two different soft and light materials. The palm and finger area uses a light Gray Napa that becomes extraordinarily soft upon contact with the water. However, the upper part of the glove and the wrist area are made from very thin, supple neoprene.

A large area that corresponds to the upper side of the wrist allows for instant adjustment, both before and during the dive. These are particularly suitable gloves when you need the very best touch sensitivity in the fingers. The palm also offers good resistance to abrasions.

CODE	SIZE	CASE PACK
LX475301	S	10
LX475302	M	10
LX475303	L	10
LX475304	XL	10
LX475305	2XL	10



CRESSI USA FIT SIZE



THICKNESS GUIDE

| WETSUIT THICKNESS AND WATER TEMPERATURE

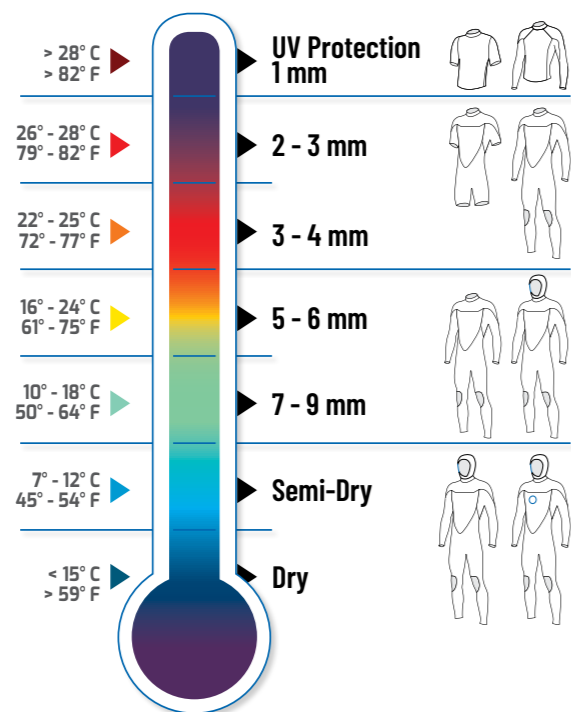

TECHNICAL FEATURES

- Wetsuit suitability may vary by 5° to 10° F based off the body strength.
- Level of activity, weight and outside temperature

ISLA

| 7 MM



WITH SOLES

CRESSI USA FIT SIZE



CODE	SIZE	CASE PACK
US051000	5	5
US051001	6	5
US051002	7	5
US051003	8	5
US051004	9	5
US051005	10	5
US051006	11	5
US051007	12	5
US051008	13	5

TECHNICAL FEATURES

- Built in fin strap holder
- Built in sole to provide extra comfort
- Super elastic neoprene to provide comfort
- Thickness of boot provides toughness while maintaining warmth

YKK ZIPPER



STRAP FIN HOLDER



POLYBAG

BALEARI PHS

| 6 MM | PROTECTIVE HARD SOLE



CRESSI USA FIT SIZE



TECHNICAL FEATURES

- **PHS:** Protective Hard Sole
- Feet protection against rocks and puncture
- Elastic 6mm Neoprene
- Side YKK zip for donning and doffing
- Fin strap holder on the back

CODE	SIZE	CASE PACK
ULX436551	5	5
ULX436552	6.5	5
ULX436553	7.5	5
ULX436554	9	5
ULX436555	10	5
ULX436556	11	5
ULX436557	12	5
ULX436558	13.5	5



POLYBAG

ISLA

| 5 MM



WITH SOLES

CRESSI USA FIT SIZE



CODE	SIZE	CASE PACK
US050000	5	5
US050001	6	5
US050002	7	5
US050003	8	5
US050004	9	5
US050005	10	5
US050006	11	5
US050007	12	5
US050008	13	5
US050009	14	5

TECHNICAL FEATURES

- Built in fin strap holder
- Built in sole to provide extra comfort
- Super elastic neoprene to provide comfort
- Thickness of boot provides toughness while maintaining warmth

YKK ZIPPER



STRAP FIN HOLDER



POLYBAG

BALEARI MD PHS

| 3 MM | PROTECTIVE HARD SOLE



Ideal for outdoor sports and travel. They feature a Hard Sole that protects the feet against sharp rocks. Made with Super Elastic Neoprene for best comfort within the sole, it is built to provide extra comfort, and is also ultra-durable. The back of the heel has a special design that fits perfectly with open heel fins for scuba diving.

The small boss is used to prevent the slipping of the fins strap. A strong non-slip molding covers the entire sole. They are suitable for surfing, kayaking, scuba diving and different kind of water sports.

CODE	SIZE	CASE PACK
ULX443551	5	5
ULX443552	6,5	5
ULX443553	7,5	5
ULX443554	9	5
ULX443555	10	5
ULX443556	11	5
ULX443557	12	5
ULX443558	13,5	5

CRESSI USA FIT SIZE



IBIZA

| 3 MM



TECHNICAL FEATURES

- Super elastic neoprene for best comfort
- Vulcanize rubber sole
- Sole built to provide extra comfort
- Ultra durable

CRESSI USA FIT SIZE



The Ibiza 3 mm are lightweight boots ideal for outdoor sports and travel. Made with Super Elastic Neoprene for best comfort within the sole, it is built to provide extra comfort, and is also ultra durable.

The back of the heel has a special design that fits perfectly with open heel fins for scuba diving. The small boss is used to prevent the slipping of the fins strap. A strong non-slip molding covers the entire sole. They are suitable for surfing, kayaking, scuba diving and different kind of water sports.

CODE	SIZE	CASE PACK
US435500	5	20
US435501	6	20
US435502	7	20
US435503	8	20
US435504	9	20
US435505	10	20
US435506	11	20
US435507	12	20
US435508	13	20
US435509	14	20

MINORCA LONG

| 3 MM



TECHNICAL FEATURES

- Super elastic neoprene for best comfort
- Vulcanize rubber sole
- Sole built to provide extra comfort
- Ultra durable

CRESSI USA FIT SIZE



YKK ZIPPER



STRAP FIN HOLDER



CODE	SIZE	CASE PACK
US040000	5	10
US040001	6	10
US040002	7	10
US040003	8	10
US040004	9	10
US040005	10	10
US040006	11	10
US040007	12	10
US040008	13	10
US040009	14	10



POLYBAG

MINORCA SHORT

| 3 MM



TECHNICAL FEATURES

- Super elastic neoprene for best comfort
- Vulcanized rubber sole
- Sole built to provide extra comfort
- Ultra durable

The Minorca Short 3mm are lightweight shoes ideal for outdoor sports and travel. Made with Super Elastic Neoprene for best comfort within the sole, it is built to provide extra comfort and

is also ultra durable. The sole is made of long-lasting rubber to avoid slipping on wet or smooth surfaces. They are suitable for surfing, kayaking, scuba diving and different kind of water sports.

CODE	SIZE	CASE PACK
US042000	5	20
US042001	6	20
US042002	7	20
US042003	8	20
US042004	9	20
US042005	10	20
US042006	11	20
US042007	12	20
US042008	13	20
US042009	14	20



POLYBAG

THICKNESSES AVAILABLE: 3-5 MM | SOFT HIGHLY ELASTIC NYLON-LINED NEOPRENE | SMOOTH SKIN NEOPRENE ANKLE | ANTI-SLIP GRIP SOLE

SARAGO NEW 2022

I THERMAL SOCKS
17 MM



SMOOTH SKIN NEOPRENE

ANTI-SLIP GRIP SOLE

These socks for fins with strap or foot pocket are made of soft highly elastic nylon-lined neoprene. They prevent heat loss and keep feet warm. The smooth skin neoprene on the ankle allows maximum adherence between the sock and the leg of the wetsuit, reducing the passage of water. The sole is entirely non-slip. The construction of the blind stitch seam further improves comfort and aesthetics.

CODE	SIZE	CASE PACK
XLX440700	2XS	10
XLX440701	XS	10
XLX440702	S	10
XLX440703	M	10
XLX440704	L	10
XLX440705	XL	10
XLX440706	2XL	10

PALMA LT

13 MM

These tall socks are great for either full foot or open heel fins. The socks are lightweight and a great addition to the traveling diver's gear bag. Socks are extremely comfortable equipped with a Rubber Grip Sole design to assist with Non-Slip on wet surfaces such as boat decks and slipper ladders. The Palma are built-to-last with glued-and-sewn seams for strength and durability.



CODE	SIZE	CASE PACK
US036002	XS	5
US036003	S/M	5
US036004	M/L	5
US036005	L/XL	5
US036006	XL/2XL	5

PALMA ST

13 MM

These short socks are great for either full foot or open heel fins. The socks are lightweight and a great addition to the traveling diver's gear bag. Socks are extremely comfortable equipped with a Rubber Grip Sole design to assist with Non-Slip on wet surfaces such as boat decks and slipper ladders.



CODE	SIZE	CASE PACK
US035002	XS/S	10
US035003	S/M	10
US035004	M/L	10
US035005	L/XL	10
US035006	XL/2XL	10

TECHNICAL FEATURES

- Grip design to assist with nonslip
- Super elastic neoprene for best comfort
- Ultra durable
- Lightweight, ideal for travel
- With Anti-slip sole

CRESSI USA FIT SIZE

Runs Small Runs Large

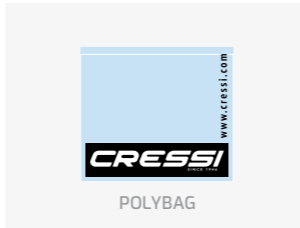

TECHNICAL FEATURES

- Grip design to assist with nonslip
- Super elastic neoprene for best comfort
- Ultra durable
- Lightweight, ideal for travel
- With Anti-slip sole

CRESSI USA FIT SIZE

Runs Small Runs Large

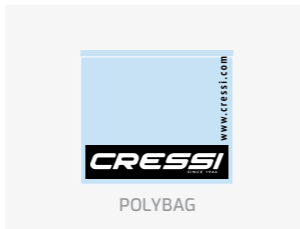

ANTI-SLIP

2.5 MM

SIZE	EU FOOT SIZE	US MEN'S FOOT SIZE	US WOMEN'S FOOT SIZE
S	36 / 38	5 / 6.5	6 / 7.5
M	39 / 40	7/8	8/9
L	41 / 43	9 / 10.5	10 / 11.5
XL	44 / 46	11 / 12.5	12 / 13.5

CODE	SIZE	CASE PACK
LX433001	S	10
LX433002	M	10
LX433003	L	10
LX433004	XL	10



POLYBAG

ULTRA STRETCH NEOPRENE

1.5 MM

SIZE	EU FOOT SIZE	US MEN'S FOOT SIZE	US WOMEN'S FOOT SIZE
S	36 / 38	5 / 6.5	6 / 7.5
M	39 / 40	7/8	8/9
L	41 / 43	9 / 10.5	10 / 11.5
XL	44 / 46	11 / 12.5	12 / 13.5

CODE	COLOR	SIZE	CASE PACK
XDF200120	Blue	S	10
XDF200121	Blue	M	10
XDF200122	Blue	L	10
XDF200123	Blue	XL	10
XDF200150	Black	S	10
XDF200151	Black	M	10
XDF200152	Black	L	10
XDF200153	Black	XL	10



POLYBAG

These are single-lined, thin, high stretch neoprene socks. The inner is lined in Metallite so they are easy to put on. The sole has an effective non-slip lining. They can be used with both closed foot fins for greater warmth and to protect the skin from scratches and chafing, as well as with firm-soled socks, using open-heel fins. In this case, warmth is considerably increased and it is also easier to put on your wetsuit.

CRESSI USA FIT SIZE

Runs Small Runs Large

Created in extremely supple, 1.5 mm thick, double-lined Ultraspan neoprene, these socks have non-slip and anti-wear soles and an Aquastop sealing single-lined neoprene at the top. They are perfect for all indoor and outdoor water sports thanks to the high protection and thermal function that they offer.

CRESSI USA FIT SIZE

Runs Small Runs Large

FIN SOCKS

SPANDEX

SIZE CONVERSION			
SOCK'S SIZE	EU SIZE	US MEN'S SIZE	US WOMEN'S SIZE
S/M	35/43	4 / 10.5	5 / 11.5
L/XL	44/47	11 / 13.5	12 / 14



NEW 2022

QUICK DRYING MATERIAL

Fin-socks are designed for people who live in their fins and need that perfect snug fit of a full foot fin. But also for people who seldom use fins or have sensitive feet. These socks are the solution that will allow you to wear your fins for hours without chafing your feet.

CRESSI USA FIT SIZE

Runs Small Runs Large

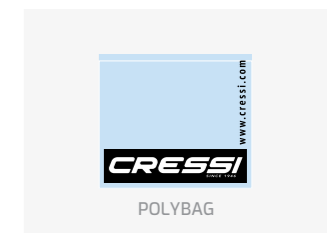

CODE	COLOR	SIZE	CASE PACK
USW030000B	Blue	S/M	10
USW031000B	Blue	L/XL	10
USW030000K	Black	S/M	10
USW031000K	Black	L/XL	10
XLX412001	Aquamarine	S/M	10
XLX412002	Aquamarine	L/XL	10
XLX412701	Lilac	S/M	10
XLX412702	Lilac	L/XL	10

600-DENIER TWISTED POLYESTER FILAMENT | WATER REPELLANT MATERIAL | YKK ZIP | PVC LAMINATION

JUMBO

| 600-DENIER TWISTED | POLYESTER FILAMENT | YKK ZIP

140 LITERS



TECHNICAL FEATURES

- PVC lamination
- Water-repellent coating

TWO-POSITION TELESCOPIC HANDLE



TWO-POSITION TELESCOPIC HANDLE



ANATOMIC SHOULDER STRAPS



HIGHLY RESISTANT WHEELS



The Jumbo bag is designed for very demanding divers who want to transport of all the equipment they need for their dives during their holiday travels or free time.

The ample volume (140 liters) and internal partitioning makes luggage easy to prepare. The two side pockets, with the fin logo inside, can hold a pair of large fins, up to size XXL. The two front pockets are handy for packing accessories, like towels, t-shirts and sunglasses.

The top pocket protects the two-position telescopic handle and also conceals a special small pocket inside for a personal details card. The spacious inside compartment has room to organize all technical equipment

up to size XXL (e.g. a complete 7 mm hooded wetsuit, jacket, boots, gloves, mask, mouthpiece, regulator, etc.), securing it with two special straps.

The system of buckles on the outside allows the bag to be compacted further, by pulling on the straps according to how much is packed in it.

The large wheels are highly resistant and easily replaceable, as they are attached with screws and locknuts.

The shoulder straps can be easily concealed in the back pocket and pulled out when needed. The new adjustment buckles on the shoulder straps allow rapid adjustment, even with the bag on the back.

CODE	CASE PACK
UB932500	1

	BAG DIMENSION (LENGTH-WIDTH-HEIGHT)		VOLUME		WEIGHT	
	CM	IN	LITER	CU FT	KG	LB
JUMBO	50 x 35 x 80	19 3/4 x 13 3/4 x 31 1/2	140	4.9	4,5 kg	9 lb 15 oz

BAGS

SCUBA

MANUFACTURED WITH QUALITY SINCE 1946

CRESSI SINCE 1946

YKK ZIP EXTRA POCKETS

MOBY 5 & MOBY 5 HYDRO



115 LITERS

MOBY 5 HYDRO

MOBY 5

Large wheeled luggage ideal to carry scuba diving equipment and other water activity gear. Made of 300 and 400 Denier fabric that is light and very strong with a good looking waterproof coating. The main compartment opens on three sides allowing easy access. There are two large bellows pockets in the front with zip closures, two side pockets for fins and a small upper pocket that holds an address tag. There are also two adjustable, padded, straps for carrying on the back that can be placed

in special pockets when the backpack is being wheeled. The reinforced pull handle is telescopic and fully retractable. The wheels have a large diameter and can be removed and easily replaced in the event of breakage. There are two carrying handles: a reinforced one at the top and one with Velcro closure at the bottom. The back of the bag houses supporting rods to keep the bag in a vertical position. All the zips are very strong YKK.

CODE	CASE PACK
UB932200	1
XUB932256	1

BAG DIMENSION (LENGTH-WIDTH-HEIGHT)			
	CM		IN
MOBY 5	40 x 28 x 76 h		15 1/2 x 11 x 30 h
MOBY 5 hydro	40 x 28 x 76 h		15 1/2 x 11 x 30 h
VOLUME		WEIGHT	
LITER	CU FT	KG	LB
115	4.06	3.9 kg	8 lb 10 oz
115	4.06	5.1 kg	11 lb 4 oz

COMPARTMENT DIMENSIONS		
Volume	115 L 4.06 cu ft	
Weight	Moby 5 3.9 kg 8 lb 10 oz	Moby 5 Hydro 5.1 kg 11 lb 4 oz
Main compartment	76 x 40 x 28 cm 30 x 15.8 x 11 in	
Upper front pocket	34.4 x 23 x 8.5 cm 13.5 x 9.05 x 3.3 in	
Lower front pocket	34 x 38 x 8.5 cm 13.4 x 15 x 3.3 in	
Fin pocket	73 x 25 x 7 cm 28.7 x 9.8 x 2.8 inch	

TECHNICAL FEATURES

- Made of 300 and 400 Denier fabric with waterproof coating
- 2 large bellows pockets
- 2 long side pockets that can hold a pair of fins

WIDE FRONT POCKET



ADJUSTABLE SHOULDER



YKK ZIP



HEAVY-DUTY WHEELS



PIPER

The Piper is a suitcase designed and especially convenient for air travel, with a special 2 stage telescoping handle and 2 exterior compression straps with quick-release buckles. Several zippers, heavy-duty wheel housing, bumper protection, and scratch-resistant denier fabric ensure that your equipment will be able to be stored safely. Grab handles on the top, side, and bottom of the suitcase make this very easy to hold.

49 LITERS



The interior of the Piper features compression straps and a side pocket to help organize your belongings. A back ID pocket makes it possible to label your suitcase. At 2.9 kg | 6.4 lb and 4.9 liters

| 1.73 cubic feet of capacity, the Piper is light and great for traveling. Its dimensions are compliance with the carry-on airplane regulations: 35.5 x 23 x 56 cm | 14 x 9 x 22 in.

CODE	CASE PACK
UB952000	2

	DIMENSION (LENGTH-WIDTH-HEIGHT)		VOLUME		WEIGHT	
	CM	IN	LITER	CU FT	KG	LB
PIPER	35.5 x 23 x 56 h	14x9x22 h	49	1.73	2.9 kg	6 lb 6 oz

TECHNICAL FEATURES

- Book-style opening
- 2-stage telescoping handle
- 2 exterior compression straps with quick-release buckles
- Top pocket with zipper
- Central lock point zipper for pickpocket protection
- Heavy-duty wheel housing and bumper protection
- Grab handles on top, side and bottom for easy grab-and-go
- Interior compression straps and side pocket for organization
- Internal mesh compartment with zipper
- Robust wheels for multi-terrain maneuverability
- Back ID pocket
- Scratch-resistant Denier fabric
- Only 6 lb weight
- Front-zip for easy donning and doffing

COMPRESSION STRAPS WITH QUICK-RELEASE BUCKLES STRAPS



TOP POCKET WITH ZIPPER



ROBUST WHEELS FOR MULTI-TERRAIN MANEUVERABILITY



WATERPROOF POLYESTER | EXTERNAL WATERPROOF POCKET

TUNA DRY

| WHEELED OVERSIZED BAG

120 LITERS



The Tuna Dry Wheel Bag is an ideal bag for transporting any kind of equipment for water activities keeping protected from water. It has a capacity of 120 liters | 4.23 cu ft that can fit also long freediving fins. Made of highly resistant materials, it allows you to keep your equipment dry and protect electronic devices. Equipped with central handles/shoulder straps and side handles to facilitate transport even though the presence of wheels. The presence of wheels facilitates transport even on long routes. Equipped with

practical central handles/shoulder straps and reinforced side handles. A practical waterproof side pocket keeps small items dry and protects electronic devices. Internal straps with clip closure allow you to secure the sports equipment during transport. Made of very resistant materials, with well-finished stitching. The lower part is reinforced, shockproof and insulating. Waterproof seal. Keep your equipment dry, protect electronic devices and documents from water, dust, and sand.

CODE	CASE PACK
XUB976200	2

	DIMENSION (LENGTH-WIDTH-HEIGHT)			VOLUME		WEIGHT	
	CM	IN		LITER	CU FT	KG	LB
TUNA	40 x 41 x 95	37 1/2 x 15 3/4 x 16 1/8		120	4.23	3.5 kg	7 lb 11 oz



TECHNICAL FEATURES

- Made of polyester
- External pocket
- Side handles and shoulder straps

INSIDE STRAPS



WITH WHEELS



SEMI RIGID CASE



OCTOPUS

| DRY BACKPACK

30 LITERS



The Octopus is a Dry Bag of 30 liters capacity full of accessories. It features 2 adjustable shoulder straps completed with D-Rings allowing to attach other kinds of equipment. On the left side, there is an adjustable hand strap with 2 other d-rings. On the right side, there are handles allowing to attach other equipment and tools like carabiners. It is

ideal for protecting your equipment from the water when sailing or in a boat. It can be used also for carrying wet equipment like scuba diving wetsuit and snorkeling gear to avoid wetting other things like the car trunk. The seams are made with Seamless technology (high-frequency welded) and with a completely watertight closing system.

CODE	CASE PACK
XUB976000	10

	DIMENSION (DIAMETER-HEIGHT)		VOLUME		WEIGHT	
	CM	IN	LITER	CU FT	KG	LB
OCTOPUS	Ø 23 x 54	Ø 9 x 21 1/2	30	1.06	660 kg	1 lb 7 oz

TECHNICAL FEATURES

- Capacity: 30 liters | 1.06 cu ft
- Top dry closure with quick-release buckles
- Adjustable shoulder straps with D-rings
- Left side handle with D-rings
- Right side handles for accessories
- High-frequency seamless welding technology
- Fully waterproof bag

TOP DRY CLOSURE WITH QUICK-RELEASE BUCKLES



LEFT SIDE HANDLE WITH D-RINGS



ADJUSTABLE SHOULDER STRAPS WITH D-RINGS

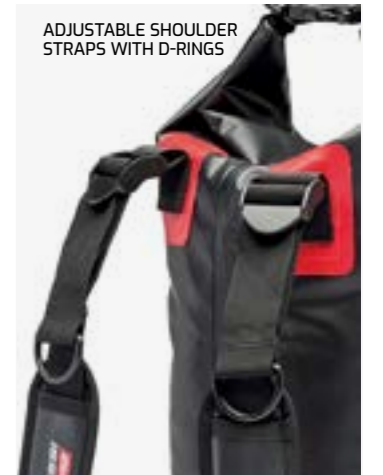

DRY BAG

FINESTRA DRY BAG DRY BAGS



The Dry Bags are designed for boating and water sports. They're made in high quality resistant soft touch material. It is possible to easily pack inside another bag for transport. Bags have electronically (RF) welded seams that make the bag 100% waterproof. This proven design provides all-purpose, reliable

protection for your gear. Bags have a roll top closure with a squeeze-style side-release buckle. When buckle is fastened, the roll top provides a carry handle for easy transport. Bags are also equipped with easily adjustable shoulder straps.

CODE	COLOR	SIZE	CASE PACK
UA955010	Black/Finestra	10 liters	10
UA935705	Black/Silver	5 liters	10
UA935710	Black/Silver	10 liters	10
UA935715	Black/Silver	15 liters	10
UA935720	Black/Silver	20 liters	10

	DIMENSION (DIAMETER-HEIGHT)		VOLUME		WEIGHT	
	CM	IN	LITER	CU FT	KG	LB
DRY BAG 20L	Ø 23 x 43	Ø 9 x 17	20	0.71	480 g	16.9 oz
DRY BAG 15L	Ø 23 x 34	Ø 9 x 13 1/2	15	0.53	350 g	12.3 oz
DRY BAG 10L	Ø 19 x 36	Ø 7 1/2 x 14 1/8	10	0.35	320 g	11.3 oz
DRY BAG 5L	Ø 19 x 28	Ø 7 1/2 x 11	5	0.18	255 g	9 oz



TECHNICAL FEATURES

- Made in waterproof fabrics with electric resistance welding
- **Models:** 10L and 15L version: one adjustable shoulder strap
- **20L:** robust side handle and back pack
- Shoulder straps

ROLL TOP CLOSURE



SIDE RUBBERIZED HANDLE



ADJUSTABLE SHOULDER STRAP



SYSTEM ROLL TOP CLOSER



ROATAN

| 600 DENIER



90 LITERS



The Roatan mesh liter bag is perfect to keep all your scuba gear together. Made with high-density polyester, this mesh bag makes carrying your gear easy. The bag is equipped with two access points - a drawstring on the top and a full-length zipper on the side - to make retrieving equipment easy, even if wet. The bag can be worn like a backpack, with padded, adjustable shoulder straps and

chest strap. It can also be carried with two reinforced handles, one on the side and one on the top.

Included is a semi-dry front pocket with a zipper closure. A drain in the reinforced PVC bottom ensures that any water empties out, making this a perfect option to rinse your gear after use.

CODE	CASE PACK
UB936000	10

	DIMENSION (DIAMETER-HEIGHT)		VOLUME		WEIGHT	
	CM	IN	LITER	CU FT	KG	LB
ROATAN	Ø 39.5 - 72	Ø 15 - 28	90	3.18	1.2 kg	2 lb 10 oz

TECHNICAL FEATURES

- Front semi-dry pocket with zipper closing
- Anatomical adjustable shoulder straps and chest strap
- Reinforced top and side handles
- **Top closure:** drawstring closing with fastener
- **Side Closure:** full-length, double-enforced zipper
- Drain on bottom of the bag
- **Materials:** 600 Denier - High Density Polyester and 4 needle PVC mesh
- **Height:** 28.5 in with a diameter of 16 in
- **Capacity:** 3.18 Cu ft | 90 liters

SEMI DRY- FRONT POCKET



PADDED, ADJUSTABLE SHOULDER STRAPS



DRAWSTRING ON THE TOP



CHEST STRAP



UTILA

| 1680 DENIERG



85 LITERS



The Utila mesh liter bag is perfect for water sports lovers on the go. Made with high-density polyester, this wire mesh bag makes carrying your gear easy.

The bag is equipped with a drawstring on the top to make retrieving equipment easy, even if wet. The bag can be worn like a backpack,

with padded, adjustable shoulder straps and chest strap.

The Utila folds up into a small, compact case with a padded carrying handle for easy packing and transportation.

Included is a front semi-dry pocket with a zipper closure. shoulder straps.

CODE	CASE PACK
UB937000	20

	DIMENSION (DIAMETER-HEIGHT)		VOLUME		WEIGHT	
	CM	IN	LITER	CU FT	KG	LB
UTILA	ø 38.5 - 70	ø 15 - 27	85	3.00	1.1 kg	2 lb 7 oz

TECHNICAL FEATURES

- Lightweight mesh backpack
- Front semi-dry pocket with zipper closing
- Easily foldable into itself for storage
- Anatomical adjustable shoulder straps
- **Top closure:** drawstring closing with fastener
- **Side Closure:** double-enforced zipper
- Soft-padded handle included for carrying
- Air vent hole in the bottom to facilitate drying
- **Materials:** 1680 Denier - High Density Polyester and Hexagonal wire mesh
- **Height:** 29 in with a diameter of 15.5 in
- **Capacity:** 3 cu ft | 85 liters

BACK VIEW



PADDED, ADJUSTABLE SHOULDER STRAPS



GORGONA

107 LITERS



The Cressi Gorgona is great for hauling virtually any dive equipment, even the heavy stuff. The duffel-style mesh bag is made of durable 70% polyester mesh and 30% 600-D polyester PUX2 material that lets water drain easily. Roomy enough and strong enough for a full set of gear, it is an ideal gear-hauler for live-aboard use or for carrying dive suits separately. The mesh bag is also excellent for carrying rental equipment when resort diving. It folds compactly into a round bag with handle and is easy to store in your suitcase or main dive

bag, ready when you need it. Bag is equipped with YKK zippers. Padded full wrap-around carry handles make hefting the load that much easier. The great thing about a mesh bag is that when you get to the wash tank on the dock after a day-of-diving you can submerge the entire bag in the tank and rinse your gear while still-in-the-bag. You can then let the gear drip-dry on the way home or back in the hotel shower when on vacation. The Gorgona dimensions are long enough to pack even the longest freediving fins.

CODE	CASE PACK
UA925900	5

	DIMENSION (DIAMETER-HEIGHT)		VOLUME		WEIGHT	
	CM	IN	LITER	CU FT	KG	LB
GORGONA	ø 38x96	ø 15x 37 3/8	107	3.78	750 g	1 lb 10 oz

TECHNICAL FEATURES

- Travel mesh bag practical to carry or rinse the equipment
- The length is sized to house even the longest freediving fins
- Bag easily foldable for becoming a practical round bag with handle
- **Fabric:** 70% polyester mesh, 30% 600D polyester PUX2



CRESSI ROADS



ROADS TRAVEL

ROADS MESH

CRESSI VENTURE



EQUIPMENT BAGS

NET BAG



DIMENSIONS: Height: 75 cm, 29.5 in Width: 27.5 cm, 10.8 in
The Net Bag with drawstring closure with barrel lock fastener is ideal for carrying long fins and snorkeling equipment. The net style mesh allows to rinse the fins while still in the bag and hang to drip dry after use.

CODE
BZ175003

COMBO BAG



DIMENSIONS: Height: 51.2 cm, 20.2 in Width: 24.1 cm, 9.5 in
The Combo Bag has a nice design and features a durable plastic front to see the content. Velcro closing and handle for easy carrying.

CODE
US450032



51WE
MANUFACTURE
QUALITY SINCE
1946

METAL BEZEL	PROTECTION ALGORITHM FROM TARAVANA	LONG-LIFE BATTERY	4 OPERATIVE MODES	MINERAL GLASS	SILICONE STRAP WITH POLYAMIDE CORE
-------------	------------------------------------	-------------------	-------------------	---------------	------------------------------------



KING NEW 2022

| FREEDIVING COMPUTER WATCH

With a case diameter of only 48 mm and a highcontrast display of 35 mm, King is an extremely compact watch-computer specific for freediving. This innovative product boasts an algorithm developed in Cressi, which protects the freediver from the risk of Taravana, and a function that avoids the risk

of pulmonary edema. Mineral glass, heavy duty case with steel buttons for resistance to water pressure up to 120 m | 393 ft, metal bezel in AISI 316 steel with surface treatment and Inkkilled strap to prevent tears and breakage) with stainless steel buckle.



CODE	COLOR	CASE PACK
K5842020	Blue	4
K5842050	Black	4
K5842085	Orange	4



TARAVANA PROTECTION ALGORITHM

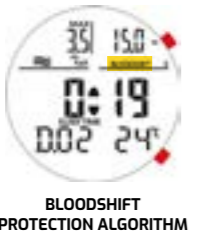

BLOODSHIFT PROTECTION ALGORITHM



TIDE LEVEL INDICATOR



SINGLE DIP LOGBOOK

TECHNICAL FEATURES

- High contrast display
- Easy access menu
- 12/24 time format with calendar and seconds
- Precision stopwatch
- Timer (countdown)
- Second time setting
- Alarm clock
- Backlit display
- Tide indicator
- Low battery indicator
- Metric or imperial units
- Long-lasting battery
- Sleep mode to increase battery life
- Battery replaceable by user
- FREE (FREEDIVING) PROGRAM**
- Taravana risk reduction algorithm with 8 levels
- Pulmonary edema risk reduction function with approach dive calculation
- Display of all diving parameters
- Depth
- Temperature
- Dip counter
- Maximum dive depth
- Dive time
- Length of surface interval between each dive
- Length of diving session
- Maximum descent and ascent speed indication
- Depth, dive time and surface interval alarms
- Recovery time alarm
- Hydration alarm
- Alarms that can be set at dive phase
- Fresh/salt water setting
- Lock mode for snorkeling or swimming activities
- LOGBOOK**
- Variable data logging interval
- Available during the diving session
- Indication of session parameters and of each dive
- INTERFACE**
- Optional with visualisation of diving profile



SILICONE PROTECTIVE LENS INCLUDED



ELITE CASE INCLUDED



ACCESSORIES

CODE	PRODUCT
KZ810000	STRAP EXTENDER for DIVE-WATCH COMPUTER - BLACK/BLACK
K5890000	SILICONE SCREEN PROTECTOR for DIVE WATCH
K5822001	BT INTERFACE for DIVE-WATCH COMPUTER
KZ700000	ELITE PROTECTIVE CASE for DIVE COMPUTER

SPARE PARTS

CODE	PRODUCT
KZ842050	SILICONE WATCHBAND - BLACK for KING
KZ842020	SILICONE WATCHBAND - BLUE for KING
KZ842085	SILICONE WATCHBAND - ORANGE for KING
KZ820094	BATTERY KIT (CR2450 + O-RING) for CARTESIO/GOA/NEON/NEPTO
KZ805099	SCREWS w/ NUT (1 pair) for DIVE WATCH COMPUTER BAND

- MINERAL GLASS
- HEAVY DUTY CASE
- PROTECTION ALGORITHM FROM TARAVANA
- EDEMA PROTECTION FUNCTION
- USER FRIENDLY MENU
- LONG-LIFE BATTERY



NEPTO

| FREEDIVING WATCH COMPUTER

With a case diameter of only 48 mm and a high-contrast display of 35 mm, Nepto is an extremely compact watch-computer specific for freediving.

This innovative product boasts an algorithm developed in Cressi, which protects the freediver from the risk of Taravana, and a function that avoids the risk of pulmonary edema. Mineral glass, heavy duty case with steel buttons for resistance to water pressure up to 120 m | 393 ft, rubber strap with stainless steel buckle.



BLUE BLACK GREEN

CODE	COLOR	CASE PACK
K5841020	Blue	4
K5841050	Black	4
K5841098	Green	4



TARAVANA PROTECTION ALGORITHM



BLOODSHIFT PROTECTION ALGORITHM



TIDE LEVEL INDICATOR



SINGLE DIP LOGBOOK

TECHNICAL FEATURES

- High contrast display
- Easy access menu
- 12/24 time format with calendar and seconds
- Precision stopwatch
- Timer (countdown)
- Second time setting
- Alarm clock
- Backlit display
- Tide indicator
- Low battery indicator
- Units in Metric or Imperial system
- Long-lasting battery
- Sleep mode to increase battery life
- Battery replaceable by user
- Long-lasting battery: CR2450 3V lithium

FREE (FREEDIVING) PROGRAM

- Taravana risk reduction algorithm with 8 levels
- Pulmonary edema risk reduction function with approach dive calculation
- Display of all diving parameters
- Depth
- Temperature
- Dive calculator
- Maximum dive depth
- Dive time
- Length of surface interval between each dive
- Length of diving session
- Maximum descent and ascent speed indication
- Depth, dive time and surface interval alarms
- Recovery time alarm
- Hydration alarm
- Alarms that can be set at dive phase
- Fresh/salt water setting
- Lock mode for snorkeling or swimming activities

LOGBOOK

- Variable data logging interval
- Available during the diving session
- Indication of session parameters and of each dive

INTERFACE

- Optional with Visualization of diving profile.

- » PROTECTION ALGORITHM FROM TARAVANA
- » EDEMA PROTECTION FUNCTION
- » USER FRIENDLY MENU
- » LONG-LIFE BATTERY



PACKAGING



OPTIONAL ACCESSORIES

| STRAP EXTENDER | SILICONE PROTECTIVE LENS | BT INTERFACE



ACCESSORIES

CODE	PRODUCT
KZ810000	STRAP EXTENDER for DIVE-WATCH COMPUTER - BLACK/BLACK
K5890000	SILICONE SCREEN PROTECTOR for DIVE WATCH
K5822001	BT INTERFACE for DIVE-WATCH COMPUTER
KZ700000	ELITE PROTECTIVE CASE for DIVE COMPUTER

SPARE PARTS

CODE	PRODUCT
KZ840020	WATCHBAND - BLACK/BLUE for NEON/NEPTO
KZ840055	WATCHBAND - BLACK/BLACK for NEON/NEPTO
KZ841098	WATCHBAND - BLACK/GREEN for NEPTO
KZ820094	BATTERY KIT (CR2450 + O-RING) for CARTESIO/GOA/NEON/NEPTO
KZ805099	SCREWS w/ NUT (1 pair) for DIVE WATCH COMPUTER BAND







GARA TURBO CARBON NEW 2022

| 29 DEGREE ANGLED INTERCHANGEABLE BLADE SYSTEM



TECHNICAL FEATURES

- Excellent propulsive performance
- 29 degree angled interchangeable carbon blade
- Modular detachable fin
- Superior performance
- Superior comfort
- Self adjusting foot pocketdiving even during desaturation



Following the Impulse project, we have successfully transferred the same design parameters for S-shaped undulating deformation to this innovative carbon fin. This particular movement permits a notable accumulation of elastic potential energy in the blade, which is released in the return kick, transforming into thrust. The effect has been achieved using a finite element program that enables the performance offered by carbon fiber to be exploited to the full. The blade is all-carbon-fiber with an angle of 29°. The fiber is imported from Japan. The shaped and processed sheet is then produced in a specialist plant in Turkey.

The blade is subsequently finished with an industrial co-molding process at Cressi's Genoa plant. The elevated chemical bonding achieved between blade and rail, effectively creating a single piece, has permitted the elimination of the rigid glue that prevented the carbon fiber blade from flexing naturally. The thermoplastic rubber used for the water channeling rails is extremely flexible and soft so as not to undermine the intrinsic characteristics of the carbon fiber. The blade is, therefore, less fragile and more protected by the rubber. The end result is a very light fin, which manages to exploit the maximum flexion of the carbon in every square millimeter.

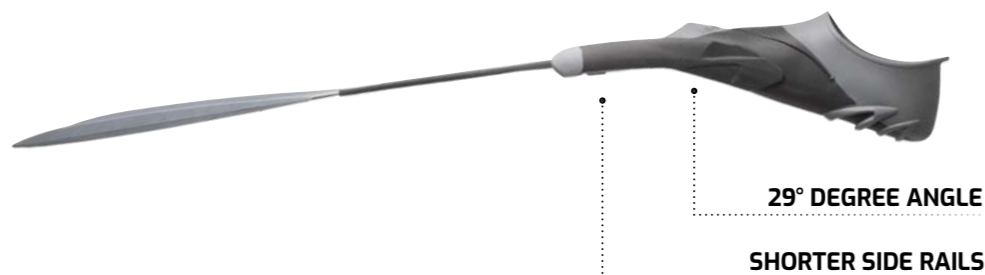

GARA MODULAR INSOLE INCLUDED

The insole for Gara Modular fins is recommended for use with thin socks in temperate waters because it improves the kick performance. The semi-rigid material of the insole is completely recycled. The insoles are supplied as a pair (right and left foot) and can be cut into their shape in three different sizes, according to pre-printed guidelines.

- Down-size Gara Fins foot pocket preformed sole
- Easily adjust size
- Non-corrosive plastic construction



CODE	SIZE	CASE PACK
BH165036	36/37	3
BH165038	38/39	3
BH165040	40/41	3
BH165042	42/43	3
BH165044	44/45	3
BH165046	46/47	3



ACCESSORIES

CODE	PRODUCT
BZ175032	RUBBER FIN KEEPER (PAIR) - BLACK (S)
BZ175033	RUBBER FIN KEEPER (PAIR) - BLACK (M)
BZ175034	RUBBER FIN KEEPER (PAIR) - BLACK (L)
BZ180022	INSOLE FOR GARA FIN

SPARE PARTS

CODE	PRODUCT
BZ180020	GARA MODULAR ASSEMBLY KIT
BH015036	GARA MODULAR TURBO FOOT POCKET [36/37]
BH015038	GARA MODULAR TURBO FOOT POCKET [38/39]
BH015040	GARA MODULAR TURBO FOOT POCKET [40/41]
BH015042	GARA MODULAR TURBO FOOT POCKET [42/43]
BH015044	GARA MODULAR TURBO FOOT POCKET [44/45]
BH015046	GARA MODULAR TURBO FOOT POCKET [46/47]

FIT SIZE



To maximize performance and comfort, wear fins with:

<input checked="" type="checkbox"/>	<input checked="" type="checkbox"/>	<input type="checkbox"/>	<input type="checkbox"/>
BARE FOOT	NEOPRENE SOCKS	3MM 5MM 7MM NEOPRENE BOOTS	3MM 5MM 7MM HARD SOLE BOOTS

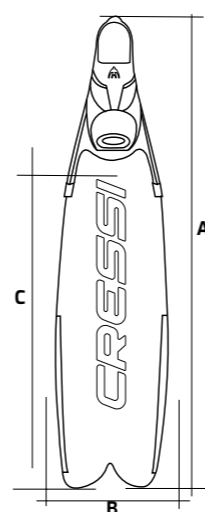

FIN SIZE	PRODUCT DIMENSION CHART			FIN HEIGHT FIT	SIZE CONVERSION CHART			
	A LENGTH	B WIDTH	C BLADE		EU FOOT SIZE	UK FOOT SIZE	US MEN'S FOOT SIZE	US WOMEN'S FOOT SIZE
36/37	*671 mm 26.4 in"	*215 mm 8.5 in"	*430 mm 16.9 in"	*83 mm 3.3 in"	36 / 37	3 / 4	4 / 5	5 / 6
37/38	*683 mm 26.9 in"	*215 mm 8.5 in"	*430 mm 16.9 in"	*84 mm 3.3 in"	37 / 38	5 / 6	6 / 7	7 / 8
39/40	*700 mm 27.6 in"	*215 mm 8.5 in"	*430 mm 16.9 in"	*87 mm 3.4 in"	39 / 40	6.5 / 7	7.5 / 8	8.5 / 9
41/42	*712 mm 28.0 in"	*215 mm 8.5 in"	*430 mm 16.9 in"	*92 mm 3.6 in"	41 / 42	8 / 9	9 / 10	10 / 11
43/44	*725 mm 28.5 in"	*215 mm 8.5 in"	*430 mm 16.9 in"	*97 mm 3.8 in"	43 / 44	10 / 10.5	11 / 11.5	12 / 12.5
45/46	*734 mm 28.9 in"	*215 mm 8.5 in"	*430 mm 16.9 in"	*103 mm 4.1 in"	45 / 46	11 / 12	12 / 13	13 / 14

⚠ FINNS COULD COME LABELED WITH EU AND UK SIZES ONLY

CRESSI'S SIZE CHART IS TO BE USED AS A REFERENCE ONLY



GARA TURBO IMPULSE NEW 2022

| 29 DEGREE ANGLED INTERCHANGEABLE BLADE SYSTEM



TECHNICAL FEATURES

- Extremely thin and light blade in compound made of elastomerized technopolymers developed by Cressi
- Stringer consisting of technopolymers with elastomeric loads with high flexural modulus
- Footpocket / blade angle of 29 degrees
- Modular detachable fin
- Superior performance
- Superior comfort
- Self adjusting foot pocket

GARA TURBO FOOT POCKET



GARA MODULAR INSOLE INCLUDED

The insole for Gara Modular fins is recommended for use with thin socks in temperate waters because it improves the kick performance. The semi-rigid material of the insole is completely recycled. The insoles are supplied as a pair (right and left foot) and can be cut into their shape in three different sizes, according to pre-printed guidelines.

- Down-size Gara Fins foot pocket preformed sole
- Easily adjust size
- Non-corrosive plastic construction



Following the Impulse project, we have successfully transferred the same design parameters for S-shaped undulating deformation to this innovative fin. This particular movement permits a notable accumulation of elastic potential energy in

the blade, which is released in the return kick, transforming into thrust.

The thermoplastic rubber used for the water channeling rails is extremely flexible and soft so as not to undermine the intrinsic characteristics of the blade.

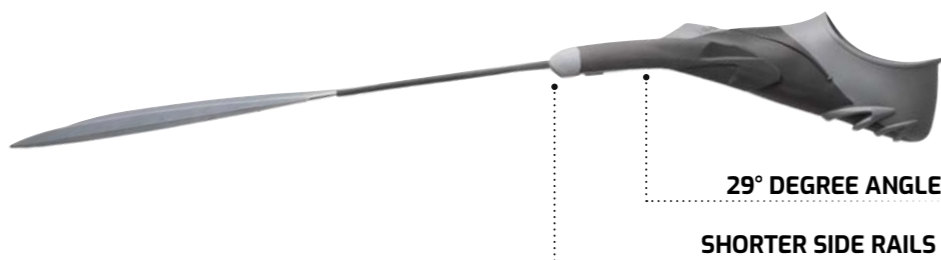

CODE	SIZE	CASE PACK
BH155036	36/37	3
BH155038	38/39	3
BH155040	40/41	3
BH155042	42/43	3
BH155044	44/45	3
BH165046	46/47	3

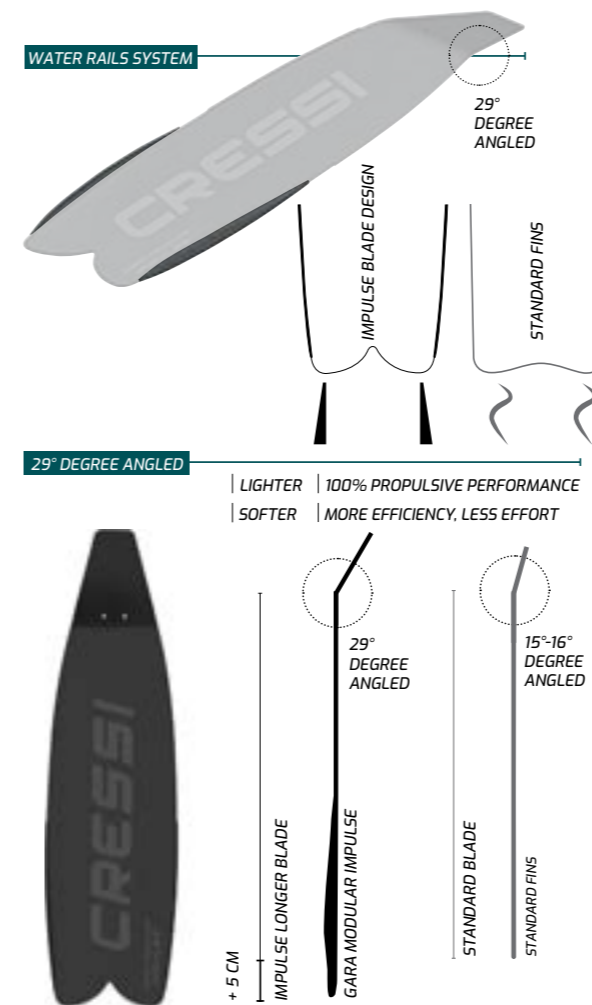

ACCESSORIES

CODE	PRODUCT
BZ175032	RUBBER FIN KEEPER (PAIR) - BLACK (S)
BZ175033	RUBBER FIN KEEPER (PAIR) - BLACK (M)
BZ175034	RUBBER FIN KEEPER (PAIR) - BLACK (L)
BZ180022	INSOLE FOR GARA FINIS

SPARE PARTS

CODE	PRODUCT
BZ180020	GARA MODULAR ASSEMBLY KIT
BH015036	GARA MODULAR TURBO FOOT POCKET [36/37]
BH015038	GARA MODULAR TURBO FOOT POCKET [38/39]
BH015040	GARA MODULAR TURBO FOOT POCKET [40/41]
BH015042	GARA MODULAR TURBO FOOT POCKET [42/43]
BH015044	GARA MODULAR TURBO FOOT POCKET [44/45]
BH015046	GARA MODULAR TURBO FOOT POCKET [46/47]

FITSIZE

FIN SIZE	PRODUCT DIMENSION CHART				SIZE CONVERSION CHART				
	A LENGTH	B WIDTH	C BLADE	FIN HEIGHT FIT	SINGLE FIN WEIGHT	EU FOOT SIZE	UK FOOT SIZE	US MEN'S FOOT SIZE	US WOMEN'S FOOT SIZE
36/37	*671 mm 26.4 in"	*215 mm 8.5 in"	*430 mm 16.9 in"	*83 mm 3.3 in"	*831 g 29.3 oz"	36 / 37	3 / 4	4 / 5	5 / 6
37/38	*683 mm 26.9 in"	*215 mm 8.5 in"	*430 mm 16.9 in"	*84 mm 3.3 in"	*856 g 30.2 oz"	37 / 38	5 / 6	6 / 7	7 / 8
39/40	*700 mm 27.6 in"	*215 mm 8.5 in"	*430 mm 16.9 in"	*87 mm 3.4 in"	*880 g 31.0 oz"	39 / 40	6.5 / 7	7.5 / 8	8.5 / 9
41/42	*712 mm 28.0 in"	*215 mm 8.5 in"	*430 mm 16.9 in"	*92 mm 3.6 in"	*928 g 32.7 oz"	41 / 42	8 / 9	9 / 10	10 / 11
43/44	*725 mm 28.5 in"	*215 mm 8.5 in"	*430 mm 16.9 in"	*97 mm 3.8 in"	*994 g 35.0 oz"	43 / 44	10 / 10.5	11 / 11.5	12 / 12.5
45/46	*734 mm 28.9 in"	*215 mm 8.5 in"	*430 mm 16.9 in"	*103 mm 4.1 in"	*1059 g 37.4 oz"	45 / 46	11 / 12	12 / 13	13 / 14

FINIS COULD COME LABELED WITH EU AND UK SIZES ONLY

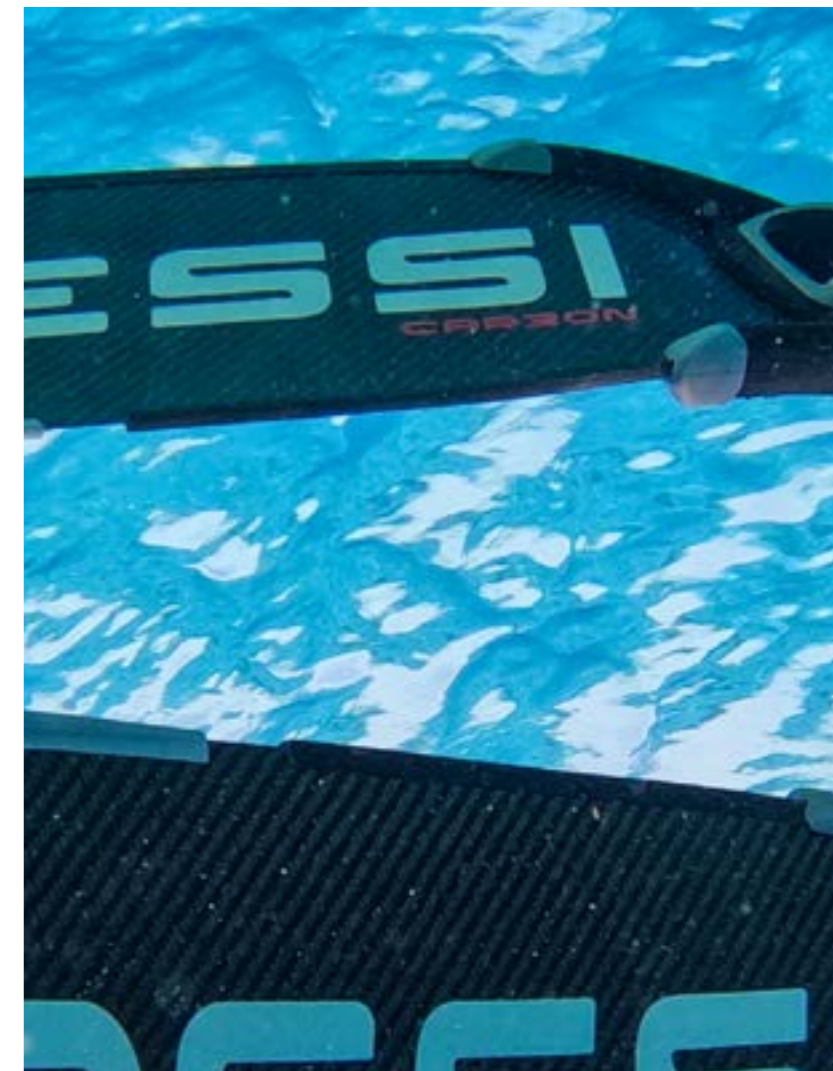

To maximize performance and comfort, wear fins with:

✓	✓		
BARE FOOT	NEOPRENE SOCKS	NEOPRENE BOOTS	HARD SOLE BOOTS

CRESSI'S SIZE CHART IS TO BE USED AS A REFERENCE ONLY



GARA MODULAR IMPULSE

| 29 DEGREE ANGLED INTERCHANGEABLE BLADE

- » LIGHTER
- » SOFTER
- » 100% PROPULSIVE PERFORMANCE
- » MORE EFFICIENCY
- » LESS EFFORT



TECHNICAL FEATURES

- Interchangeable blade
- Superior performance
- Superior comfort
- Self adjusting foot pocket
- Thermoplastic rubber footpocket, certified Full Contact
- Standard blade / stringer interface with screws under the footpocket and side clips



IMPULSE BLADE DESIGN STANDARD FINS

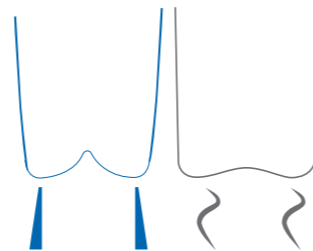

GARA MODULAR INSOLE



- INCLUDED**
- Down-size gara fins foot pockets
 - Preformed insole
 - Easily adjust size



CODE	COLOR	SIZE	CASE PACK
BH092036	Blue	36/37	3
BH092038	Blue	38/39	3
BH092040	Blue	40/41	3
BH092042	Blue	42/43	3
BH092044	Blue	44/45	3
BH092046	Blue	46/47	3
BH093036	White	36/37	3
BH093038	White	38/39	3
BH093040	White	40/41	3
BH093042	White	42/43	3
BH093044	White	44/45	3
BH093046	White	46/47	3
BH095036	Black	36/37	3
BH095038	Black	38/39	3
BH095040	Black	40/41	3
BH095042	Black	42/43	3
BH095044	Black	44/45	3
BH095046	Black	46/47	3

ACCESSORIES

CODE	PRODUCT
BZ175032	RUBBER FIN KEEPER (PAIR) - BLACK (S)
BZ175033	RUBBER FIN KEEPER (PAIR) - BLACK (M)
BZ175034	RUBBER FIN KEEPER (PAIR) - BLACK (L)
BZ180022	INSOLE FOR GARA FINS

SPARE PARTS

CODE	PRODUCT
BZ180020	GARA MODULAR ASSEMBLY KIT
BH015036	GARA MODULAR TURBO FOOT POCKET (36/37)
BH015038	GARA MODULAR TURBO FOOT POCKET (38/39)
BH015040	GARA MODULAR TURBO FOOT POCKET (40/41)
BH015042	GARA MODULAR TURBO FOOT POCKET (42/43)
BH015044	GARA MODULAR TURBO FOOT POCKET (44/45)
BH015046	GARA MODULAR TURBO FOOT POCKET (46/47)



GARA MODULAR

| MINIMUM EFFORT >>> MAXIMUM POWER TRANSFER



TECHNICAL FEATURES

- Interchangeable blade
- Superior performance
- Superior comfort
- Self adjusting foot pocket
- Thermoplastic rubber footpocket, certified Full Contact
- Standard blade / stringer interface with screws under the footpocket and side clips

» Regular stiffness blade



The Gara Modular system makes this a perfect choice for deep freediving and spearfishing for divers of all levels. The modular design lets the user replace/interchange blades for specific diving purposes, which make this the perfect fin to grow with, as the diver can change blades as the divers skills increase. The self adjusting foot pocket is constructed with the

most modern multi compound joining process to deliver a foot pocket that can offer comfort and suppleness around the foot where desired and yet have stiffer compounds under the foot pocket and heel area where power transfer takes place. Can be comfortably worn with or without neoprene socks.

CODE	SIZE	CASE PACK
BH105036	36/37	3
BH105038	38/39	3
BH105040	40/41	3
BH105042	42/43	3
BH105044	44/45	3
BH105046	46/47	3

ACCESSORIES

CODE	PRODUCT
BZ175032	RUBBER FIN KEEPER (PAIR) - BLACK (S)
BZ175033	RUBBER FIN KEEPER (PAIR) - BLACK (M)
BZ175034	RUBBER FIN KEEPER (PAIR) - BLACK (L)
BZ180022	INSOLE FOR GARA FINS

GARA MODULAR INSOLE



INCLUDED

- Down-size gara fins foot pockets
- Preformed insole
- Easily adjust size

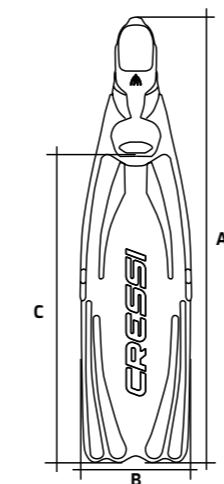

FIT SIZE



To maximize performance and comfort, wear fins with:

✓	✓	✓	✓
BARE FOOT	NEOPRENE SOCKS	NEOPRENE BOOTS	HARD SOLE BOOTS

FIN SIZE	PRODUCT DIMENSION CHART			SINGLE FIN WEIGHT	SIZE CONVERSION CHART		
	A LENGTH	B WIDTH	C BLADE		EU FOOT SIZE	US MEN'S FOOT SIZE	US WOMEN'S FOOT SIZE
38/39	870 mm	215 mm	780 mm	990 g	38/39	7 / 8	8 / 9
40/41	880 mm	215 mm	780 mm	1050 g	40/41	8.5 / 9.5	9.5 / 10.5
42/43	900 mm	215 mm	780 mm	1100 g	42/43	10 / 10.5	11 / 11.5
44/45	915 mm	215 mm	780 mm	1150 g	44/45	11 / 11.5	12 / 12.5
46/47	925 mm	215 mm	780 mm	1240 g	46/47	12 / 13	13 / 14

⚠ FINNS COULD COME LABELED WITH EU AND UK SIZES ONLY

CRESSI'S SIZE CHART IS TO BE USED AS A REFERENCE ONLY

GARA MODULAR SET NEW 2022

| GARA PROFESSIONAL FINS + METIS MASK + CORSICA SNORKEL



Cressi made this set composed of professional items, of high quality and performance, to give the opportunity to use high-standard equipment for freediving and for spearfishing. The Modular system gives the possibility to change the

blades with more performing models. The mirrored lenses of the Metis mask increase the vibrance of the colors underwater and hide the eyes from fishes, not frightening them.

CODE	SIZE	CASE PACK
SE415036	36/37	3
SE415038	38/39	3
SE415040	40/41	3
SE415042	42/43	3
SE415044	44/45	3
SE415046	46/47	3



TECHNICAL FEATURES

- FINS:**
 - Modular interchangeable blade system
 - Superior performance
 - Superior comfort
 - Self-adjusting foot pocket
 - Thermoplastic rubber foot pocket
- MASK:**
 - Mirrored tempered glass lenses
 - Skirt in comfortable soft silicone
 - Wide adjustable buckles
- SNORKEL:**
 - Soft bendable tube
 - Silicone mouthpiece

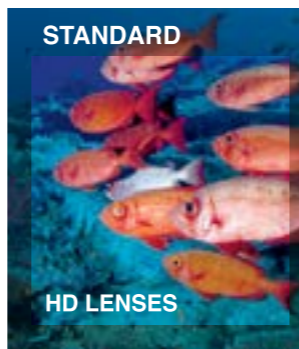

HD MIRRORED LENSES INCREASE THE VISION'S CLEARNESS BY 15%



- INCLUDED**
- Down-size gara fins foot pockets
 - Preformed insole
 - Easily adjust size



GARA MODULAR FOOT POCKET

| SELF ADJUSTING FOOT POCKET

CODE	SIZE	CASE PACK
BH005036	36/37	10
BH005038	38/39	10
BH005040	40/41	10
BH005042	42/43	10
BH005044	44/45	10
BH005046	46/47	10



GARA MODULAR TURBO FOOT POCKET NEW 2022

| SHORTER FOOT POCKET SIDE RAILS

CODE	SIZE	CASE PACK
BH015036	36/37	10
BH015038	38/39	10
BH015040	40/41	10
BH015042	42/43	10
BH015044	44/45	10
BH015046	46/47	10



GARA MODULAR ASSEMBLY KIT

CODE
BZ180020



GARA MODULAR BLADES



CODE	COLOR	STYLE	CASE PACK
BH055000	Black	Modular	3
BH055100	Grey	Modular	3

MODULAR IMPULSE



CODE	COLOR	STYLE	CASE PACK
BH072000	Blue	Modular Impulse	10
BH073000	White	Modular Impulse	10
BH075000	Black	Modular Impulse	10
BH077000	Carbon	Modular Impulse	10



A percentage of the Cressi Gara Modular -Limited Special Edition-blades sales, will be donated for the shark conservation at One Ocean Water Inspired nonprofit organization.



LIMITED SPECIAL EDITION

FINS THAT SAVE FINS

GARA MODULAR BLADE

Designed By Cressi Ambassadors: Ocean Ramsey and Juan Shark

CODE	PRODUCT	DEALER	ASSOCIATE	MASTER	PARTNER	MAP
WBH059902	Gara Modular Blade - Ocean Ramsey Sharks edition	149.95	149.95	149.95	149.95	199.95

OCEAN RAMSEY SHARKS EDITION



BLADES MATERIAL MEDIUM COMPOSITE FIBERGLASS

The Composite Fibreglass is the world's most advanced composite diving fin blades. The customized hybrid epoxy resin system, coupled with state of the art design and aerospace grade fabric combine to create a fin that transfers the load to the larger muscle groups, instead of focusing on any one specific location. All the blades are hand made by DiveR in Australia and come with a 3-year warranty.



FRONT

BACK

HOW-TO VIDEOS



GARA 3000 LD

| LONG DISTANCE



TECHNICAL FEATURES

- Durable construction designed to take abuse
- Soft long blade for ease of use
- Full footpocket for comfort
- Long blade for efficiency



The Gara 3000 LD is Cressi's entry-level long blade fin designed with softer blades, which makes the Gara 3000 a perfect choice for the beginning diver or those unexperienced with long-fin blades. The Gara 3000 is constructed with durability in mind and long soft plastic blades that can effectively transfer power with minimum effort.

This makes the fin comfortable and easy on the legs for beginners as well as during long duration dives.

The Gara 3000 is an extremely comfortable and is a full footpocket style fin. This fin is also constructed using Cressi's unique three material molding process, where different compounds are bonded together to provide flexibility in the foot area, while being able to deliver power through the blade due to the stiffness the process provides. Can comfortably be worn with or without neoprene socks.

CODE	SIZE	CASE PACK
BH135140	40/41	3
BH135142	42/43	3
BH135144	44/45	3
BH135146	46/47	3

ACCESSORIES

CODE	PRODUCT
BZ175032	RUBBER FIN KEEPER (PAIR) - BLACK (S)
BZ175033	RUBBER FIN KEEPER (PAIR) - BLACK (M)
BZ175034	RUBBER FIN KEEPER (PAIR) - BLACK (L)
BZ180022	INSOLE FOR GARA FINS

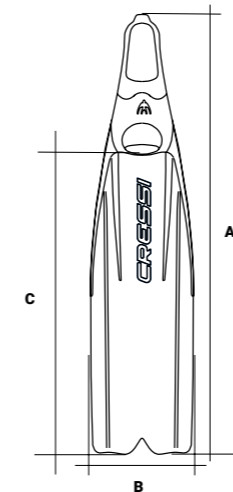

FIT SIZE



To maximize performance and comfort, wear fins with:

<input checked="" type="checkbox"/>	<input checked="" type="checkbox"/>	<input type="checkbox"/>	<input type="checkbox"/>
BARE FOOT	NEOPRENE SOCKS	NEOPRENE BOOTS	HARD SOLE BOOTS

FIN SIZE	PRODUCT DIMENSION CHART				SIZE CONVERSION CHART			
	A LENGTH	B WIDTH	C BLADE	SINGLE FIN WEIGHT	EU FOOT SIZE	UK FOOT SIZE	US MEN'S FOOT SIZE	US WOMEN'S FOOT SIZE
40/41	870 mm 24.3 in	210 mm 8.3 in	690 mm 27.2 in	861 g 1.89 lb	40/41	7 / 8	7.5 / 8.5	8.5 / 9.5
42/43	885 mm 34.9 in	210 mm 8.3 in	705 mm 27.8 in	952 g 2.09 lb	42/43	8 / 9	8.5 / 9.5	9.5 / 10.5
44/45	905 mm 35.7 in	215 mm 8.5 in	715 mm 28.2 in	984 g 2.16 lb	44/45	10 / 11	10.5 / 11.5	11.5 / 12.5
46/47	925 mm 36.5 in	220 mm 8.7 in	725 mm 28.6 in	1066 g 2.35 lb	46/47	12 / 13	12.5 / 13.5	13.5 / 14.5

CRESSI'S SIZE CHART IS TO BE USED AS A REFERENCE ONLY

GARA 2000 HF

| HIGH FREQUENCY



Gara 2000 HF is an icon in the diving industry, and is the first fin in the industry to be manufactured using a three material molding process. Due to its lightweight and durability, it is an excellent choice for those looking for a fin that can provide the ultimate in performance while deep freediving and spearfishing, and those looking for obtaining maximum depths. The GARA 2000 has the stiffest blade in the CRESSI line and is

an extremely comfortable full footpocket style fin, with long firm blades with built in stringers and runners to effectively direct water flow down the blade aiding in efficiency. This fin is constructed using multiple compounds bonded together to provide comfort and suppleness in the foot area and strength and rigidity in the heel and blade area. Can comfortably be worn with or without neoprene socks.

CODE	SIZE	CASE PACK
BH115040	40/41	3
BH115042	42/43	3
BH115044	44/45	3
BH115046	46/47	3

ACCESSORIES

CODE	PRODUCT
BZ175032	RUBBER FIN KEEPER (PAIR) - BLACK (S)
BZ175033	RUBBER FIN KEEPER (PAIR) - BLACK (M)
BZ175034	RUBBER FIN KEEPER (PAIR) - BLACK (L)
BZ180022	INSOLE FOR GARA FINS

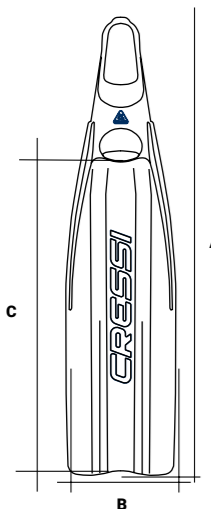

FIT SIZE



To maximize performance and comfort, wear fins with:

<input checked="" type="checkbox"/>	<input checked="" type="checkbox"/>	<input type="checkbox"/>	<input type="checkbox"/>
BARE FOOT	NEOPRENE SOCKS	NEOPRENE BOOTS	HARD SOLE BOOTS

FIN SIZE	PRODUCT DIMENSION CHART				SIZE CONVERSION CHART			
	A LENGTH	B WIDTH	C BLADE	SINGLE FIN WEIGHT	EU FOOT SIZE	UK FOOT SIZE	US MEN'S FOOT SIZE	US WOMEN'S FOOT SIZE
40/41	845 mm 33.3 in	215 mm 8.5 in	660 mm 26 in	790 g 1.74 lb	40/41	7 / 8	6.5 / 8	7.5 / 9
42/43	860 mm 33.9 in	215 mm 8.5 in	660 mm 26 in	895 g 1.97 lb	42/43	8 / 9	8 / 9.5	9 / 10.5
44/45	875 mm 34.4 in	220 mm 8.7 in	26.6 in 675 mm	970 g 2.13 lb	44/45	10 / 11	9.5 / 10.5	10.5 / 11.5
46/47	890 mm 35 in	223 mm 8.8 in	26.6 in 675 mm	1030 g 2.27 lb	46/47	12 / 13	11.5 / 12.5	12 / 13.5

CRESSI'S SIZE CHART IS TO BE USED AS A REFERENCE ONLY



GARA PROFESSIONAL LD

| LONG DISTANCE



BLUE BLACK

The Gara Professional LD is a high performance fin, requiring minimum effort to load the long blades. They are more forgiving than other long blade fins for untrained legs, making this an excellent choice for deep freedivers and spearfishers of all levels. They are ideal for long distance swimming, while ultimately providing the power and efficiency needed for deep freediving and spearfishing. Due to the multi compound bonding process

used during the manufacturing process, the Gara Pro LD is an exceptionally soft full footpocket style fin, which provides comfort during prolonged use on those long days in the water. Gara Pro LD delivers maximum power with minimum energy through its long firm blade that runs over the footpocket. Can comfortably be worn with or without neoprene socks.

TECHNICAL FEATURES

- Firm Blade designed to run over the footpocket for ease of use
- Full footpocket for comfort
- Thermo-Rubber soles for extra grip on wet surfaces
- Stiff Long Blade designed for maximum depths
- Full footpocket for comfort
- Long blade for efficiency

CODE	COLOR	SIZE	CASE PACK
BH142040	Blue	40/41	3
BH142042	Blue	42/43	3
BH142044	Blue	44/45	3
BH142046	Blue	46/47	3
BH145140	Black	40/41	3
BH145142	Black	42/43	3
BH145144	Black	44/45	3
BH145146	Black	46/47	3

ACCESSORIES

CODE	PRODUCT
BZ175032	RUBBER FIN KEEPER (PAIR) - BLACK (S)
BZ175033	RUBBER FIN KEEPER (PAIR) - BLACK (M)
BZ175034	RUBBER FIN KEEPER (PAIR) - BLACK (L)
BZ180022	INSOLE FOR GARA FINS

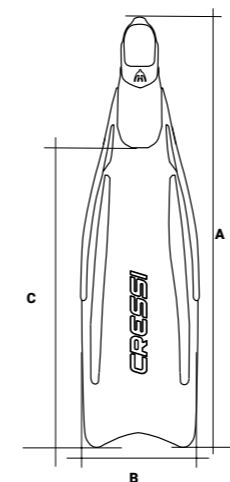

FIT SIZE



To maximize performance and comfort, wear fins with:

<input checked="" type="checkbox"/>	<input checked="" type="checkbox"/>	<input type="checkbox"/>	<input type="checkbox"/>
BARE FOOT	NEOPRENE SOCKS	NEOPRENE BOOTS	HARD SOLE BOOTS

FIN SIZE	PRODUCT DIMENSION CHART				SIZE CONVERSION CHART			
	A LENGTH	B WIDTH	C BLADE	SINGLE FIN WEIGHT	EU FOOT SIZE	UK FOOT SIZE	US MEN'S FOOT SIZE	US WOMEN'S FOOT SIZE
40/41	870 mm 34.3 in	220 mm 8.7 in	260 mm 10.3 in	861 g 1.89 lb	40/41	7 / 8	8 / 9	9 / 10
42/43	890 mm 35.1 in	225 mm 8.9 in	278 mm 11 in	952 g 2.09 lb	42/43	8 / 9	9 / 10	10 / 11
44/45	900 mm 35.5 in	233 mm 9.2 in	290 mm 11.4 in	984 g 2.16 lb	44/45	10 / 11	10.5 / 11.5	11.5 / 12.5
46/47	915 mm 36.1 in	242 mm 9.5 in	302 mm 11.9 in	1066 g 2.35 lb	46/47	12 / 13	12 / 13	13 / 14

CRESSI'S SIZE CHART IS TO BE USED AS A REFERENCE ONLY

GARA MODULAR SPRINT

| 29° DEGREE ANGLED INTERCHANGEABLE BLADE



BLUE METAL

BLACK

TECHNICAL FEATURES

- Excellent propulsive performance without fatigue, ideal for beginners or professionals
- Thermoplastic rubber foot pocket, certified Full Contact
- Standard blade/stringer interface with screws under the foot pocket and side clips
- Extremely thin and light blade in compound made of elastomerized technopolymers developed by Cressi with different thicknesses
- Stringer consisting of technopolymers with elastomeric loads with high flexural modulus
- Foot pocket/blade angle of 29 degrees

- » All fin components are also supplied separately
- » INTERCHANGEABLE BLADE
- » SUPERIOR PERFORMANCE
- » SUPERIOR COMFORT
- » SELF ADJUSTING FOOT POCKET

The new Gara Modular Sprint fin is a shorter version of the Impulse fin, which proved to be hugely popular with freedivers worldwide, both amateurs and the most demanding professional freedivers. This is also confirmed by the large number of articles dedicated to it by specialized journalists in sector magazines.

Sprint is designed to meet the needs of freedivers and spearfishers who practice this sport in wintertime and when a fin as long as Impulse is not necessary. Both fins have been designed using expensive finite element software programs that allow highly complex and equally high performance sections to be defined. The blade of Sprint, like the Impulse blade, is made of a single thermoplastic elastomer, although it would be more correct

to refer to an angled sublayer and an overlay. The sublayer follows the shape and dimensions of almost the entire fin. It has a uniform thickness and a flexible longitudinal propulsion wing of variable length. In contrast, the so-called overlay covers the propulsion wing selectively and has a thickness that slopes from the maximum value to zero longitudinally towards the tip of the blade. As a result, the fin offers a new way of storing and releasing elastic potential energy, greatly assisting movement of the freediver's legs and thus guaranteeing a net improvement in propulsive output. When disassembled, the blade and foot pocket occupy the space of a normal snorkeling fin.

CODE	COLOR	SIZE	CASE PACK
BH082036	Blue	36/37	3
BH082038	Blue	38/39	3
BH082040	Blue	40/41	3
BH082042	Blue	42/43	3
BH082044	Blue	44/45	3
BH082046	Blue	46/47	3
BH085036	Black	36/37	3
BH085038	Black	38/39	3
BH085040	Black	40/41	3
BH085042	Black	42/43	3
BH085044	Black	44/45	3
BH085046	Black	46/47	3

ACCESSORIES

CODE	PRODUCT
BZ175032	RUBBER FIN KEEPER (PAIR) - BLACK (S)
BZ175033	RUBBER FIN KEEPER (PAIR) - BLACK (M)
BZ175034	RUBBER FIN KEEPER (PAIR) - BLACK (L)
BZ180022	INSOLE FOR GARA FINS

SPARE PARTS

CODE	PRODUCT
BZ180020	GARA MODULAR ASSEMBLY KIT
BH005036	GARA MODULAR FOOT POCKET (PAIR) (36/37)
BH005038	GARA MODULAR FOOT POCKET (PAIR) (38/39)
BH005040	GARA MODULAR FOOT POCKET (PAIR) (40/41)
BH005042	GARA MODULAR FOOT POCKET (PAIR) (42/43)
BH005044	GARA MODULAR FOOT POCKET (PAIR) (44/45)
BH005046	GARA MODULAR FOOT POCKET (PAIR) (46/47)

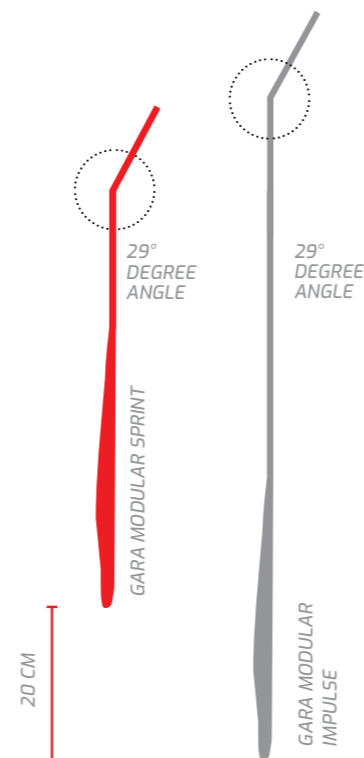

GARA PROFESSIONAL SET 3.0

2022 RESTYLE

| GARA PROFESSIONAL LD FINS + METIS MASK + CORSICA SNORKEL



METIS MASK

CORSICA SNORKEL

GARA PROFESSIONAL LD FINS

LONG FINS SET BAG

Cressi made this set composed by professional items, of high quality and performance, to give the opportunity to use a high standard equipment for freediving and for spearfishing.

CODE	SIZE	CASE PACK
SE401040	40/41	2
SE401042	42/43	2
SE401044	44/45	2
SE401046	46/47	2

RUBBER FIN KEEPER



The simple things in life often turn out to be the most useful and Fin Keepers are a perfect example. Their benefit is great especially if your foot pocket fits a little loose. They are a simple, inexpensive concept that works great, they last for years, yet rarely mentioned. Fin keepers keep the foot pocket tight against the heel giving the diver full fin power. You can't truly appreciate

them until you use them. When you do, you will notice the difference in power instantly. By holding the foot pocket against the bottom of the heel they limit or delete lost power. Without fin keepers every time you kick the fin the foot pocket will lift off your heel. Just a 1/4" of movement away from the heel will result in major power loss. Power is lost but spent energy is unchanged.



CODE	SIZE	CASE PACK
BZ175032	S	10
BZ175033	M	10
BZ175034	L	10



FREEDIVING MASK

85%
MANUFACTURE
QUALITY SINCE
1946

CRESSI
vicciola

CALIBRO SF

| PATENTED INNOVATIVE FOG STOP SYSTEM



BLACK

GREEN

BLACK HD EDITION

Cressi's next generation diving masks are all equipped with the Integrated Dual Frame Technology which offers exceptional field of view, and the new Calibro is no exception. The mask is designed so that the integrated face and frame allow for an extremely hydrodynamic and compact shape and a particularly wide lens, maintaining the mask extremely close to the face. Cressi's Calibro combines minimal internal volume with a phenomenal field of view due to the raked angle of the frame.

The buckles are, as always, directly integrated into the rigid skirt through a solid but flexible rubber attachment that allows you to adjust and place the mouthpiece without shifting the mask. Thanks to its matte coating the mask's components all match, enhancing the underwater experience since it prevents reflections in the water that may disturb marine life. Calibro is the perfect mask for freediving since it is designed to provide the diver with a feeling of total freedom and comfort.

CODE	COLOR	CASE PACK
DS425050	Black	6
DS429850	Green	6
DS426050	Black HD Edition	6

TECHNICAL FEATURES

- Ultra low volume
- Tempered glass
- Micrometric adjustable buckle
- Flexible buckle

STANDARD



HD LENSES

HD MIRRORED LENSES INCREASE THE VISION'S CLEARNESS BY 15%

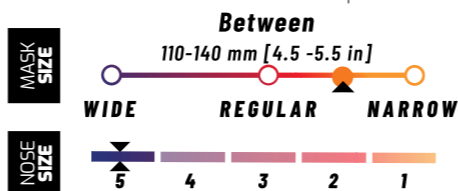
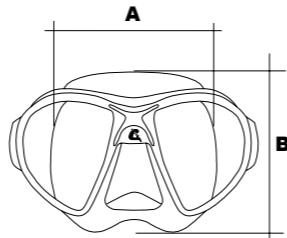

PRODUCT DIMENSION CHART (SKIRT SIZE)

A WIDTH (mm)	B HEIGHT (mm)	A WIDTH (in)	B HEIGHT (in)
112	103	4 7/16	4 1/16

CRESSI'S SIZE CHART IS TO BE USED AS A REFERENCE ONLY



CRESSI PATENTED TECHNOLOGIES

★ INCLINED GLASSES US 6272693 B1

Cressi has developed and patented in 2001 a particular mask frame that to solve the problem of the divers not being able to easily see the scuba equipment. A scuba diver carrying many different pieces of equipment, some of them are vital like the pressure and depth gauges. The solution has been found designing a new frame shape that is inclined downwards. Moreover, the shape of the lens is designed like an inverted teardrop increasing drastically the downward visibility.

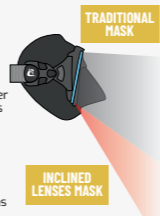

★ INTEGRATED BUCKLES US 8281417 B2

The patented technology is to provide a mask for aquatic activities that avoid loss of watertight during strap-tightening by a diver when the mask is in use underwater. The object of the invention is to avoid exertion of a tensile force or stress during mask adjustment and, in turn, rupture of the skirt. The buckles are not directly fixed to the frame but anchored to the rubber of the skirt, allowing it to freely swivel and pivot in all directions. The buckles are joined with lateral sides of the frame by brackets extending from the lateral sides. The brackets are made of a selected flexible material. This feature facilitates the mask storage when not in use.

★ INTEGRATED DUAL FRAME US 20140013494 A1

The Patented Integrated Dual Frame Technology consists of the joining of two rigid frames, the first on the rear of the silicone skirt and the second, anterior to the first one, that support the lenses. When the two frames are joined and locked together, the silicone skirt remains locked in the middle to guarantee a perfect seal between the face piece and the lens. This technology produces a drastic reduction in the internal volume, while keeping the lenses close to the eyes to ensure a wide view laterally and in the lower zone. The result is a mask with an extremely hydrodynamic shape and low volume.

★ ANTI-FOG SYSTEM PATENT PENDING

A patented membrane surrounding the inner nose pocket which acts as a barrier and traps any moisture escaping from the diver's nose involuntarily when breathing through the mouth. Not only is the moisture channeled away from the lenses, thus avoiding the fogging up of them, but it also reduces the need to compensate for pressure.

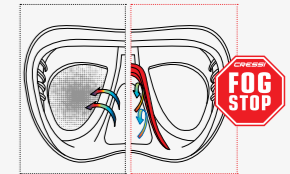

NANO

| 85 CM³: ULTRA LOW VOLUME



BLACK

BLACK HD EDITION

GREEN EDITION

The Nano is for advanced divers, freediving and spearfishing lovers, designed to offer an extremely hydrodynamic and compact shape to help divers cut through the water and aid movements in small spaces. To develop the Nano mask, Cressi invented and patented the Integrated Dual Frame Technology System that joins the silicone skirt to the rigid frame lens without interruptions to

guarantee a perfect seal and drastically reduce the internal volume. It does not require intentional equalizing. The swiveling buckles feature micrometric regulation. The mask features inverted teardrop lenses slightly inclined made in tempered glass. An anatomical strap ensures a perfect seal on the head. Available with mirrored lenses to hide your eyes while attracting fish.

CODE	COLOR	CASE PACK
DS365050	Black/Black	6
DS366050	Black/Black, HD Edition	6
DS369850	Green/Green	6

SPARE PARTS

CODE	PRODUCT
DZ215002	SILICONE STRAP - SILVER for CRYSTAL MASKS
DZ215003	SILICONE STRAP - CLEAR for ITALIAN SCUBA MASK
DZ215004	SILICONE STRAP - BLACK for ITALIAN SCUBA MASK
DZ210021	BUCKLES - BLACK for AIR/BIG EYES EVO/EYES EVO/NANO/OCCHIO P.
DZ215009	STRAP LOOP SMALL for PRO DIVE MASKS - CLEAR (PAIR)
DZ215011	STRAP LOOP SMALL for PRO DIVE MASKS - BLACK (PAIR)

CRESSI PATENTED TECHNOLOGIES

INCLINED GLASSES
US 6272693 B1

INTEGRATED BUCKLES
US 8281417 B2

INTEGRATED DUAL FRAME
US 20140013494 A1

PACKAGING



TECHNICAL FEATURES

- Double injection technology
- Flexible buckle

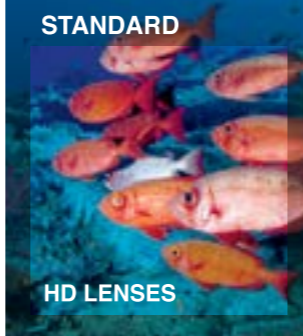

HD MIRRORED LENSES INCREASE THE VISION'S CLEARNESS BY 15%

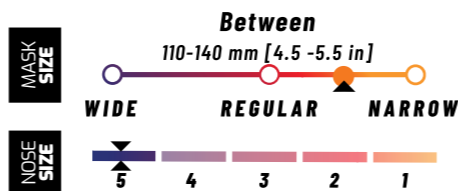
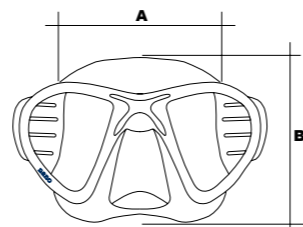

PRODUCT DIMENSION CHART (SKIRT SIZE)

A WIDTH (mm)	B HEIGHT (mm)	A WIDTH (in)	B HEIGHT (in)
118	104	4 9/16	4 2/16

CRESSI'S SIZE CHART IS TO BE USED AS A REFERENCE ONLY

AIR



BLACK/YELLOW

BLACK/BLACK

BLACK/BLUE

BLUE METAL

The Air mask has a particular tapered structure deriving directly from the highly popular Nano-mask patent. The Dual Integrated Frame Technology System joins the silicone skirt to the lens frame without major interruptions of the curvature continuity. The result is a mask with an extremely hydrodynamic shape and a significantly smaller size, with equal

visibility. Thanks to the Inclined Lens Patented Technology, the field of view obtained is particularly wide, laterally and in the lower zone. The skirt, in the front part, has a structural silicone insert which increases the sealing ability of the mask and creates an exceptionally pleasant chromatic play. Micrometer adjustable buckles.

CODE	COLOR	CASE PACK
DS405010	Black/Yellow	6
DS405050	Black/Black	6
DS405062	Black/Blue	6
DS405550	Blue Metal	6

SPARE PARTS

CODE	PRODUCT
DZ215003	SILICONE STRAP - CLEAR for ITALIAN SCUBA MASK
DZ215004	SILICONE STRAP - BLACK for ITALIAN SCUBA MASK
DZ210021	BUCKLES - BLACK for AIR/BIG EYES EVO/EYES EVO/NANO/OCCHIO P.
DZ215009	STRAP LOOP SMALL for PRO DIVE MASKS - CLEAR (PAIR)
DZ215011	STRAP LOOP SMALL for PRO DIVE MASKS - BLACK (PAIR)

CRESSI PATENTED TECHNOLOGIES

INCLINED GLASSES
US 6272693 B1

INTEGRATED BUCKLES
US 8281417 B2

INTEGRATED DUAL FRAME
US 20140013494 A1

PACKAGING



TECHNICAL FEATURES

- Double injection technology
- Flexible buckle



HD MIRRORED LENSES INCREASE THE VISION'S CLEARNESS BY 15%

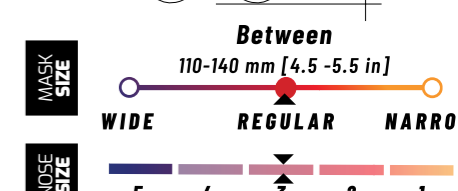
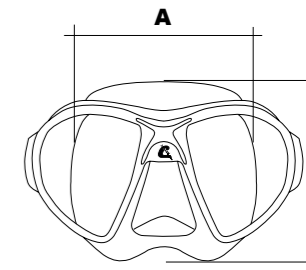

PRODUCT DIMENSION CHART (SKIRT SIZE)

A WIDTH (mm)	B HEIGHT (mm)	A WIDTH (in)	B HEIGHT (in)
115	110	4 9/16	4 5/16

CRESSI'S SIZE CHART IS TO BE USED AS A REFERENCE ONLY

BIG EYES EVOLUTION



BLACK
BLACK HD EDITION

The Big Eyes Evolution's signature inverted tear-drop lenses are raked inward and provide outstanding field of view with very low internal volume. A redesigned skirt now uses internal ribs to provide the ultimate in fit and

support. Fully flexible, easy to adjust buckles are attached using Cressi's double injection molding technology for both comfort and extreme durability.

CODE	COLOR	CASE PACK
D5336550	Black	6
D5336950	Black HD Edition	6

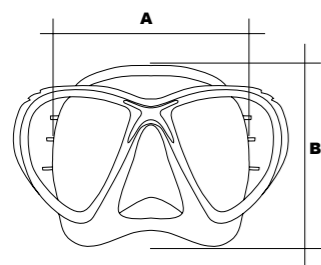

PRODUCT DIMENSION CHART (SKIRT SIZE)

A WIDTH (mm)	B HEIGHT (mm)	A WIDTH (in)	B HEIGHT (in)
124	110	4 14/16	4 5/16

CRESSI'S SIZE CHART IS TO BE USED AS A REFERENCE ONLY

CRESSI PATENTED TECHNOLOGIES

★ INCLINED GLASSES
US 6272693 B1

★ INTEGRATED BUCKLES
US 8281417 B2

★ INTEGRATED DUAL FRAME
US 20140013494 A1



TECHNICAL FEATURES

- Double injection technology
- Raked lenses provide excellent field-of-view low internal volume allows for effortless clearing
- Dual-density silicone skirt flexes for a perfect seal along the face and full support around the frame

STANDARD



HD MIRRORED LENSES INCREASE THE VISION'S CLEARNESS BY 15%

OPTICAL LENSES

Possibility of mounting optical lenses CORRECTION -1.0 > -6.00

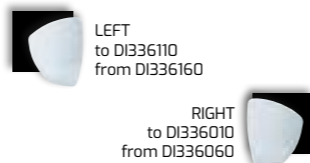

OPTICAL LENSES INSTALLATION \$ 5.00

SYMMETRICAL LENSES

The lenses are positive for correcting negative dioptres (myopia)

COMPLETE INFORMATION

OPTICAL LENSES
Please refer to page 337 chart

CODE	PRODUCT
DI260010	Optical Lens -1.0 (Right)
DI260015	Optical Lens -1.5 (Right)
DI260020	Optical Lens -2.0 (Right)
DI260025	Optical Lens -2.5 (Right)
DI260030	Optical Lens -3.0 (Right)
DI260035	Optical Lens -3.5 (Right)
DI260040	Optical Lens -4.0 (Right)
DI260045	Optical Lens -4.5 (Right)
DI260050	Optical Lens -5.0 (Right)
DI260055	Optical Lens -5.5 (Right)
DI260060	Optical Lens -6.0 (Right)
DI260110	Optical Lens -1.0 (Left)
DI260115	Optical Lens -1.5 (Left)
DI260120	Optical Lens -2.0 (Left)
DI260125	Optical Lens -2.5 (Left)
DI260130	Optical Lens -3.0 (Left)
DI260135	Optical Lens -3.5 (Left)
DI260140	Optical Lens -4.0 (Left)
DI260145	Optical Lens -4.5 (Left)
DI260150	Optical Lens -5.0 (Left)
DI260155	Optical Lens -5.5 (Left)
DI260160	Optical Lens -6.0 (Left)

EYES EVOLUTION



TECHNICAL FEATURES

- Flexible buckle
- Designed for those with a narrow or small face

STANDARD



HD MIRRORED LENSES INCREASE THE VISION'S CLEARNESS BY 15%

The Eyes Evolution Crystal comes with all of the great features of the Big Eyes Evolution Crystal, but in a smaller size that makes it ideal for women and smaller faces. The Crystal Silicone is an exclusive

Cressi material that's so clear the mask's skirt is virtually invisible when diving.

The thickness of the mask frame has been reduced to such an extent that it is practically invisible when the mask is being worn.

CODE	COLOR	CASE PACK
D5355050	Black	6

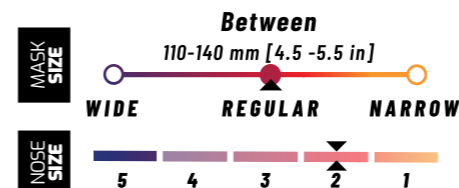
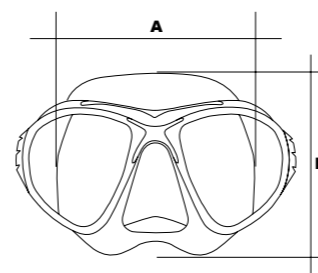

PRODUCT DIMENSION CHART (SKIRT SIZE)

A WIDTH (mm)	B HEIGHT (mm)	A WIDTH (in)	B HEIGHT (in)
114	106	4 8/16	4 3/16

CRESSI'S SIZE CHART IS TO BE USED AS A REFERENCE ONLY

CRESSI PATENTED TECHNOLOGIES

★ INCLINED GLASSES
US 6272693 B1

★ INTEGRATED BUCKLES
US 8281417 B2

★ INTEGRATED DUAL FRAME
US 20140013494 A1



PACKAGING

Z1

| LOW VOLUME FRAMELESS MASK



Z1 is a frameless mask that boasts a low internal volume while offering a wide field of view in all directions.

The specific design uses the assembly of the silicone skirt directly over the single glass. This system guarantees great sturdiness and

a perfect watertight seal. The lower weight of the mask makes it ideal for travel. The flexible fit and reduced drag are appreciated for freediving and spearfishing, snorkeling and diving. The micrometrically adjustable buckles are comfortable and effective.

CODE	COLOR	CASE PACK
DN410000	Clear/Clear	30
DN410020	Blue/Blue	30
DN410050	Black/Black	30
DN410057	Graphite/Graphite	30
DN410080	Red/Red	30

ZS1 NEW 2022

| SMALLER VERSION OF Z1 MASK



ZS1 is the Small version, suitable for adults with small faces, of the Z1, a frameless mask that boasts a low internal volume while offering a wide field of view in all directions. The specific design uses the assembly of the silicone skirt directly over the single glass. This system guarantees great sturdiness and

a perfect watertight seal. The lower weight of the mask makes it ideal for travel. The flexible fit and reduced drag are appreciated for freediving and spearfishing, snorkeling and diving. The micrometrically adjustable buckles are comfortable and effective.

CODE	COLOR	CASE PACK
DN420000	Clear/clear	30
DN422828	Turquoise/turquoise	30
DN423030	White/white	30
DN424545	Pink fluo/pink fluo	30
DN425050	Black/black	30



TECHNICAL FEATURES

- Low-volume, single lens design for a wide field-of-view
- **Frameless:** silicone skirt bonds directly to the lens for lower weight and reduced drag
- Fast-adjust ratcheting strap buckles mounted to skirt
- High-grade silicone seals
- Tempered glass lens
- Easy-access nose pocket for equalization

- » Micrometric adjustable buckle
- » Tempered glass

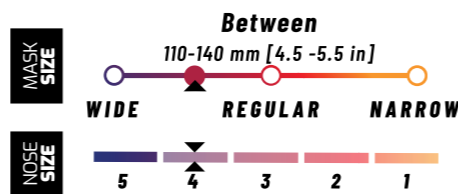

PRODUCT DIMENSION CHART (SKIRT SIZE)

A WIDTH (mm)	B HEIGHT (mm)	A WIDTH (in)	B HEIGHT (in)
122	101	4 13/16	4

CRESSI'S SIZE CHART IS TO BE USED AS A REFERENCE ONLY
 ++MEASURE EAR TO EAR WITH A RULER

TECHNICAL FEATURES

- Low-volume, single lens design for a wide field-of-view
- **Frameless:** silicone skirt bonds directly to the lens for lower weight and reduced drag
- Fast-adjust ratcheting strap buckles mounted to skirt
- High-grade silicone seals

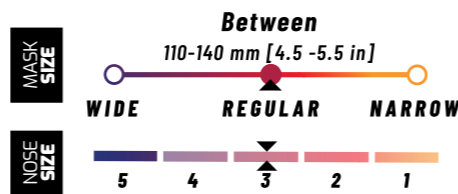

PRODUCT DIMENSION CHART (SKIRT SIZE)

A WIDTH (mm)	B HEIGHT (mm)	A WIDTH (in)	B HEIGHT (in)
119	96	4 11/16	3 12/16

CRESSI'S SIZE CHART IS TO BE USED AS A REFERENCE ONLY
 ++MEASURE EAR TO EAR WITH A RULER



MATRIX



The compact twin-lens Matrix takes the basic design concepts of the Big Eyes Evolution and pushes them to a new level of performance.

More pronounced inverted tear-drop shaped lenses, raked inward to sit even closer to the eyes, and a more compact build overall make the Matrix an ideal choice for divers and freedivers looking for the biggest view in the smallest package.

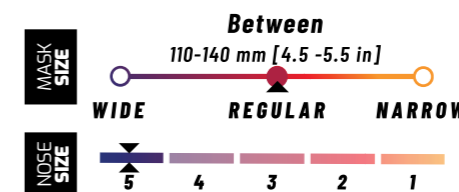
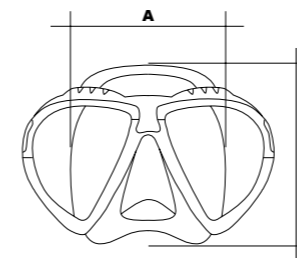

CODE	COLOR	CASE PACK
DS302050	Black	6
DS309850	Green	6

LINCE

A trimmed down version of the Matrix, the Lince is a perfect fit for many younger divers or those with narrower faces. The extremely low internal volume makes it comfortable to wear and effortless to clear. Divers and snorkelers alike will appreciate the exceptional field of view offered in this ultra compact mask.

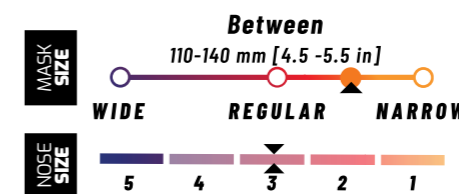
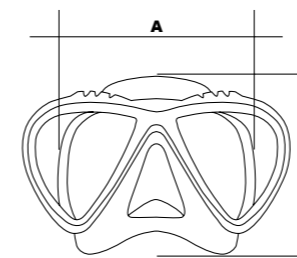

CODE	COLOR	CASE PACK
DS312050	Black	6

TECHNICAL FEATURES

- Raked lenses provide excellent field-of-view
- Extremely low internal volume on par with the best freediving masks
- Silicone skirt shaped to provide a wide sealing surface for a leak-free fit
- Micrometric adjustable buckles allow precise headband adjustments
- Inverted tear-drop lenses improve downward vision for viewing your BCD while diving



PRODUCT DIMENSION CHART (SKIRT SIZE)

A WIDTH (mm)	B HEIGHT (mm)	A WIDTH (in)	B HEIGHT (in)
122	111	4 13/16	4 6/16

CRESSI'S SIZE CHART IS TO BE USED AS A REFERENCE ONLY

TECHNICAL FEATURES

- Raked lenses provide excellent field-of-view
- Extremely low internal volume on par with the best free diving masks
- Silicone skirt shaped to provide a wide sealing surface for a leak-free fit
- Micrometric adjustable buckles allow precise headband adjustments
- Inverted tear-drop lenses improve downward vision for viewing your BC while diving



PRODUCT DIMENSION CHART (SKIRT SIZE)

A WIDTH (mm)	B HEIGHT (mm)	A WIDTH (in)	B HEIGHT (in)
129	107	5 1/16	4 3/16

CRESSI'S SIZE CHART IS TO BE USED AS A REFERENCE ONLY

METIS



Ideal
with snorkel
CORSICA
Hunter line



The Metis is a two-window mask suitable for scuba diving and also for snorkeling. The skirt is completely made in high quality silicone, a more comfortable and long lasting material than the traditional plastic PVC. The silicone skirt allows to be fitted from different kinds of face shapes and ensure a perfect seal. Also the strap is made in silicone and it is large and wide behind the neck to ensure a tight fit and comfort. The length of the strap is easy to adjust thanks to the simple push of the wide buckles. You can choose different kind of lenses, colored or mirrored,

to increase the view underwater. All the lenses are made in tempered glass to ensure shatterproof and scratch resistance. The nose pocket is soft and easy to access used with only two fingers for proper equalization, also wearing gloves.

Special lenses edition are ideal per spearfishing and photographers. Yellow lenses increase the vibrancy of the colors and helps to see better the details in depth water. Available with Mirrored Lenses for hiding your eyes to the fishes.

CODE	COLOR	CASE PACK
US411010	BLACK/BLACK (YELLOW LENS)	10
US411050	BLACK/BLACK (MIRROR LENS)	10
US411223	BLUE HUNTER	10
US411253	BROWN HUNTER	10
US411293	GREEN HUNTER	10
US411500	BLACK/BLACK	10
US411570	BROWN/BROWN	10
US415550	BLACK/BLACK - CLEAR ANTI-FOG LENS	10

CODE	PRODUCT
DZ222050	STRAP for SCUBA MASK TW - BLACK
DZ221050	BUCKLES for SCUBA MASK TW - BLACK/BLACK
DZ215012	STRAP LOOP for SCUBA MASK TW - BLACK (PAIR)



TECHNICAL FEATURES

- Low internal volume
- Inverted teardrop lenses shape
- Very light



HD MIRRORED LENSES INCREASE THE VISION'S CLEARNESS BY 15%

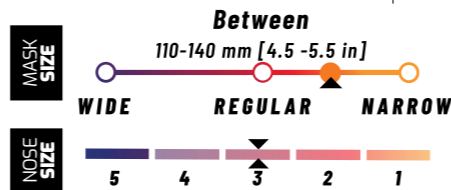
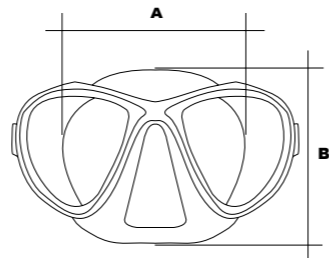

PRODUCT DIMENSION CHART (SKIRT SIZE)			
A WIDTH (mm)	B HEIGHT (mm)	A WIDTH (in)	B HEIGHT (in)
120	105	4 12/16	4 2/16

CRESSI'S SIZE CHART IS TO BE USED AS A REFERENCE ONLY



FOCUS



TECHNICAL FEATURES

- Low internal volume allows for effortless clearing
- Lightweight, compact and rugged
- Ideal for travel or as a backup mask
- High-grade silicone skirt provides a leak-free seal
- Quick-adjust swivel buckles prevent binding



HD MIRRORED LENSES INCREASE THE VISION'S CLEARNESS BY 15%

The ultimate in versatility, this classic mask offers the best fit and performance for the greatest variety of facial shapes. Its low-volume, twin-lens design gives divers

and snorkelers a proven combination of size, fit and durability. Lightweight and easy-to-clear, it has swiveling, quick-adjust buckles and accepts corrective lenses. It is also an excellent value.

CODE	COLOR	CASE PACK
DS242050	Black/Black	6
DS242550	Black HD Edition	6

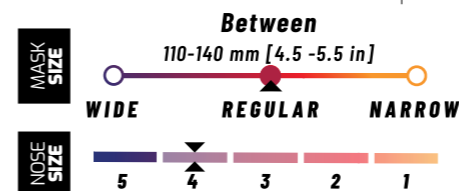
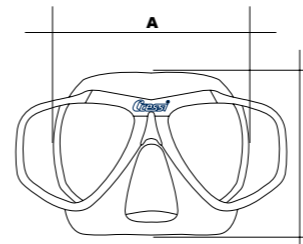

PRODUCT DIMENSION CHART (SKIRT SIZE)

A WIDTH (mm)	B HEIGHT (mm)	A WIDTH (in)	B HEIGHT (in)
122	105	4 13/16	4 8/16

CRESSI'S SIZE CHART IS TO BE USED AS A REFERENCE ONLY

OPTICAL LENSES

Possibility of mounting optical lenses CORRECTION -1.0 up to -8.00

OPTICAL LENSES INSTALLATION \$ 5.00

SYMMETRICAL LENSES

The lenses are positive for correcting negative dioptres (myopia)

COMPLETE INFORMATION

OPTICAL LENSES
Please refer to page 337

CODE	PRODUCT
D1240010	Optical Lens -1.0
D1240015	Optical Lens -1.5
D1240020	Optical Lens -2.0
D1240025	Optical Lens -2.5
D1240030	Optical Lens -3.0
D1240035	Optical Lens -3.5
D1240040	Optical Lens -4.0
D1240045	Optical Lens -4.5
D1240050	Optical Lens -5.0
D1240055	Optical Lens -5.5
D1240060	Optical Lens -6.0
D1240065	Optical Lens -6.5
D1240070	Optical Lens -7.0
D1240075	Optical Lens -7.5
D1240080	Optical Lens -8.0



SUPEROCCHIO



Superocchio is the grand classic in the Cressi line, it is still a favorite among many divers through its many years of availability. Superocchio is small, compact and provides low internal volume, which makes it a great choice for deep diving and spearfishing due to its low internal volume, which allows for minimal effort from the diver to comfortably equalize during descent.

The allergy free black silicone skirt protects the divers eyes from unwanted back glare and distraction while spearing. The soft silicone mask strap comes with easy and quick adjusting buckles to help provide a comfortable precise fit and can be easily manageable even when wearing neoprene gloves.

CODE	COLOR	CASE PACK
DN234650	Black/Black	6

MINIMA 2022 VINTAGE

THE LOWEST VOLUME ON THE MARKET



This mask was designed specifically for deep sea diving, with innovative features that place it at the top of its category. The special reduced skirt, complete with a small seal ring, sticks like a suction cup to the face, leaving minimum air space inside the mask, which make compensation extremely easy, taking very little air from the lungs.

The lens-eye distance is the absolute smallest on the market and guarantees, even with small diameter lenses, excellent visibility in all directions.

The two optic glass lenses are thicker than the standard to allow a special safety mould.

The strap comes with instantly adjusting buckles for an easy and precise fit.

CODE	COLOR	CASE PACK
DS292050	Black/Black	6



TECHNICAL FEATURES

- Low internal volume
- Inverted teardrop lenses shape
- Very light



TECHNICAL FEATURES

- **Materials:** liquid silicone, hi-tech polymers
- **Strap buckles:** instant adjustment
- Internal very low volume
- **Frame dimension:** 168 x 45 mm
- **Weight:** 118 g | 4.1 oz

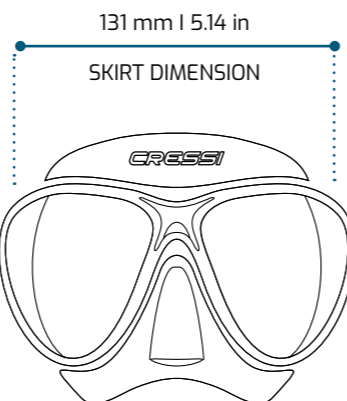

PERLA

A mask particularly suitable for freediving and snorkeling, but just as appropriate for use in scuba diving.

It has separate lenses, a skirt edge fitting most of the faces and a small inner volume, perfect for freedivers.

It is made from soft transparent or dark silicone for a better comfort and a perfect seal. It comes with strong rapid action buckles to adjust the length strap.

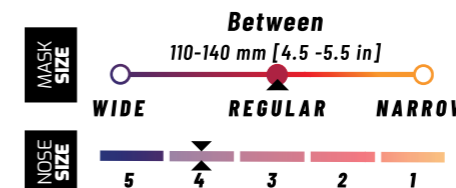
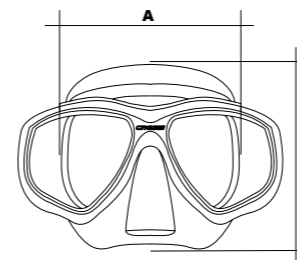

CODE	COLOR	CASE PACK
DN208150	Black/Black	12
DN208198	Dark Green	12



TECHNICAL FEATURES

- Inverted teardrop inclined lenses for increased downwards visibility
- Skirt made in hypoallergenic quality silicone
- 2 tempered lens made in tempered glass
- Easy-to-use buckles for quickly strap length adjustment



PRODUCT DIMENSION CHART (SKIRT SIZE)

A WIDTH (mm)	B HEIGHT (mm)	A WIDTH (in)	B HEIGHT (in)
122	105	4 13/16	4 2/16

CRESSI'S SIZE CHART IS TO BE USED AS A REFERENCE ONLY

PACIFICO

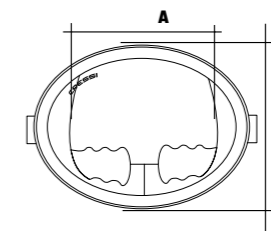

RUBBER MASK

TECHNICAL FEATURES

- Single-lens in a classic retro oval shape
- Scratch-resistant tempered glass for clarity and safety
- Rubber skirt and strap for great seal and comfort
- Easily adjustable buckles



PRODUCT DIMENSION CHART (SKIRT SIZE)

A WIDTH (mm)	B HEIGHT (mm)	A WIDTH (in)	B HEIGHT (in)
120	110	4 12/16	4 15/16

CRESSI'S SIZE CHART IS TO BE USED AS A REFERENCE ONLY

CALIBRO & CORSICA

| CALIBRO MASK + CORSICA SNORKEL



BLUE METAL BLACK GREEN

TECHNICAL FEATURES

- Designed specifically for Deep Freediving and Spearfishing
- Low internal volume allows the diver less effort to equalize
- Black allergy free Silicone Skirt to prevent back reflection
- Tempered glass lenses
- Easily adjustable mask strap and buckles
- Skirt Design allows for fit of a multitude of face types



CODE	COLOR	CASE PACK
DS434550	Blue Metal	10
DS435050	Black	10
DS439850	Green	10

PERLA & MEXICO

| PERLA MASK + MEXICO SNORKEL



CODE	COLOR	CASE PACK
DM102017	Black	10



TECHNICAL FEATURES

- The multi-positional silicone soft mouthpiece provides extreme comfort during prolonged use
- Large diameter Snorkel Tube provides unobstructed ease of breathing
- Minimal tube and mouthpiece bends provides easier clearing capability

ZS1 & CORSICA NEW 2022

| ZS1 MASK + CORSICA SNORKEL



TURQUOISE PINK FLUO

TECHNICAL FEATURES

- Low-volume, single lens design for a wide field-of-view
- **Frameless:** silicone skirt bonds directly to the lens for lower weight and reduced drag
- Fast-adjust ratcheting strap buckles mounted to skirt
- High-grade silicone seals

ZS1 is the small version, suitable for adults with small faces, of the Z1, a frameless mask that boasts a low internal volume while offering a wide field of view in all directions. The specific design uses the assembly of the silicone skirt directly over the single glass. This system guarantees great sturdiness and a perfect watertight seal.

The lower weight of the mask makes it ideal for travel. The flexible fit and reduced drag are appreciated for freediving and spearfishing, snorkeling and diving. The micrometrically adjustable buckles are comfortable and effective.

CODE	COLOR	CASE PACK
DM372828	ZS1 & CORSICA - TURQUOISE	5
DM374545	ZS1 & CORSICA - PINK FLUO	5



CORSICA



Ideal
with mask
METIS
Hunter line

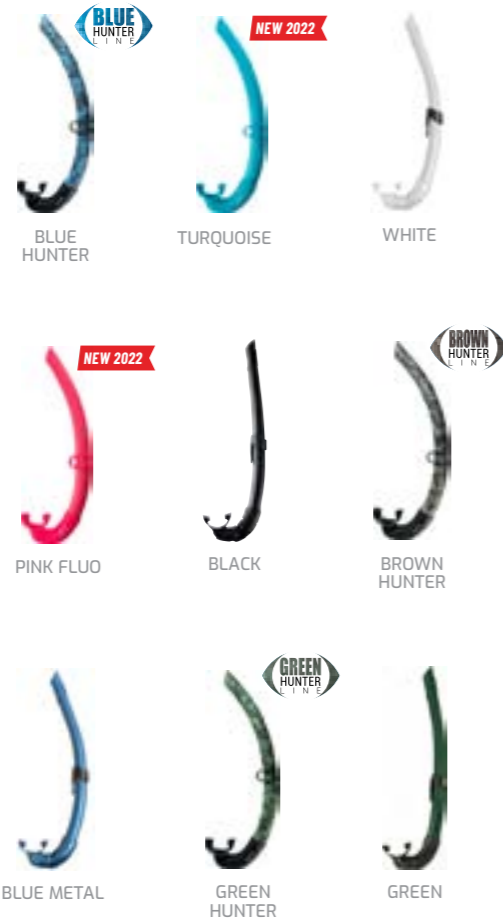

TECHNICAL FEATURES

- Anatomical hypoallergenic Silicone Mouthpiece provides extreme comfort during prolonged use
- Soft bendable Snorkel Tube to maintain proper and comfortable positioning
- Large diameter Snorkel Tube provides unobstructed ease of breathing
- Specially designed and molded U-Bend
- Provides easier clearing capability



POLYBAG



ULTRA FLEXIBLE TUBE

Corsica is a highly technical snorkel designed specifically for deep freediving and spearfishing. The soft bendable large diameter tubing makes it extremely comfortable to properly position behind the head while maintaining ease of breathing on the surface. When diving, the mouthpiece tucks neatly under the chin for the

ultimate in hydrodynamics. The anatomical hypoallergenic silicone mouthpiece provides extreme comfort during long duration in the water. The Corsica is available in either solid or camouflage color and is an excellent choice for the discriminating diver who is looking for the best equipment.

CODE	COLOR	CASE PACK
EG268523	Camo Blue	12
EG268528	Turquoise	12
EG268530	White	12
EG268545	Pink Fluo	12
EG268550	Black/Black	12
EG268553	Camo Brown	12
EG268555	Blue	12
EG268593	Camo Green	12
EG268598	Green/Black	12

AMERICA



CODE	CASE PACK
EG267050	12

TECHNICAL FEATURES

- The multi-positional silicone soft mouthpiece provides extreme comfort during prolonged use
- Large diameter Snorkel Tube provides unobstructed ease of breathing
- Minimal tube and mouthpiece bends provides easier clearing capability



POLYBAG

GRINGO



CODE	CASE PACK
EG266000	12

TECHNICAL FEATURES

- The multi-positional silicone soft mouthpiece provides extreme comfort during prolonged use
- Large diameter Snorkel Tube provides unobstructed ease of breathing
- Minimal tube and mouthpiece bends provides easier clearing capability



POLYBAG

7-12° C
44.6-53.6° F
CE CERTIFICATION
DIVING WETSUIT
EN 14225-1:2017: A

8mm
CE

FISTERRA NEW 2022

| TWO-PIECE WETSUIT 8 MM

TECHNICAL FEATURES

- Two-piece wetsuit
- Ultra durable neoprene



JACKET WITHOUT ZIPPERS HIGH TROUSERS



X-PLUSH ELASTIC TERRY LOOP



ELASTIC PLUSH INSIDE



Robust wetsuit also ideal for commercial fishing. Fisterra was originally born in version 8mm, to respond to the need of professional divers in cold waters. The demand for professional divers, diving instructors and users who demand maximum thermal performance and comfort has encouraged us to incorporate a 5 mm version for temperate waters into the collection.

Fisterra 5 mm is a resistant, very watertight and highly thermal combination with jacket without zippers and high trousers with dungarees. A combination that combines, therefore, characteristics that place it at the

apex of pure performance in a wetsuit of this thickness. Low-compression LC neoprene that guarantees

optimum thermal protection at the bottom due to its high resistance to compression ideal for professional work or long duration diving. Nylon outer lining of high weight very resistant, interior X-Plush elastic terry loop, waterproof and great sliding that facilitates the placement and removal of the suit at the same time has a large thermal memory. Wide anti-abrasion knee-spin pads and elbow pads in Supratex®.

CODE	SIZE	CASE PACK
LK489502	S	5
LK489503	M	5
LK489504	L	5
LK489505	XL	5
LK489506	2XL	5
LK489507	3XL	5



WETSUITS

FREEDIVING



50 YEARS
MANUFACTURE
QUALITY SINCE
1946

Photo by Roberto D'Anna

16-24° C
60.8-75.2° F
CE CERTIFICATION
DIVING WETSUIT
EN 14225-1:2017: C

3 mm

10-18° C
50-64.4° F
CE CERTIFICATION
DIVING WETSUIT
EN 14225-1:2017: B

5 mm

ULTRASOFT
NEOPRENE

SPECIALIZED
Retailer Product

LAMPUGA

NEW 2022

| TWO-PIECE WETSUIT



TECHNICAL FEATURES

- Preformed anatomical cut
- Jacket with padded reinforcement on the chest
- Watertight seals in smooth skin on hood, wrists and ankles
- Reinforced anti-abrasion lining on the chest and knees
- High-waisted trousers with watertight seals on the ankles and waist

SMOOTH SKIN WATERTIGHT SEALS



CHEST REINFORCEMENT



AQUA STOP SYSTEM



PROTECTIVE REINFORCEMENT



SINGLE PIECE UNDERARM SECTION



Inspired by the livery of the pelagic fish. A special digital printing system has been used for this new camouflage wetsuit, allowing high resolution images to be obtained and thus create an exclusive camouflage design. The new "Cryptic Camouflage Technology" of Cressi is based

on a real image of a fish (a dolphin fish in this case, with its dominant colours), to create camouflage that is very close to the original and then altered to obtain a repetitive effect that is one of a kind. The materials used are: high elastic camo on the outside, open-cell neoprene on the inside.

3 mm

CODE	SIZE	CASE PACK
LU490112	S	5
LU490113	M	5
LU490114	L	5
LU490115	XL	5
LU490116	2XL	5
LU490117	3XL	5

5 mm

CODE	SIZE	CASE PACK
LU490102	S	5
LU490103	M	5
LU490104	L	5
LU490105	XL	5
LU490106	2XL	5

16-24° C
60.8-75.2° F
CE CERTIFICATION
DIVING WETSUIT
EN 14225-1:2017: C

5 mm

10-18° C
50-64.4° F
CE CERTIFICATION
DIVING WETSUIT
EN 14225-1:2017: B

7 mm

SEPPIA

NEW 2022

| TWO-PIECE WETSUIT



SMOOTH SKIN WATERTIGHT SEALS



KNEEPAD



CHEST REINFORCEMENT



PROTECTIVE REINFORCEMENT



SINGLE PIECE UNDERARM SECTION



When wet changes colour accentuating mimetism!

Wetsuit created with the exclusive new Cressi green/brown camouflage, computer-designed to make it more difficult for prey to create solid images, thereby confusing the wearer with the background.

Performed anatomical cut. Jacket with padded reinforcement on the chest. Smooth skin with watertight seals on hood, wrists, and ankles. Reinforced anti-abrasion lining on the chest and knees. High-waisted trousers with watertight seals on the ankles and waist.

5 mm

CODE	SIZE	CASE PACK
XLE468502	S	5
XLE468503	M	5
XLE468504	L	5
XLE468505	XL	5
XLE468506	2XL	5

7 mm

CODE	SIZE	CASE PACK
XLE468702	S	5
XLE468703	M	5
XLE468704	L	5
XLE468705	XL	5
XLE468706	2XL	5

 >22° C >71.6° F CE CERTIFICATION DIVING WETSUIT EN 14225-1:2017: D	3.5 mm	 16-24° C 60.8-75.2° F CE CERTIFICATION DIVING WETSUIT EN 14225-1:2017: B	5 mm	 10-18° C 50-64.4° F CE CERTIFICATION DIVING WETSUIT EN 14225-1:2017: B	7 mm
---	--------	---	------	---	------



APNEA NEW 2022

| TWO-PIECE WETSUIT



A well-cut suit with particular attention to comfort around the areas where the body suffers most friction. Internal layer in metallic

black and a thickness of 3.5 mm and 5 mm. New design of the loading/reloading chestplate and special kneepads for extra protection.

3.5 mm

CODE	SIZE	CASE PACK
LE450102	S	5
LE450103	M	5
LE450104	L	5
LE450105	XL	5
LE450106	2XL	5
LE450107	3XL	5

5 mm

CODE	SIZE	CASE PACK
LE450202	S	5
LE450203	M	5
LE450204	L	5
LE450205	XL	5
LE450206	2XL	5
LE450207	3XL	5

7 mm

CODE	SIZE	CASE PACK
LE450302	S	5
LE450303	M	5
LE450304	L	5
LE450305	XL	5
LE450306	2XL	5
LE450307	3XL	5

TECHNICAL FEATURES

- Made of black-metallite Neoprene
- Chest reinforcement
- Knee pads
- Interior in open cell Neoprene

PROTECTIVE REINFORCEMENT



CHEST REINFORCEMENT



KNEEPAD



HIGH WAISTED TROUSERS



TOKUGAWA

| 2-PIECE WITH HOOD

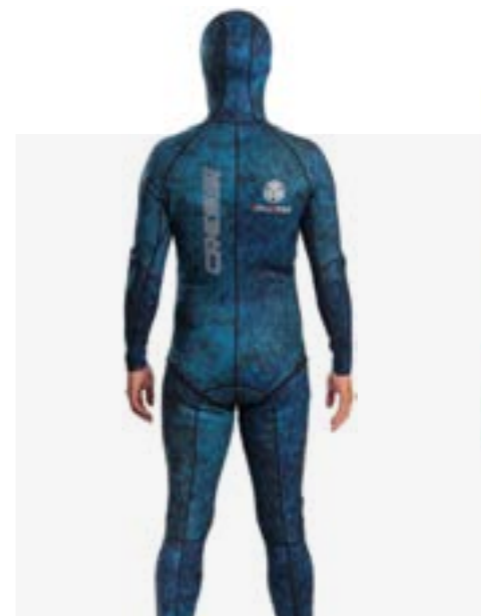

TECHNICAL FEATURES

- Blue camouflage pattern
- Anatomical cuts
- Chest loading pads
- Knee pads
- Interior reinforced with Nylon

BACK ZIP



CHEST REINFORCEMENT



KNEEPAD



The Tokugawa wetsuit is an excellent spearfishing and freediving wetsuit. It was designed by the Cressi Australia team, with the knowledge and help of the Italian Cressi family, based on the market-leading Apnea wetsuit pattern. It was designed specifically for use in blue waters as a perfect hardwearing spearfishing and pool training suit. The unique camouflage adapts to different water

environments – from the blue waters of the Caribbean Sea to the greener tones of the Northern USA. It is manufactured with flexible, comfortable, soft neoprene. This material is designed for flexibility.

This wetsuit is named in honor of the Tokugawa shogunate – The Tokugawa shogunate was the last feudal Japanese military government, which existed between 1600 and 1868.

Open Cell 3.5 mm NEW 2022

CODE	SIZE	CASE PACK
LU490022	S	5
LU490023	M	5
LU490024	L	5
LU490025	XL	5
LU490026	2XL	5
LU490027	3XL	5

Nylon Closed Cell 2 mm

CODE	SIZE	CASE PACK
LU490032	S	5
LU490033	M	5
LU490034	L	5
LU490035	XL	5
LU490036	2XL	5
LU490037	3XL	5

TOKUGAWA

| MONOPIECE WETSUIT



Designed for blue water spearfishing Tokugawa, named after the Japanese feudal shogunate, is a one-piece 3 mm thick wetsuit, perfect for spearfishing, freediving and swimming, as well as for open water and pool training. The unique camouflage of this wetsuit is appropriate for different aquatic environments, from the blue waters of the Caribbean Sea to the greener tones of North American waters. The wetsuit's graphics provide the ultimate in camouflage for all environments. Tokugawa,

which is made of elastic, flexible, comfortable and soft neoprene, has an anatomically designed cut specific to Cressi wetsuits, with preformed arms and legs that improve wearability and movement in the water. The chest and the knee pad reinforcements are designed specifically for spearfishing. The Dura Stretch nylon lining improves the wetsuit's elasticity, comfort and durability.

3 mm

CODE	SIZE	CASE PACK
LU490002	S	10
LU490003	M	10
LU490004	L	10
LU490005	XL	10
LU490006	2XL	10
LU490007	3XL	10

TECHNICAL FEATURES

- For spearfishing, freediving
- Camouflage design
- Rear zipper

BACK ZIP

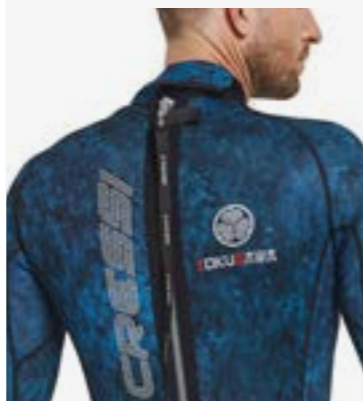

CHEST REINFORCEMENT



KNEEPAD



COBIA

| EXTRA WARMTH TOP RASHGUARD

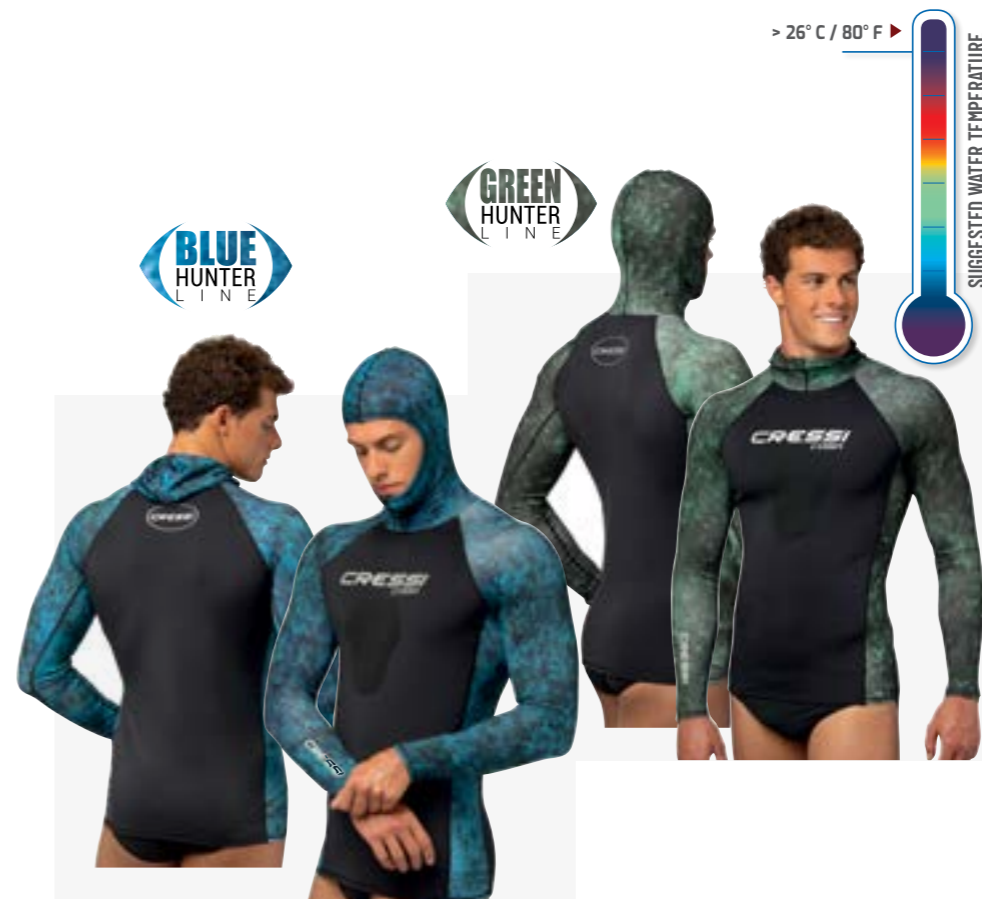

> 26° C / 80° F

SUGGESTED WATER TEMPERATURE

TECHNICAL FEATURES

- Chest in quality Neoprene 1mm
- Hood and sleeves made of rash guard fabric
- Wearable under wetsuit
- Excellent anatomic cuts
- Available in Cressi's mimetic pattern blue or green

> NEOPRENE CHEST chest pad

KNEEPAD



SMOOTH SKIN WATERTIGHT SEALS



The Cobia is the ultimate rash guard that features a chest area completely made in 1 mm premium Neoprene to provide extra warmth. It's hooded to give the opportunity to protect and to heat also the head.

The Cobia can be worn under a wetsuit to give more warmth and protection. Can be used in any water sports, from windsurfing to scuba diving.

Blue

CODE	COLOR	SIZE	CASE PACK
USW01102B	Camo Blue	S	10
USW01103B	Camo Blue	M	10
USW01104B	Camo Blue	L	10
USW01105B	Camo Blue	XL	10
USW01106B	Camo Blue	2XL	10
USW01107B	Camo Blue	3XL	10

Green

CODE	COLOR	SIZE	CASE PACK
USW01120G	Camo Green	S	10
USW011203G	Camo Green	M	10
USW011204G	Camo Green	L	10
USW011205G	Camo Green	XL	10
USW011206G	Camo Green	2XL	10
USW011207G	Camo Green	3XL	10

HUNTER RASH GUARD

| LOADING CHEST PAD



TECHNICAL FEATURES

- Camo patterns for blue water and reef environments
- Excellent anatomical cuts
- Upf u/v rays protection

CHEST PAD



The Hunter is a rash guard made with strong and elastic synthetic fabric. Made with anatomical cuts and can be worn in any water sports. Protects from wind and from UPF Ultraviolet rays. The chest is

seamless and features a soft durable pad that protects the body. Can be worn over a wetsuit that does not have chest loading pad. Available in Cressi's mimetic patterns.

Blue

CODE	COLOR	SIZE	CASE PACK
USW010102B	Camo Blue	S	5
USW010103B	Camo Blue	M	5
USW010104B	Camo Blue	L	5
USW010105B	Camo Blue	XL	5
USW010106B	Camo Blue	2XL	5
USW010107B	Camo Blue	3XL	5

Green

CODE	COLOR	SIZE	CASE PACK
USW010202G	Camo Green	S	5
USW010203G	Camo Green	M	5
USW010204G	Camo Green	L	5
USW010205G	Camo Green	XL	5
USW010206G	Camo Green	2XL	5
USW010207G	Camo Green	3XL	5

CONCH DYFIBER NEW 2022

Cressi designed a glove that provides high comfort and dexterity while being cut and puncture resistant, making it ideal for Lobstering and Spearfishing. The wrist closer will always keep the glove in place, regardless of normal use expansion from water weight.

Lime

CODE	SIZE	CASE PACK
PQ100707	XS	10
PQ100708	S	10
PQ100709	M	10
PQ100710	L	10
PQ100711	XL	10
PQ100712	2XL	10

Blue

CODE	SIZE	CASE PACK
PQ100701	XS	10
PQ100702	S	10
PQ100703	M	10
PQ100704	L	10
PQ100705	XL	10
PQ100706	2XL	10

HEX GRIP NEW 2022

Cressi designed a glove that provides high comfort and dexterity while being cut puncture and impact-resistant, making it ideal for Lobstering and Spearfishing. The wrist closer will always keep the glove in place, regardless of normal use expansion from water weight.

Lime

CODE	SIZE	CASE PACK
PQ100607	XS	10
PQ100608	S	10
PQ100609	M	10
PQ100610	L	10
PQ100611	XL	10
PQ100612	2XL	10

Blue

CODE	SIZE	CASE PACK
PQ100601	XS	10
PQ100602	S	10
PQ100603	M	10
PQ100604	L	10
PQ100605	XL	10
PQ100606	2XL	10

HUNTER GLOVES

| 2MM

The Hunter Gloves are 5 fingers gloves made with premium quality Elastic Neoprene. This fabric provides high elasticity and comfort giving the possibility to use the complete movements of the fingers.

Camo Blue

CODE	SIZE
USW022501	S
USW022502	M
USW022503	L
USW022504	XL

Camo Green

CODE	SIZE
LX477901	S
LX477902	M
LX477903	L
LX477904	XL

TECHNICAL FEATURES

- Cressi's Dyfiber material offers maximum strength with minimum weight.
- High-performance polyethylene and stainless steel
- The Sandy Nitrile palm provides outstanding grip in dry, wet, and oily conditions.
- 30% Sandy Nitrile, 48% HPPE, 8% Stainless Steel, 6% Nylon, 4% Polyester, 2% Spandex, 2% PVC.



» 4 CUT RESISTANCE LEVEL
» 3 PUNCTURE RESISTANCE LEVEL

TECHNICAL FEATURES

- Technical features
- Cressi's glove materials offer maximum strength with minimum weight.
- High-performance polyethylene and stainless steel
- The Sandy Nitrile palm provides outstanding grip in dry, wet, and oily conditions.



» 4 CUT RESISTANCE LEVEL
» 3 PUNCTURE RESISTANCE LEVEL



HUNTER SOCKS

| 3 MM

Very soft and super supple socks made of 3-mm Elastic-Span neoprene. They have a honeycomb reinforcing and anti-slip coating on the sole. The Black-Metallite lining makes them easier to put on.

SIZE CONVERSION CHART			
SIZE	EU FOOT SIZE	US MEN'S FOOT SIZE	US WOMEN'S FOOT SIZE
S	36 / 38	5 / 6.5	6 / 7.5
M	39 / 40	7 / 8	8 / 9
L	41 / 43	9 / 10.5	10 / 11.5
XL	44 / 46	11 / 12.5	12 / 13.5

Camo Blue

CODE	SIZE	CASE PACK
USW020201	S	5
USW020202	M	5
USW020203	L	5
USW020204	XL	5

Camo Green

CODE	SIZE	CASE PACK
LX433211	S	5
LX433212	M	5
LX433213	L	5
LX433214	XL	5



ANTI-SLIP SOCKS

| 2.5 MM

These are single-lined, thin, high stretch neoprene socks. The inner is lined in Metallite so they are easy to put on. The sole has an effective non-slip lining. They can be used with both closed foot fins for greater warmth and to protect the skin from scratches and chafing, as well as with firm-soled socks, using open-heel fins. In this case, warmth is considerably increased and it is also easier to put on your wetsuit.

SIZE CONVERSION CHART			
SIZE	EU FOOT SIZE	US MEN'S FOOT SIZE	US WOMEN'S FOOT SIZE
S	36 / 38	5 / 6.5	6 / 7.5
M	39 / 40	7 / 8	8 / 9
L	41 / 43	9 / 10.5	10 / 11.5
XL	44 / 46	11 / 12.5	12 / 13.5

CODE	SIZE	CASE PACK
LX433001	S	10
LX433002	M	10
LX433003	L	10
LX433004	XL	10

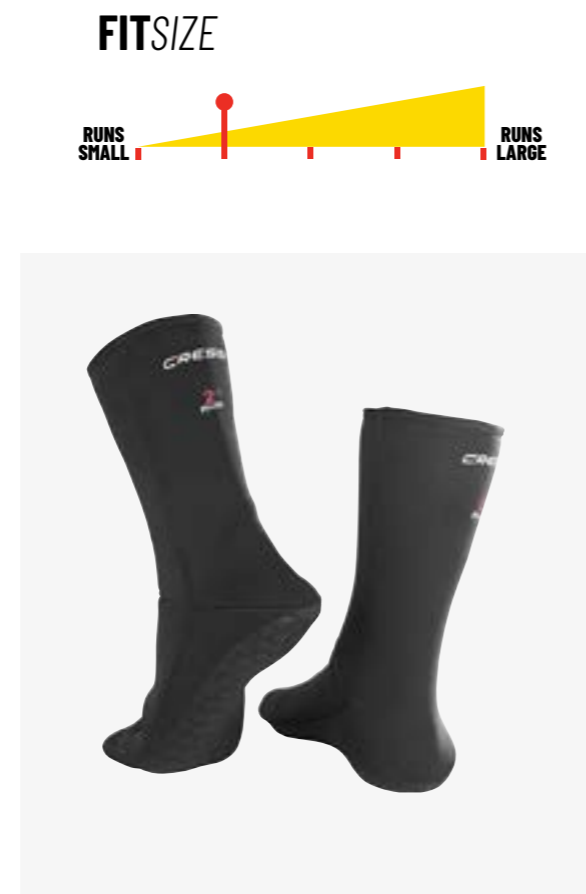

FREEDIVING TRAINING BUOY



TECHNICAL FEATURES

- Outer bag made of 1050 Denier Cordura fabric
- Inner bladder with inflator valve
- 4 TPR lateral handles
- 2 lateral stainless steel D-rings
- Underneath central large stainless steel D-ring for rope connection
- Large storage compartment with Velcro closure

Dedicated to freediving lovers. It has a durable external material, an external zipper pocket, 4 external handles for pre-immersion preparation, and 2 exterior D-rings. The wide interior space allows storing the rope during transport. The inner bladder features a

valve offering the choice of oral inflation or the use of an inflator hose. The freediving rope can be connected to the underneath stainless steel D-ring. The red diving flag is included to be seen from distance. Made of durable 1050 Denier Cordura fabric.

CODE

TA611990

TORPEDO PRO BUOY FLOAT

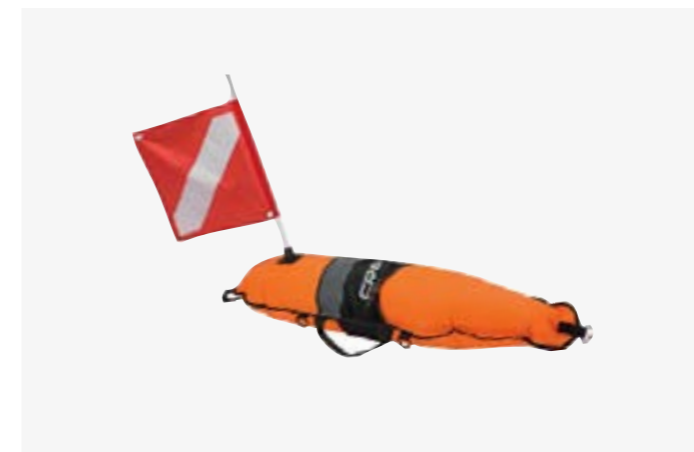

CODE	DEALER	ASSOCIATE	MASTER	PARTNER	MAP
TA611603	28.18	26.77	25.36	23.95	49.95



HUNTER SWIVEL SNAP CLIP



DESCRIPTION: The Snap Clip is made in stainless steel to ensure strength. It features a swivel to be knotted to a float line. It is ideal to be mounted on butt of gun for float line connection. It has an ideal size for buoy connections.

CODE

FA390037

FLOAT ROPE



DESCRIPTION: Length: 98.5 ft | 30 m, Strength: 330.7 lb | 150 kg. **Thickness (diameter):** 0.24 in | 6 mm, **Style of braiding:** weave Long rope of 100 ft (approx.) made in strong polyethylene for use as an accessory for freediving or spearfishing. The rope is composed by weaving a group of 16 twists each consisting of 6 thin wires of 0.25mm diameter twisted together.

CODE

TA613530

WEIGHT BELT

These are single-lined, thin, high stretch neoprene socks. The inner is lined in Metallite so they are easy to put on. The sole has an effective non-slip lining. They can be used with both closed foot fins for greater warmth and to protect the skin from scratches and chafing, as well as with firm-soled socks, using open-heel fins. In this case, warmth is considerably increased and it is also easier to put on your wetsuit.

CODE	PRODUCTS	CASE PACK
UW100000	METAL BUCKLE - BLACK	10
UW100001	METAL BUCKLE - NEON YELLOW	10
TA627020	HARD PLASTIC BUCKLE - BLUE	10



ELASTIC BELT

CODE	PRODUCTS	CASE PACK
TA626000	PREMIUM MARSEILLAISE RUBBER BELT BLACK	10
TA626010	QUICK-RELEASE ELASTIC BELT W/ METAL BUCKLE - BLACK	10
XTA626011	QUICK-RELEASE ELASTIC BELT W/ METAL BUCKLE - YELLOW	10
XTA626020	QUICK-RELEASE ELASTIC BELT W/ METAL BUCKLE - BLUE	10



WEIGHT KEEPER

CODE	PRODUCTS	CASE PACK
TA627100	WEIGHT BELT KEEPER - BLACK (5 PACK) BLACK	10
TA627101	WEIGHT BELT KEEPER - STAINLESS STEEL (2 PACK) SILVER	10



LIBRA BALLAST WEIGHT BAG

The Libra is the bag for carrying the ballast needed for your scuba diving equipment. It can carry also the weights used by the freedivers. It is made in strong and resistant Denier fabric, for long-lasting use and for a huge weight. Built rugged, the double webbing encircles the entire bag for added strength and joins to form a padded handle.

CODE
UB500550



TECHNICAL FEATURES

- Made in strong and resistant Denier fabric
- Double-slider zipper
- Personal tag compartment

BAGS



Photo by Jordi Ribot

WATERPROOF POLYESTER | EXTERNAL WATERPROOF POCKET | 120 L

TUNA DRY

| WHEELED OVERSIZED BAG

120
LITERS



The Tuna Dry Wheel Bag is an ideal bag for transporting any kind of equipment for water activities keeping protected from water. It has a capacity of 120 liters | 4.23 cu ft that can fit also long freediving fins. Made of highly resistant materials, it allows you to keep your equipment dry and protect electronic devices. Equipped with central handles/shoulder straps and side handles to facilitate transport even though the presence of wheels. The presence of wheels facilitates

transport even on long routes. A practical waterproof side pocket keeps small items dry and protects electronic devices. Internal straps with clip closure allow you to secure the sports equipment during transport. Made of very resistant materials, with well-finished stitching. The lower part is reinforced, shockproof and insulating. Waterproof seal. Keep your equipment dry, protect electronic devices and documents from water, dust, and sand.

CODE	CASE PACK
XUB976200	2

	DIMENSION (LENGTH-WIDTH-HEIGHT)		VOLUME		WEIGHT	
	CM	IN	LITER	CU FT	KG	LB
TUNA	40 x 41 x 95	37 1/2 x 15 3/4 x 16 1/8	120	4.23	3.5 kg	7 lb 11 oz



TECHNICAL FEATURES

- Made of polyester
- External pocket
- Side handles and shoulder straps

INSIDE STRAPS



WITH WHEELS



SEMI RIGID CASE



TECHNICAL FEATURES

- Made from a strong radio frequency (RF) welded seam PVC
- Waterproof fabric
- Durable straps for carrying any style
- 2 Shoulder straps and handle straps on both ends of the bag
- Draining cap for washing bag and equipment
- Strong YKK zipper
- Front zipped pocket

WATER RESISTANT ZIPPER | HIGH FREQUENCY WELDING | FOR GARA FINS | 135 L

GORILLA PRO

| HEAVY-DUTY WATERPROOF GEAR BAG

135
LITERS



BLACK

CAMO BLUE

CAMO GREY

One large and roomy bag. The bag is long enough to hold even the long freediving fins. It is made from a strong radio frequency (RF) welded seam PVC and is waterproof. Equipment can be washed with water while still inside the bag. Once you have finished washing your gear, the bag has a special

draining cap situated at one end to let water out easily and conveniently. Comes with handy top grab carry handles and two straps that can also be used as shoulder straps. No water comes out when transported, even by car.

ELECTRONICALLY WELDED



SPECIAL DRAINING CAP



TOP VIEW



HIGH VOLUME



CODE	COLOR	CASE PACK
UA925710	Black	10
XUA925798	Camo Blue	10
XUA925799	Camo Grey	10

	DIMENSION (LENGTH-WIDTH-HEIGHT)		VOLUME		WEIGHT	
	CM	IN	LITER	CU FT	KG	LB
GORILLA XL	95 x 34 x 42	37 x 13 x 16	135	4.77	1.5 kg	3.5 lb 5 oz

DRY GARA BACKPACK

| HIGH-VOLUME DRY BACKPACK

60
LITERS



TECHNICAL FEATURES

- Waterproof polyester
- External waterproof pocket

2 X GUN-HOLDER



FIN-HOLDER



SIDE VIEW



BACK VIEW



Comfortable watertight daypack made of black highly resistant PVC. It is the ideal bag for carrying your equipment in any challenging situation, even on a motorcycle.

It has side fasteners for carrying spear guns and a special front pocket for storing long fins.

CODE	SIZE	CASE PACK
UA925800	60 liters	10

	DIMENSION (LENGTH-WIDTH-HEIGHT)		VOLUME		WEIGHT	
	CM	IN	LITER	CU FT	KG	LB
DRY GARA	39.5 x 23.5 x 66	15 x 9 x 26	60	2.12	1.12 kg	2 lb 7.5 oz



PIOVRA XL

85
LITERS



TECHNICAL FEATURES

- Made of 900/600 Denier with 6P Free coating
- **Backstrap material:** 900 Denier reversed
- SBS 10# zipper
- **Bottom:** anti-skid material
- **Lining:** 210 Denier

» New taller version to accommodate the Gara Modular Impulse



The Piovra XL is a special backpack conceived for transporting spearfishing and freediving gears. It features a main compartment big enough for storing a pair of long fins (up to 39 in / 100 cm) equipped with a netting for ventilation. It is possible to store a wetsuit, mask, snorkels, belt and various spearfishing gear. Zip closing with 2 zippers with eyelet for padlocks.

The Piovra has a secondary cooler-type compartment for storing cold drinks or fishes.

The front has a zigzag elastic cord with an adjustable locker ideal for quick storage. Both sides have two elastic bands that are ideal for securing two spearguns. When the bag is empty it is possible to reduce the volume thanks to the lateral compression straps.

The shoulder straps have the buckle chest strap height adjustable. Side handle.

Wear-resistant bottom. Top hook for hanging the bag.

CODE	CASE PACK
XV8990101	10

	DIMENSION (LENGTH-WIDTH-HEIGHT)		VOLUME		WEIGHT	
	CM	IN	LITER	CU FT	KG	LB
PIOVRA XL	30 x 30 x 130	11 3/4 x 11 3/4 x 44	85	3.00	1.6 kg	3 lb 8 oz

GARA PREMIUM BAG

A newly renovated version of the Gara Bag. The unique and functional bag with the necessary space to store fins, mask and snorkel. The famous Gara fins, the long freediving fins, can be accommodated easily in this shoulder bag for comfortable and secure transportation.

The bottom part is made with a strong mesh which allows water to drain. Practical front pocket with zip closure for storing personal stuff. It features a padded adjustable shoulder strap.



CODE	CASE PACK
UB931081	5

TECHNICAL FEATURES

- Nylon 600 denier
- Front pocket

LONG FIN SET BAG



The Long Fins Set Bag is a functional bag with the necessary space to store fins, mask and snorkel.

Also longer fins such as Gara are

accommodated easily in this shoulder bag for comfortable and secure transportation. Bag is made from durable nylon material.

CODE
US451031

TECHNICAL FEATURES

- Nylon 600 denier
- Front pocket
- › Dimension
- › Height: 94 cm, 37.0 in
- › Width: 24.5 cm, 9.6 in
- › Length: 17.5 cm, 6.9 in



CRESSI SPEARFISHING 2022 COLLECTION

With this catalogue, we would like to highlight our origins, which have distinguished us over the years. Today, with the same passion as then, we follow the needs of our customers, from the beginners to the most ambitious athletes, sure of providing products suitable for all needs, always focusing on technology and results.

In these 75 years the company has always preserved its DNA, which is well represented by Cressi logo. The "C" logo with the mermaid, in the origin with the speargun, is recognisable all over the world as a prestigious brand of watersports and spearfishing.

Our goal is to provide a complete vision of our products Dedicated to all those who make spearfishing their passion.

The work undertaken over the years carries out a constant renewal of products with strict testing and always new technologies, placing us at the top for reliability, performance and durability.

All this takes in thanks to a continuous dialogue between our designers, who are always ready to make the best improvements, and our ambassadors, expert testers who have made the sea their home.

The philosophy of the Cressi family is always the same, first of all the technique and then everything else... this catalogue is an excellent example.

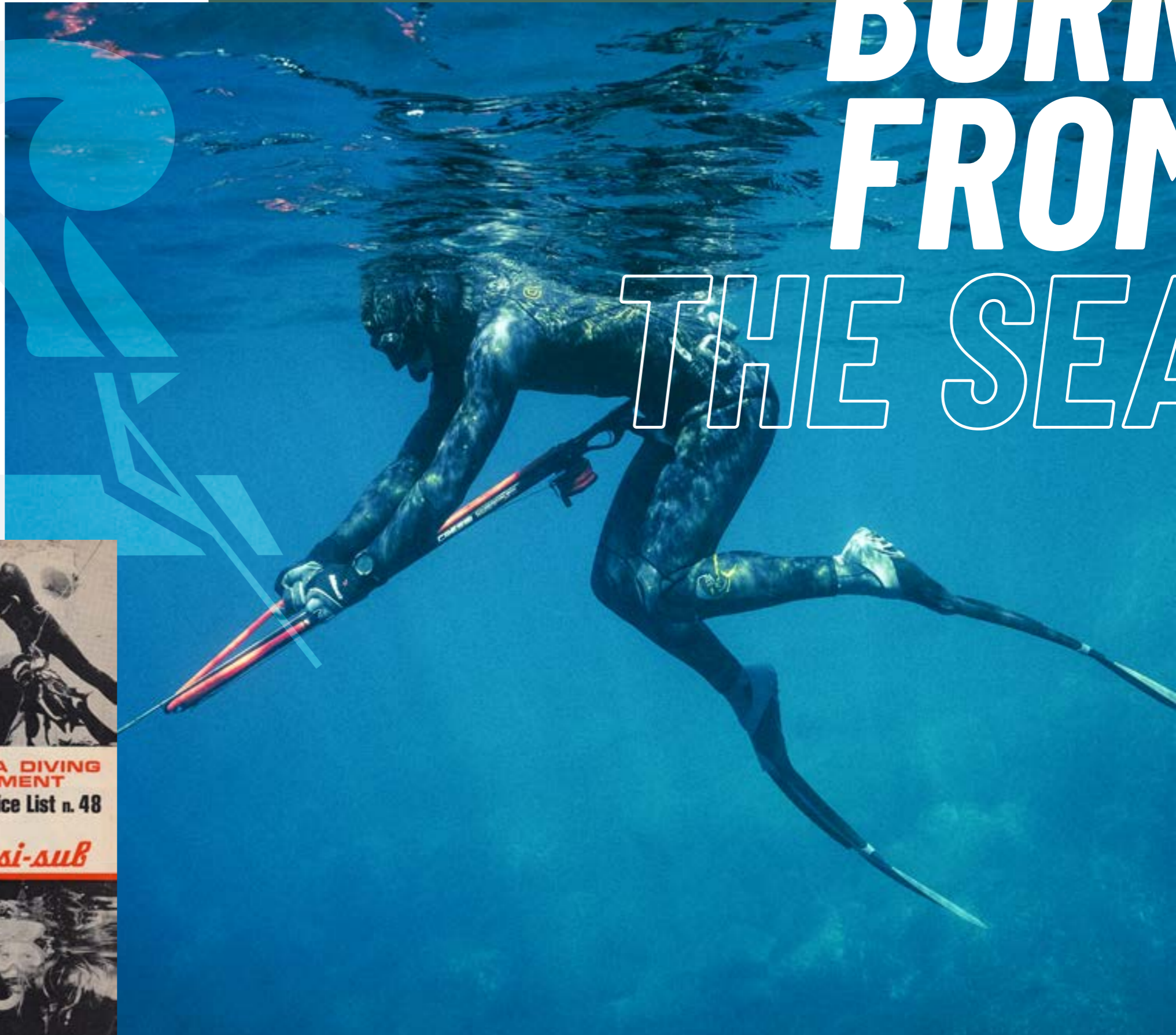

BORN FROM THE SEA



Photo by: Marcello Postonasi

SPEARFISHING | SPEARGUNS



35 WE
MANUFACTURE
QUALITY SINCE
1946

CHEROKEE POWER NEW 2022

| UNLIMITED POWER



TECHNICAL FEATURES

- Ultra light release box and trigger
- Lateral guide line release with automatic return
- Interchangeable high-low sternal support
- Shaft \varnothing 7 mm with tig welded and drilled fins and reversed flopper
- Quick loading magnetic open muzzle
- Double circular band \varnothing 16 mm with a 2 mm lined wishbone
- Rigged barrel \varnothing 28 mm with shaft guide

FINNED SHAFT \varnothing 7 MM WITH BOTTOM FLOPPER



QUICK LOADING MAGNETIC OPEN MUZZLE



DOUBLE CIRCULAR BAND \varnothing 16 MM



SHOCK ABSORBER



RIGGED AND REINFORCED BARREL WITH SHAFT GUIDE



INTERCHANGEABLE HIGH-LOW SUPPORT



ULTRA LIGHT HANDLE



Anticorrosive black frame with integrated spear guide, grip made of engineering plastic reinforced with glass fibre, high or low soft sternal support. Composite material release mechanism with trigger, release tooth and lateral guide line release obtained from the base. The shock absorber makes silent the release of the shaft. Reversible side safety

mechanism. Reinforced reel with steel pin buckle. Head for double elastic with magnetic spear lock: as soon as the spear is put in place, it is held by two magnets mounted in a watertight chamber. This characteristic guarantees maximum speed of reset without the disadvantages of conventional mechanical restraint systems.

CODE	SIZE	CASE PACK
FE365200	90 cm	6
FE365300	100 cm	6
FE365400	110 cm	6
FE365500	120 cm	6
FE365600	130 cm	6

ACCESSORIES

CODE	PRODUCT
FA359050	REEL R50
FA359030	REEL R30

SPARE PARTS

CODE	PRODUCT	GUN LENGTH
FA406120	INOX FINNED SHAFT \varnothing 7mm BT. FLOPPER (120 cm)	90 cm
FA406130	INOX FINNED SHAFT \varnothing 7mm BT. FLOPPER (130 cm)	100 cm
FA406140	INOX FINNED SHAFT \varnothing 7mm BT. FLOPPER (140 cm)	110 cm
FA406150	INOX FINNED SHAFT \varnothing 7mm BT. FLOPPER (150 cm)	120 cm
FA406160	INOX FINNED SHAFT \varnothing 7mm BT. FLOPPER (160 cm)	130 cm
FA400525	CIRCULAR BAND w/LW \varnothing 16mm ID3.2mm - BLUE (63cm) (GUN 100)	100 cm
FA400526	CIRCULAR BAND w/LW \varnothing 16mm ID3.2mm - BLUE (69cm) (GUN 110)	110 cm
FA400527	CIRCULAR BAND w/LW \varnothing 16mm ID3.2mm - BLUE (77cm) (GUN 120)	120 cm
FA400528	CIRCULAR BAND w/LW \varnothing 16mm ID3.2mm - BLUE (81cm) (GUN 130)	130 cm
FB1532162	BAND RUBBER TUBING 50FT - BLUE - \varnothing 16mm - \varnothing ID 3.2	

CHEROKEE FAST

| POWERFUL WITH EASY LOADING



ULTRA LIGHT HANDLE

REEL INCLUDED



Anticorrosion black frame with integrated spear guide. Grip made of engineering plastic reinforced with glass fibre. High or low soft sternal support. Composite material release mechanism with a trigger, release tooth and lateral guide line release obtained from the base. The shock absorber makes silent the release of the shaft. Reversible side-safety

mechanism. Reinforced reel with steel pin buckle. Head for double elastic with magnetic spear lock: as soon as the spear is put in place. It is held by two magnets mounted in a watertight chamber. This characteristic guarantees maximum speed of reset without the disadvantages of conventional mechanical restraint systems.

CODE	SIZE	CASE PACK
FE363100	75 cm	6
FE363200	90 cm	6
FE363300	100 cm	6
FE363400	110 cm	6
FE363500	120 cm	6

READYFORUSE MADE IN ITALY

TECHNICAL FEATURES

- Anticorrosion black barrel with integrated spear guide
- Handle made of engineering plastic reinforced with fiberglass
- Adjustable ergonomic handle, two screws allow you to set a larger or smaller handle
- Sideline release integrated into the body of the gun
- Cobra design open-muzzle featuring softer angles for reducing friction with the bands
- **Muzzle with the spear-lock system:** two magnets keep the shaft in position
- Shock absorber for silencing the release of the shaft
- Reel included featuring a quick-release mounting bracket
- Choice between two sternal supports, one long and one short
- Supplied with two elastic bands with nylon cord (Ø 14mm) and a stainless steel shaft (Ø 6 mm)

FINNED SHAFT Ø 6.5 MM WITH BOTTOM FLOPPER



QUICK LOADING MAGNETIC OPEN MUZZLE



DOUBLE CIRCULAR BAND Ø 14 MM



INTERCHANGEABLE HIGH-LOW SUPPORT



SPARE PARTS

CODE	PRODUCT	GUN LENGTH
FA404903	INOX FINNED SHAFT Ø 6.5mm BT. FLOPPER [105 cm]	75 cm
FA404904	INOX FINNED SHAFT Ø 6.5mm BT. FLOPPER [120 cm]	90 cm
FA404905	INOX FINNED SHAFT Ø 6.5mm BT. FLOPPER [130 cm]	100 cm
FA404906	INOX FINNED SHAFT Ø 6.5mm BT. FLOPPER [140 cm]	110 cm
FA404907	INOX FINNED SHAFT Ø 6.5mm BT. FLOPPER [150 cm]	120 cm
FA400483	CIRCULAR BAND w/LW Ø 14mm ID3.2mm - RED [48cm] (GUN 75)	120 cm
FA400484	CIRCULAR BAND w/LW Ø 14mm ID3.2mm - RED [57cm] (GUN 90)	120 cm
FA400485	CIRCULAR BAND w/LW Ø 14mm ID3.2mm - RED [63cm] (GUN 100)	120 cm
FA400486	CIRCULAR BAND w/LW Ø 14mm ID3.2mm - RED [69cm] (GUN 110)	120 cm
FA400487	CIRCULAR BAND w/LW Ø 14mm ID3.2mm - RED [77cm] (GUN 120)	120 cm
FB15168	BAND RUBBER TUBING 50FT - RED - Ø 16mm - ØID 1.6	



CHEROKEE EXO

| MODULAR POWER



Ultra light release box and trigger

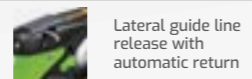

Lateral guide line release with automatic return



Anticorodal black frame with integrated spear guide, grip made of engineering plastic reinforced with glass fibre, high or low soft sternal support. Ultra-light triggering case with trigger, release mechanism and line ring on the side in AISI 316, machined from solid with a CNC process. The shock absorber makes silent the release of the shaft. Reversible side-safety mechanism. Reinforced reel with steel pin buckle.

Head for double elastic with magnetic spear lock: as soon as the spear is put in place, it is held by two magnets mounted in a watertight chamber. This characteristic guarantees maximum speed of reset without the disadvantages of conventional mechanical restraint systems. The speargun is supplied with a 16 mm natural latex elastic, with Dyneema wishbone.

CODE	SIZE	CASE PACK
FE364000	60 cm	6
FE364100	75 cm	6
FE364200	90 cm	6
FE364300	100 cm	6
FE364400	110 cm	6

READYFORUSE MADE IN ITALY

TECHNICAL FEATURES

- Ultra light release box and trigger
- Lateral guide line release with automatic return
- Interchangeable high-low sternal support
- Shaft Ø 6.5 mm
- Quick loading magnetic open muzzle
- Circular band Ø 16 mm with lined wishbone 2 mm
- Rigged barrel Ø 28 mm with shaft guide
- **Measurements:** 110, 100, 90, 75 & 60 cm

QUICK LOADING MAGNETIC OPEN MUZZLE



SHOCK ABSORBER



RIGGED AND REINFORCED BARREL WITH SHAFT GUIDE



INTERCHANGEABLE HIGH / LOW SUPPORT



28 mm



ULTRA LIGHT HANDLE



ACCESSORIES

CODE	PRODUCT
FA359050	REEL R50
FA359030	REEL R30

SPARE PARTS

CODE	PRODUCT	GUN LENGTH
FA404902	INOX FINNED SHAFT Ø 6.5mm BT. FLOPPER [90 cm]	60 cm
FA404903	INOX FINNED SHAFT Ø 6.5mm BT. FLOPPER [105 cm]	75 cm
FA404904	INOX FINNED SHAFT Ø 6.5mm BT. FLOPPER [120 cm]	90 cm
FA404905	INOX FINNED SHAFT Ø 6.5mm BT. FLOPPER [130 cm]	100 cm
FA404906	INOX FINNED SHAFT Ø 6.5mm BT. FLOPPER [140 cm]	110 cm
FA400562	CIRCULAR BAND w/LW Ø 16mm ID3.2mm - LIME [39cm] (GUN 60)	60 cm
FA400563	CIRCULAR BAND w/LW Ø 16mm ID3.2mm - LIME [48cm] (GUN 75)	75 cm
FA400564	CIRCULAR BAND w/LW Ø 16mm ID3.2mm - LIME [57cm] (GUN 90)	90 cm
FA400565	CIRCULAR BAND w/LW Ø 16mm ID3.2mm - LIME [63cm] (GUN 100)	100 cm
FA400566	CIRCULAR BAND w/LW Ø 16mm ID3.2mm - LIME [69cm] (GUN 110)	110 cm
FB1532169	BAND RUBBER TUBING 50FT - GREEN - Ø16mm - ØID 3.2	



TIG WELDED SHARK FINS AND FLOPPER

RIGGED BARREL WITH SHAFT GUIDE

28 mm

CIRCULAR BAND Ø MM 16 WITH LINED WISHBONE 2 MM

QUICK LOADING MAGNETIC OPEN MUZZLE

SHAFT Ø MM 6.5

YUMA FAST NEW DESIGN 2022

| THE GUN FOR AMBUSH AND DEN



Anticorrosive black frame with integrated spear guide, grip made of engineering plastic reinforced with glass fiber, integrated soft sternal support. Ultra-light triggering case with a release mechanism in AISI 316. Dovetail reel coupling. Head for double elastic with magnetic spear lock: as soon

as the spear is put in place, it is held by two magnets mounted in a watertight chamber. This characteristic guarantees maximum speed of reset without the disadvantages of conventional mechanical restraint systems. The speargun is supplied with a double 14 mm natural latex band, with a Dyneema wishbone.

CODE	SIZE	CASE PACK
FE349000	60 cm	6
FE349100	75 cm	6
FE349200	90 cm	6
FE349300	100 cm	6

READYFORUSE **MADE IN ITALY**

TECHNICAL FEATURES

- Guide line release with automatic return
- Integrated sternal support
- Shaft ø 6 mm with tig welded fins and reversed flopper
- Quick loading magnetic open muzzle
- Circular band ø 14 mm with a 2 mm lined wishbone
- Rugged barrel ø 26 mm with shaft guide

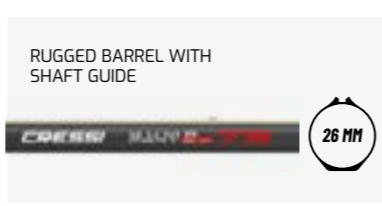
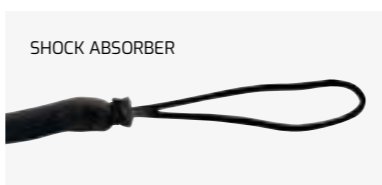

SPARE PARTS

CODE	PRODUCT	GUN LENGTH
FA407090	INOX FINNED SHAFT Ø 6mm BT. FLOPPER (90 cm)	60 cm
FA407105	INOX FINNED SHAFT Ø 6mm BT. FLOPPER (105 cm)	75 cm
FA407120	INOX FINNED SHAFT Ø 6mm BT. FLOPPER (120 cm)	90 cm
FA407130	INOX FINNED SHAFT Ø 6mm BT. FLOPPER (130 cm)	100 cm
FA400483	CIRCULAR BAND w/LW Ø 14mm ID3.2mm - RED (48cm) (GUN 75)	120 cm
FA400484	CIRCULAR BAND w/LW Ø 14mm ID3.2mm - RED (57cm) (GUN 90)	120 cm
FA400485	CIRCULAR BAND w/LW Ø 14mm ID3.2mm - RED (63cm) (GUN 100)	120 cm
FA400486	CIRCULAR BAND w/LW Ø 14mm ID3.2mm - RED (69cm) (GUN 110)	120 cm
FA400487	CIRCULAR BAND w/LW Ø 14mm ID3.2mm - RED (77cm) (GUN 120)	120 cm
FB1532148	BAND RUBBER TUBING 50FT - RED - Ø 14mm - ØID 3.2	



COMANCHE RAIL

| THE HISTORY OF OUR SPEARGUNS



The Comanche Rail is the latest version of Cressi's world champion spear gun. The high-strength, anti-corrosion aluminum barrel now features an integrated guide rail for increased accuracy. The high-tech and lightweight modern thermoplastic hand grip and muzzle guarantee the utmost maneuverability in the water, adding to the Comanche Rail's accuracy. The compact and hydrodynamic muzzle makes it possible to add a second lower band to increase power for larger prey. The muzzle

and handgrip are configured so the shooter can easily acquire a sight picture of the gun while simultaneously tracking their target. The Comanche Rail comes with a heat-treated 6.0 mm spring stainless steel 17-4 PH notched shaft, 16 mm parallel power bands, metal articulated wishbone, and a shaft rigged to the gun with a 1.4 mm braided multifilament line rated to 80 kg | 176 lb. The Comanche Rail also features a dovetail notch in front of the trigger guard, allowing a reel to be mounted.

CODE	SIZE	CASE PACK
FE359000	60 cm	6
FE359100	75 cm	6
FE359200	90 cm	6
FE359300	100 cm	6
FE359400	110 cm	6

ACCESSORIES

CODE	PRODUCT
FA359050	REEL R50
FA359030	REEL R30

SPARE PARTS

CODE	PRODUCT	GUN LENGTH
FA410002	INOX NOTCHED SHAFT Ø 6mm [90cm]	60 cm
FA410003	INOX NOTCHED SHAFT Ø 6mm [105cm]	75 cm
FA410004	INOX NOTCHED SHAFT Ø 6mm [115cm]	90 cm
FA410005	INOX NOTCHED SHAFT Ø 6mm [125cm]	100 cm
FA410006	INOX NOTCHED SHAFT Ø 6mm [130cm]	110 cm
FA400002	PARALLEL BAND Ø 16mm [16cm]	60 cm
FA400003	PARALLEL BAND Ø 16mm [18.5cm]	75 cm
FA400005	PARALLEL BAND Ø 16mm [22cm]	90 cm
FA400006	PARALLEL BAND Ø 16mm [25.5cm]	100 cm
FA400007	PARALLEL BAND Ø 16mm [27.5cm]	110 cm



READYFORUSE MADE IN ITALY

TECHNICAL FEATURES

- Anti-corrosion aluminum barrel with a shaft guide
- Lightweight angled handle to increase shot's precision
- Hydrodynamic closed muzzle
- Dovetail notch for reel assembling

NOTCHED SHAFT Ø 6.0 MM



ULTRA COMPACT CLOSED MUZZLE QUICKLOAD MINI SPEARHEAD



Ø 16 MM PARALLEL BANDS WITH METAL WISHBONE



RUGGED AND REINFORCED BARREL WITH SHAFT GUIDE



SPECIAL HANDLE ANGLE TO INCREASE THE SHOT'S PRECISION



READYFORUSE MADE IN ITALY

APACHE

| ROBUST AND MINIMALIST



Apache is Cressi's entry level speargun and can also be handily used as a second gun. This gun is an excellent choice when fishing in holes, around rocks, shallows and where the target is in close proximity. The Apache incorporates a closed muzzle, which helps with ease of loading and improved

accuracy. The sealed barrel is anodized for enhanced corrosion resistance, while the ergonomic molded handle permits easier maneuverability and quick muzzle pointing. The power band is fitted with a standard stainless wishbone and the gun includes the widely preferred Tahitian style flopper shaft.

TECHNICAL FEATURES

- Ergonomic molded handle for easier maneuverability
- Durable anodized heavy duty sealed aluminum barrel
- Closed muzzle for improved accuracy and ease of loading
- Advanced Tahitian-style flopper shaft for superior penetration
- Replaceable band and wishbone assembly is user friendly

SPECIAL HANDLE ANGLE TO INCREASE THE SHOT'S PRECISION



Ø 6.5 MM NOTCHED THREADED SHAFT



CLOSED MUZZLE



BARREL Ø 26 MM



Ø 13 MM CIRCULAR BAND WITH METAL WISHBONE



CODE	SIZE	CASE PACK
FE341035	35 cm	6
FE341045	45 cm	6
FE341060	60 cm	6
FE341075	75 cm	6
FE341090	90 cm	6

SPARE PARTS

CODE	PRODUCT	GUN LENGTH
FA350535	STEEL NOTCHED THREADED SHAFT Ø 7.0 mm [65 cm]	35 cm
FA350545	STEEL NOTCHED THREADED SHAFT Ø 7.0 mm [75 cm]	45 cm
FA350560	STEEL NOTCHED THREADED SHAFT Ø 7.0 mm [90cm]	60 cm
FA350575	STEEL NOTCHED THREADED SHAFT Ø 7.0 mm [105 cm]	75 cm
FA350590	STEEL NOTCHED THREADED SHAFT Ø 7.0 mm [115 cm]	90 cm
FA340019	CIRCULAR BAND Ø 13 mm [24 cm] GUN 35	35 cm
FA340020	CIRCULAR BAND Ø 13 mm [31 cm] GUN 45	45 cm
FA340021	CIRCULAR BAND Ø 13 mm [34 cm] GUN 60	60 cm
FA340022	CIRCULAR BAND Ø 13 mm [39 cm] GUN 75	75 cm
FA340023	CIRCULAR BAND Ø 13 mm [44 cm] GUN 90	90 cm
FA390002	INOX SPEAR HEAD MONO-FLOPPER Ø 6.5mm THREAD	
FA350020	JOINTED WISHBONE TYPE A	

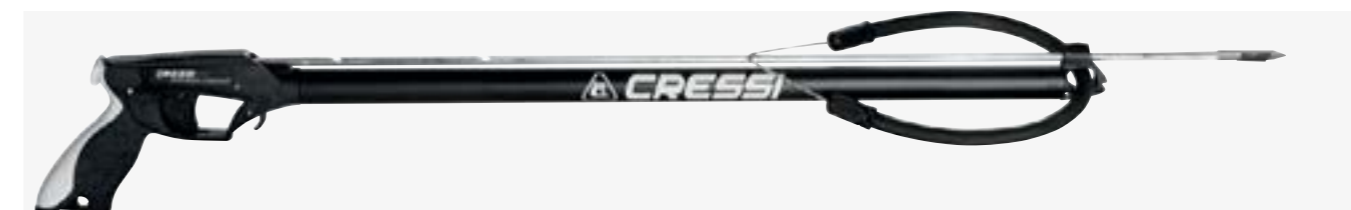

SLING GUN SHAFTS



17-4 PH SHAFT FINNED Ø 7 mm

BOTTOM FLOPPER



NEW 2022

CODE	SIZE	CASE PACK
FA406120	120 cm	6
FA406130	130 cm	6
FA406140	140 cm	6
FA406150	150 cm	6
FA406160	160 cm	6

17-4 PH SHAFT FINNED Ø 6.5 mm

BOTTOM FLOPPER



NEW 2022

CODE	SIZE	CASE PACK
FA404902	90 cm	6
FA404903	105 cm	6
FA404904	120 cm	6
FA404905	130 cm	6
FA404906	140 cm	6
FA404907	150 cm	6

17-4 PH SHAFT FINNED Ø 6 mm

BOTTOM FLOPPER

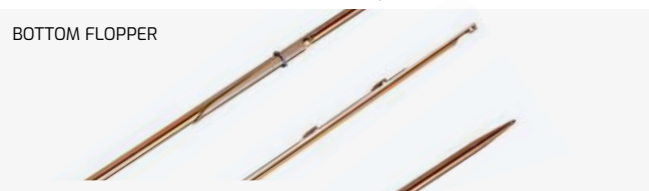

NEW 2022

CODE	SIZE	CASE PACK
FA407090	90 cm	6
FA407105	105 cm	6
FA407120	120 cm	6
FA407130	130 cm	6

INOX FINNED Ø 7 mm

TOP FLOPPER



CODE	SIZE	CASE PACK
FA405103	115 cm	6
FA405104	130 cm	6
FA405105	140 cm	6
FA405106	150 cm	6
FA405107	160 cm	6

STAINLESS STEEL NOTCHED Ø 6.5 mm

TOP FLOPPER



CODE	SIZE	CASE PACK
FA410501	75 cm	6
FA410502	90 cm	6
FA410503	105 cm	6
FA410504	115 cm	6
FA410505	125 cm	6
FA410506	130 cm	6
FA410507	140 cm	6
FA410508	150 cm	6



SLING GUN SHAFTS

17-4 PH SHAFT NOTCHED Ø 6.5 mm

TOP FLOPPER



CODE	SIZE	CASE PACK
FA410002	90 cm	6
FA410003	105 cm	6
FA410004	115 cm	6
FA410005	125 cm	6
FA410006	130 cm	6
FA410007	140 cm	6
FA410008	150 cm	6

INOX FINNED THREADED Ø 7 mm

Ø 6 MM THREAD

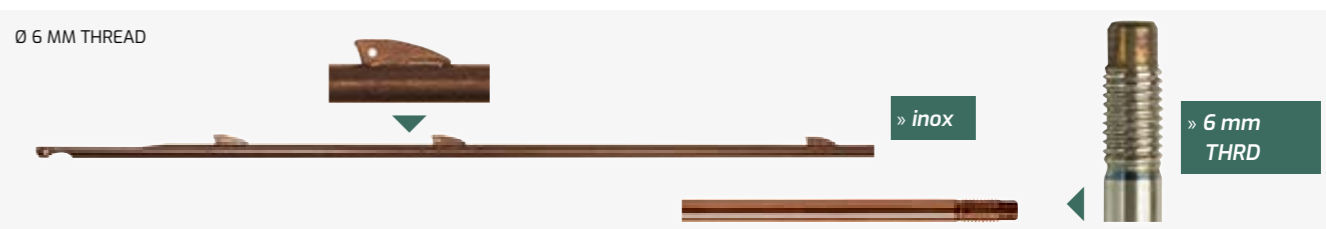

CODE	SIZE	CASE PACK
FA405203	115 cm	6
FA405204	130 cm	6
FA405205	140 cm	6
FA405206	150 cm	6
FA405207	160 cm	6

STEEL NOTCHED THREADED SHAFT Ø 7 mm

Ø 6 MM THREAD



CODE	SIZE	CASE PACK
FA350535	65 cm	6
FA350545	75 cm	6
FA350560	90 cm	6
FA350575	105 cm	6
FA350590	115 cm	6

CONVERSION CHART

Inches	>	Millimeters	:	Multiply By 25.4
Inches	>	Centimeters	:	Multiply By 2.54
Feet	>	Meters	:	Multiply By 0.3048
Pounds	>	Grams	:	Multiply By 454

in	15/64"	9/32"	5/16"	15/32"	1/2"	9/16"	5/8"	3/4"
mm	6	7	8	12	13	14	16	19

in	13.77	15.74	17.71	21.65	23.62	27.55	29.52	33.46	35.43	37.40	39.37	41.33	43.30	45.27	47.24
cm	35	40	45	55	60	70	75	85	90	95	100	105	110	115	120

SLIP TIP

| + FLOPPER + RETAINER

The Slip Tip has a Flopper and a Retainer. Designed with a Tahitian Style Point. It is made of stainless steel 17-4 PH H900 heat treatment.

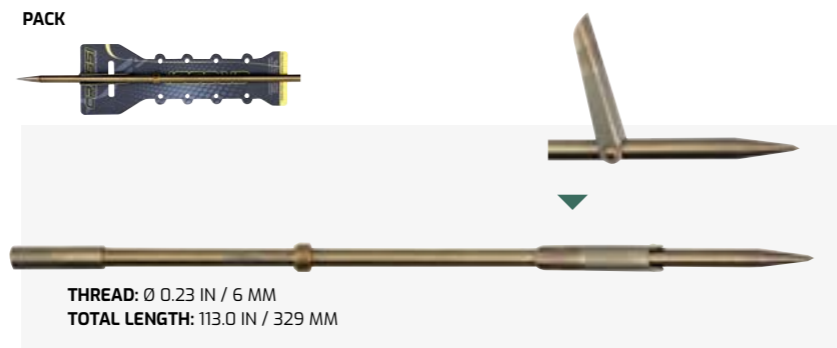

THREAD: Ø 0.23 IN / 6 MM
TOTAL LENGTH: 113.0 IN / 329 MM

CODE	PRODUCT	CASE PACK
USX021100	SLIP TIP 6 mm + FLOPPER - THREAD - 17-4 PH + CABLE 2 mm	10

TRICUT TIP W/ FLOPPER

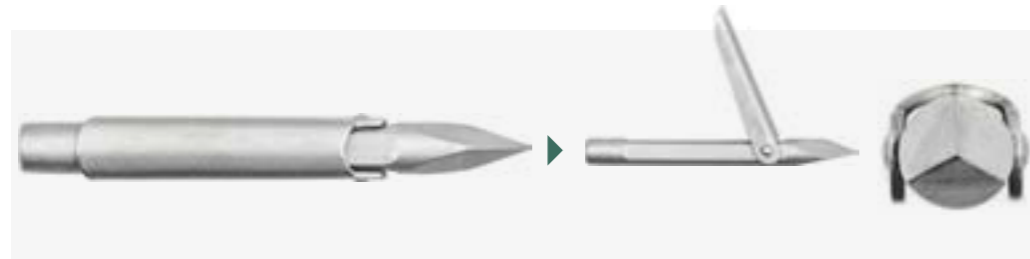

TECHNICAL FEATURES

- Three cutting edges hand sharpened tip with a robust flopper, ideal for big prey.
- Made of stainless steel 17-4 PH H900 heat treatment. Sandblasting finishing.
- Thread: Ø 8 mm | 0.31 in
- Total length: 88 mm | 3.46 in

CODE	PRODUCT	SIZE
USX021105	TRICUT TIP w/ FLOPPER 9 mm (5/16") - 17-4PH 6 mm THREAD	9 mm

INOX SPEAR HEAD MONO-FLOPPER



CODE	PRODUCT
FA390002	INOX SPEAR HEAD MONO-FLOPPER ø 6.5mm THREAD



RUBBER BAND TUBING 50 FT



DESCRIPTION: Reinforced internal tube, bigger density (shore 45°) to maximize the resistance to pressure of the ball over the internal walls of the rubber.

DESCRIPTION: Reinforced internal tube, bigger density (shore 45°) to maximize the resistance to pressure of the ball over the internal walls of the rubber.

DESCRIPTION: Reinforced internal tube, bigger density (shore 45°) to maximize the resistance to pressure of the ball over the internal walls of the rubber.

CODE	COLOR	SIZE	STYLE	CASE PACK
FB1516142	Blue	50 ft 15 m	Ø 14mm - ØID 1.6	1
FB1516145	Black	50 ft 15 m	Ø 14mm - ØID 1.6	1
FB1516148	Red	50 ft 15 m	Ø 14mm - ØID 1.6	1
FB1516162	Blue	50 ft 15 m	Ø 16mm - ØID 1.6	1
FB1516165	Black	50 ft 15 m	Ø 16mm - ØID 1.6	1
FB1516168	Red	50 ft 15 m	Ø 16mm - ØID 1.6	1
FB1532142	Blue	50 ft 15 m	Ø 14mm - ØID 3.2	1
FB1532145	Black	50 ft 15 m	Ø 14mm - ØID 3.2	1
FB1532148	Red	50 ft 15 m	Ø 14mm - ØID 3.2	1
FB1532162	Blue	50 ft 15 m	Ø 16mm - ØID 3.2	1
FB1532165	Black	50 ft 15 m	Ø 16mm - ØID 3.2	1
FB1532168	Red	50 ft 15 m	Ø 16mm - ØID 3.2	1
FB1532169	Green	50 ft 15 m	Ø 16mm - ØID 1.6	1
FB1532182	Blue	50 ft 15 m	Ø 18mm - ØID 3.2	1
FB1532185	Black	50 ft 15 m	Ø 18mm - ØID 3.2	1
FB1532188	Red	50 ft 15 m	Ø 18mm - ØID 3.2	1

CIRCULAR BAND w / LW Ø 16 mm



CODE	COLOR	SIZE	STYLE
FA400524	Blue	57 cm	Ø 16 mm - ØID 3.2
FA400525	Blue	63 cm	Ø 16 mm - ØID 3.2
FA400526	Blue	69.5 cm	Ø 16 mm - ØID 3.2
FA400527	Blue	77 cm	Ø 16 mm - ØID 3.2
FA400528	Blue	81 cm	Ø 16 mm - ØID 3.2
FA400562	Lime	39 cm	Ø 16 mm - ØID 3.2
FA400563	Lime	48 cm	Ø 16 mm - ØID 3.2
FA400564	Lime	57 cm	Ø 16 mm - ØID 3.2
FA400565	Lime	63 cm	Ø 16 mm - ØID 3.2
FA400566	Lime	69 cm	Ø 16 mm - ØID 3.2

CIRCULAR RUBBER BAND



PURE DYNEEMA
HIGH STRENGTH.
200KG (TENSILE STRENGTH)

CODE	SIZE	STYLE	CASE PACK
FA400113	48 cm	Ø 18 mm	1
FA400114	57 cm	Ø 18 mm	1
FA400115	63 cm	Ø 18 mm	1
FA400116	69.5 cm	Ø 18 mm	1
FA400153	47 cm	Ø 16 mm	1
FA400154	58 cm	Ø 16 mm	1
FA400155	63 cm	Ø 16 mm	1
FA400156	69 cm	Ø 16 mm	1
FA400157	75 cm	Ø 16 mm	1

DESCRIPTION: Designed to use with Finned Shaft. Stainless steel spheres 7 mm maximum diameter; (bottleneck with lock out 2mm in diameter). This design ensures the lock without forcing the knot too much and limiting the internal pressure on the rubber.

CIRCULAR BAND

| Ø 16 MM | Ø 13 MM

BAND: Ø 5/8 in / 16 mm
THREAD: Ø 15/32 in / 12 mm
BAND: Ø 1/2 in / 13 mm
THREAD: Ø 15/32 in / 12 mm



CODE	SIZE	STYLE	CASE PACK
FA400302	34 cm	Ø 16 mm	6
FA400303	45 cm	Ø 16 mm	6
FA400304	50 cm	Ø 16 mm	6
FA400305	55 cm	Ø 16 mm	6
FA340019	26 cm	Ø 13 mm	6
FA340020	31 cm	Ø 13 mm	6
FA340021	34 cm	Ø 13 mm	6
FA340022	39 cm	Ø 13 mm	6
FA340023	44 cm	Ø 13 mm	6

DESCRIPTION:

The rubber, in black color, is made from 100% natural latex by gravity extrusion, to maintain constant the diameter and so the mechanical properties of the band. The diameter of the band is 13mm. The diameter of the thread is 12mm.

CIRCULAR BAND w / LW Ø 14 mm

| Ø 14 MM



CODE	COLOR	SIZE	STYLE
FA400483	Red	48 cm	Ø 14 mm - ØID 3.2
FA400484	Red	57 cm	Ø 14 mm - ØID 3.2
FA400485	Red	63 cm	Ø 14 mm - ØID 3.2
FA400486	Red	69 cm	Ø 14 mm - ØID 3.2
FA400487	Red	77 cm	Ø 14 mm - ØID 3.2

PARALLEL COMPETITION ELASTIC

| Ø 16 MM



BAND: Ø 5/8 in / 16 mm
THREAD: Ø 15/32 in / 12 mm

CODE	SIZE	STYLE	CASE PACK
FA400001	14 cm	Ø 16 mm	6
FA400002	16 cm	Ø 16 mm	6
FA400003	18.5 cm	Ø 16 mm	6
FA400004	20 cm	Ø 16 mm	6
FA400005	22 cm	Ø 16 mm	6
FA400006	22.5 cm	Ø 16 mm	6
FA400007	27.5 cm	Ø 16 mm	6

DESCRIPTION:

The rubber, in black color, is made from 100% natural latex by gravity extrusion, to maintain constant the diameter and so the mechanical properties of the band.



REELS

| DOVETAIL MOUNTING SYSTEM

These reel models are constructed from a single piece of metal which is worked by a high precision lathe. There are no welds to ensure excellent performance and long life. The frame and the central pin are in AISI 316 steel. The drilling on the frame itself allows it to be used also on arbalete spearguns of different brands. The special clutch

provides an excellent closing torque. The assembly system allows easy maintenance and cleaning. All sizes are equipped with a rewinder ring and size R50 is also equipped with an anti-blocking roller. The models R30 and R50 are equipped with a lightened drum in order to weigh as little as possible on the balance of the speargun.

TECHNICAL FEATURES

- Ideal for shooting big fish
- Prevents loss of the speargun
- Smooth multi-adjustable clutch style drag system
- Ergonomic easily accessible star adjusting knob



R20

DESCRIPTION: 65 ft - 20 m with line Ø 1.5 mm
 CHEROKEE (ANY MODEL) · MOICANO · COMANCHE RAIL · YUMA FAST · KIOWA · SIOUX · PACIFICO

CODE
 FA359020



R30

DESCRIPTION: 100 ft - 30 m with line Ø 1.5 mm

CODE
 FA359030



R50

DESCRIPTION: 160 ft - 50 m with line Ø 1.5 mm

CODE
 FA359050

REEL

| FISHING REEL



TECHNICAL FEATURES

- Durable-and-Effective
- Smooth Multi-Adjustable Clutch Style Drag System
- Clutch Style Drag System, Adjustable when Paying-
- Out Line
- Ergonomic Easily Accessible Star Adjusting Knob
- Vertical Mount Design for Minimal Drag
- Material: Non-Corrosive, Durable and Impact
- Resistant Plastic
- Dimension: 10.9 x 15 x 9.4 centimeters

Reels are an essential accessories for spearfishing big fish. Prevents fish and gun loss. It's constructed from non-corrosive, durable and impact resistant plastic. The dovetail sleigh hook system to the gun

is placed so that the use of the different line-releasing devices is guaranteed, including the mechanical one activated by the trigger.

DESCRIPTION: 130 ft - 40 m with line Ø 1.5 mm
 DOVETAIL MOUNTING SYSTEM CHEROKEE OCEAN - COMANCHE 2.0 - YUMA - MOHICANO

CODE
 FA359001

HIGH TENACITY LINE



DESCRIPTION: Diameter: 2.5 mm
 Length: 200 mt

CODE
 FA390030

WISHBONE STANDARD



CODE
FA350022

JOINTED WISHBONE TYPE -A 3 PRONGS SPEAR HEAD



CODE
FA350020



CODE
FA390008

COMPETITION NYLON THREAD 180



DESCRIPTION: Diameter: 1.80 mm
Length: 5 m | 16.4 ft
2 sleeves included

CODE
FA354524

COMPETITION NYLON THREAD 160



DESCRIPTION: Diameter: 1.60 mm
Length: 5 m | 16.4 ft
2 sleeves included

CODE
FA354522

COMPETITION NYLON THREAD 140



DESCRIPTION: Diameter: 1.40 mm
Length: 5 m | 16.4 ft
2 sleeves included

CODE
FA354525

SHOCK CORD W/ DYNEEMA



CODE
FA354603

SHOCK CORD W/ SNAP



CODE
FA354604

SHOCK CORD W/ PIGTAIL SWIVEL



CODE
FA354605

DRY GUN BAG



A beautiful bag for carrying the spearguns. It features an adjustable shoulder strap and a reinforced handle. It has YKK zip closing long 52.5 in | 133 cm. Inside there is a small pocket with velcro closure. On the top, you can roll and close firmly thanks to the adjustable buckles. Thanks to the special coating the bag

is waterproof and will protect the equipment inside. It is long approximately 70 in (179 cm), enough for carrying long spearguns or other equipment. It is an ideal bag for the spearfishing man that want to protect and easily transport his gear.

CODE	CASE PACK
UA926200	4

TECHNICAL FEATURES

- 840 Denier Nylon with waterproof coating
- YKK zip closing long 133 cm | 52.5 in
- **Dimensions:** 179 x 30.5 x 20 cm | 70 x 12 x 7.9 in
- Reinforced side handle and shoulder strap



NIKITA



Your speargun is a tool you use to bring home food. Like any tool, it needs to be cared for so it will perform to its best ability when needed. The Nikita Gun Bag for Pneumatic Spear Guns will give your speargun the protection it needs when in storage, being

transported, and keeps it out of the elements until needed to and from the dive site. Made from durable sewn fabric, drawstring closure equipped with barrel lock secures the gun in the bag when traveling or in storage.

CODE	SIZE	CASE PACK
UA926500	75 cm 29.5 in	5
UA926600	120 cm 47.2 in	5

TECHNICAL FEATURES

- Bag for carry and protect the Pneumatic guns
- Allows easy and safe transportation of gear
- Drawstring closure equipped with barrel lock
- Durable sewn fabric construction.
- **Two sizes available:** 75 cm | 29.5 in and 120 cm | 47.25 in

SAETTA PRO

| VACUUM-SEALED BARREL FOR MORE POWER



This speargun features a special offset-hermetically sealed muzzle- enabling the shaft to be loaded without flooding the interior of the barrel. In this manner, the piston does not have to expel the water from the interior and can apply the entire power of the gun onto the shaft. The result

is an extremely fast and precise shooting action, such as had never been realised on a pneumatic speargun. The grip handle set at a special angle facilitates aiming and control. It is soft and white coloured to facilitate locating the gun on the seafloor.

CODE	SIZE	CASE PACK
FS407000	70 cm	6
FS408800	88 cm	6
FS409910	110 cm	6

ACCESSORIES

CODE	PRODUCT
FA390001	MINI SPEAR HEAD
FA390004	MACH SPEAR HEAD 2-FLOPPER
FA390032	PRESSURE GAUGE for SAETTA
FZ370073	HAND PUMP for SAETTA/SAETTA P.R./SAETTA PRO
FA354523	SHAFT REFLOATER for PNEUMATIC GUNS

SPARE PARTS

CODE	PRODUCT	GUN LENGTH
FA372000	SHAFT 174PH Ø 7.5mm (77cm)	35 cm
FA373000	SHAFT 174PH Ø 7.5mm (95cm)	45 cm
FA376000	SHAFT 174PH Ø 7.5mm (117cm)	60 cm



TECHNICAL FEATURES

- Pneu-vacuum system: air-filled barrel
- Internal Ø 13 mm barrel
- Hermetically sealed muzzle
- Power reducer
- Safety lock
- Ergonomic handle
- Handle eyelet for cord connection
- Tahitian-style shaft Ø 7.5 mm made of 17-4 PH stainless steel

Ø 7.5 MM SHAFT WITH TOP FLOPPER



Ø 13 MM INTERNAL OFFSET BARREL

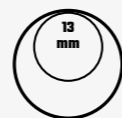

SLIDING PISTON AND TRIGGER HOOK



WITH POWER REDUCER



SEAL MUZZLE



OFFSET BARREL



THE LEGENDARY CRESSI HANDLE. THE ANGLE BETWEEN BARREL AND HANDLE DETERMINES THE WINNING ERGONOMICS OF CRESSI PNEUMATIC GUNS



SAETTA

| QUALITY & POWER



The Saetta black is the ultimate in pneumatic spearfishing. An upgraded model of the world-renowned Cressi SL series. The Saetta offers unmatched power, comfort and accuracy. A few design tweaks have been able to maximize shot power with high precision and speed. Among the upgrades of the extremely reliably SL series is a new muzzle with incorporated holes to aid in water drainage and a new, soft, angled white handle that also aids in locating the speargun underwater. The Saetta still boasts some of the same successful features of its

predecessors. For one, an anatomical high grip butt that enables the gun to be held in line with the arm. A strong line hook situated on the bottom of the grip butt for shaft loading. Also a safety catch that frees the line: releasing the device, when the trigger is pulled, and lastly, an Ø 8 mm threaded shaft. The Cressi Saetta is the new standard in pneumatic spearguns. The Saetta is available also with the version with the Power Reducer, a lever that reduces the power of the half, in case of close targets.



CODE	SIZE	STYLE	CASE PACK
FR384000	40 cm	No Power Reducer	6
FR385500	55 cm	No Power Reducer	6
FR387000	70 cm	No Power Reducer	6



CODE	SIZE	STYLE	CASE PACK
FS385500	55 cm	With Power Reducer	6
FS387000	70 cm	With Power Reducer	6
FS388800	88 cm	With Power Reducer	6
FS389910	110 cm	With Power Reducer	6

ACCESSORIES

CODE	PRODUCT
FA390001	MINI SPEAR HEAD
FA390004	MACH SPEAR HEAD 2-FLOPPER
FA390032	PRESSURE GAUGE for SAETTA
FZ370073	HAND PUMP for SAETTA/SAETTA P.R./SAETTA PRO
FA354523	SHAFT REFLOATER for PNEUMATIC GUNS

SPARE PARTS

CODE	PRODUCT	GUN LENGTH
FA360036	STAINLESS STEEL THREADED SHAFT Ø 8.0mm (36.5cm)	40 cm
FA361036	STAINLESS STEEL THREADED SHAFT Ø 8.0mm (55cm)	55 cm
FA362036	STAINLESS STEEL THREADED SHAFT Ø 8.0mm (68.5cm)	70 cm
FA363036	STAINLESS STEEL THREADED SHAFT Ø 8.0mm (87.5cm)	90 cm
FA365036	STAINLESS STEEL THREADED SHAFT Ø 8.0mm (99.5cm)	95 cm
FA366036	STAINLESS STEEL THREADED SHAFT Ø 8.0mm (109.5cm)	110 cm

TECHNICAL FEATURES

- Internal Ø 13 mm barrel
- Power reducer version available
- Safety lock
- Ergonomic handle
- Handle eyelet for cord connection
- Threaded shaft Ø 8.0 mm

Ø 8.0 MM THREADED SHAFT



Ø 13 MM INTERNAL OFFSET BARREL

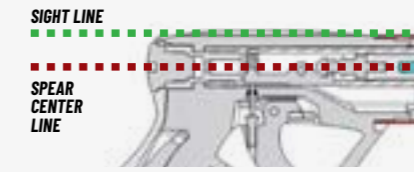
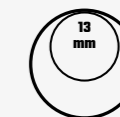

THE LEGENDARY CRESSI HANDLE. THE ANGLE BETWEEN BARREL AND HANDLE DETERMINES THE WINNING ERGONOMICS OF CRESSI PNEUMATIC GUNS



SL STAR

| THE HISTORY OF OUR PNEUMATIC GUNS



The SL Star range of pneumatic spear guns has been in production for many years now, and they have won worldwide fame for their excellence in terms of robustness, reliability, precision and powerful shooting. The various models correspond to the equivalent models in the SL series, without power reducer. Constantly updated over the years, the SL Star spear guns are ultra light, easy to use, and fire quickly. They come with anatomical

high grip butts enabling the gun to be held in line with the arm with no extra effort. The bright yellow butt means you can identify the gun even if it ends up on the sea-bottom after shooting. A strong line hook is situated on the bottom of the butt for shaft loading. The guns are fitted with a safety catch and, when the trigger is pulled, it frees the line releasing device. Stainless steel shafts are available separately.

CODE	SIZE	CASE PACK
FR374000	40 cm	6
FR375500	55 cm	6
FR377000	70 cm	6

ACCESSORIES

CODE	PRODUCT
FA390001	MINI SPEAR HEAD
FA390004	MACH SPEAR HEAD 2-FLOPPER
FA390020	PRESSURE GAUGE for SL/SL STAR
FA320060	HAND PUMP for SL SL STAR
FA354523	SHAFT REFLOATER for PNEUMATIC GUNS

SPARE PARTS

CODE	PRODUCT	GUN LENGTH
FA360036	STAINLESS STEEL THREADED SHAFT Ø 8.0mm (36.5cm)	35 cm
FA361036	STAINLESS STEEL THREADED SHAFT Ø 8.0mm (55cm)	45 cm
FA362036	STAINLESS STEEL THREADED SHAFT Ø 8.0mm (68.5cm)	60 cm



TECHNICAL FEATURES

- Ergonomic handle
- Shaft Ø 8.0 mm
- Safety lock
- Handle eyelet for cord connection

Ø 8.0 MM THREADED SHAFT



Ø 13 MM INTERNAL OFFSET BARREL



THE LEGENDARY CRESSI HANDLE. THE ANGLE BETWEEN BARREL AND HANDLE DETERMINES THE WINNING ERGONOMICS OF CRESSI PNEUMATIC GUNS



PNEUMATIC GUN SHAFTS

17-4 PH SHAFT Ø 7.5 mm

TOP FLOPPER



NEW 2022

DESCRIPTION:
These shafts offer exceptional durability due to the special steel construction.

CODE	GUN LENGTH
FA372000	35 cm
FA373000	45 cm
FA376000	60 cm

PR80 SHAFT Ø 8.0 mm

Ø 6 MM THREAD



DESCRIPTION:
For Cressi pneumatic spearguns, threaded to fit any Cressi threaded spear tip.

CODE	GUN LENGTH
FA360036	40 cm
FA361036	55 cm
FA362036	70 cm
FA363036	90 cm
FA366036	110 cm

INOX SHAFT Ø 8.0 mm

Ø 6 MM THREAD



DESCRIPTION:
Tempered steel shaft for Cressi pneumatic spearguns. Threaded to fit any Cressi threaded spear tip.

CODE	GUN LENGTH
FA360030	40 cm
FA360031	55 cm
FA360032	70 cm
FA360033	100 cm
FA360035	110 cm

SPEARHEADS

| FOR PNEUMATIC SPEARGUNS

MINI SPEAR HEAD

- * Stainless steel construction
- * Dual flopper design
- * Ø 6 mm internal thread



DESCRIPTION:
The Mini Spear Head is a dual flopper. Conical point. Threaded spear tip. Made with corrosion resistant Stainless Steel. The dual flopper setup tucks neatly against the relieved tip for the ultimate in penetration. Yet provides dual floppers for the ultimate in fish holding power. Threaded to fit Pneumatic shafts and threaded Euro shafts.

CODE	PRODUCT
FA390001	MINI SPEAR HEAD
FA390008	3 PRONGS SPEAR HEAD

MACH SPEAR HEAD

- * Stainless steel construction
- * Dual flopper design
- * Ø 6 mm internal thread



DESCRIPTION:
The Mach Spear Head is a dual flopper. Conical point. Threaded spear tip. The Stainless Steel dual flopper setup fold against the tip for the ultimate in penetration. Yet provides dual floppers for the ultimate in fish holding power. Threaded to fit Pneumatic shafts and threaded Euro shafts.

CODE	PRODUCT
FA390004	MACH SPEAR HEAD 2-FLOPPER

SHAFT REFLOATER



CODE
FA354523

SHAFT LOADER



CODE
FA390018

SPEARGUN OIL 100 ml



CODE
FA390022

PRESSURE GAUGE

I SL · SL STAR



CODE
FA390020

PRESSURE GAUGE

I SAETTA · SAETTA PRO



MADE IN ITALY



CODE
FA390032

HAND PUMP

I SL · SL STAR



MADE IN ITALY



CODE
FA320060

HAND PUMP

I SAETTA · SAETTA PRO



MADE IN ITALY



CODE
FZ370073



RUBBER SPEARGUN	GUN DETAILS										SHAFT DETAILS										POWER BAND DETAILS							
	OVERALL LENGTH cm - in	POWER LENGTH cm - in	BARREL Ø mm	SHOT RANGE m - ft	READY TO USE	SHOCK ABSORBER INCLUDED	MUZZLE TYPE	LINE LOOP	SHAFT CODE	MATERIAL	Ø mm	LENGTH cm	FLOPPER TYPE	TAB N°	TAB TYPE	REST TAB	POINT TYPE	COMPATIBLE SHAFTS Ø RANGE mm	COMPATIBLE SHAFTS LENGTHS RANGE cm	BAND CODE	N°	TYPE	MATERIAL	Ø mm	LENGTH mm	WISHBONE		
	CHEROKEE POWER 90																											
	CHEROKEE POWER 100																											
	CHEROKEE POWER 110																											
	CHEROKEE POWER 120																											
	CHEROKEE POWER 130																											
	CHEROKEE FAST 75																											
	CHEROKEE FAST 90																											
	CHEROKEE FAST 100																											
	CHEROKEE FAST 110																											
	CHEROKEE FAST 120																											
	CHEROKEE EXO 60																											
	CHEROKEE EXO 75																											
	CHEROKEE EXO 90																											
	CHEROKEE EXO 100																											
	CHEROKEE EXO 110																											
	COMANCHE RAIL 60																											
	COMANCHE RAIL 75																											
	COMANCHE RAIL 90																											
	COMANCHE RAIL 100																											
	COMANCHE RAIL 110																											
	YUMA FAST 60																											
	YUMA FAST 75																											
	YUMA FAST 90																											
	YUMA FAST 100																											
	APACHE 35																											
	APACHE 45																											
	APACHE 60																											
	APACHE 75																											
	APACHE 90																											

PNEUMATIC SPEARGUN	GUN DETAILS								EASIER LOADING PRESSURE			STANDARD PRESSURE		HARDER LOADING PRESSURE		SHAFT DETAILS				
	READY TO USE SET	SHOCK ABSORBER INCLUDED	SHOT RANGE m - ft	TOTAL LENGTH GUN + SPEAR cm	BARREL DIAMETER mm	LINE LOOP	BAR	PSI	BAR	PSI	BAR	PSI	MATERIAL	DIAMETER mm	LENGTH cm	FLOPPER TYPE	POINT TYPE	INCLUDED SHAFT SKU		
	SAETTA PRO W/REDUCER 70																			
	SAETTA PRO W/REDUCER 88																			
	SAETTA PRO W/REDUCER 110																			
	SAETTA 40																			
	SAETTA 55																			
	SAETTA 70																			
	SAETTA W/REDUCER 55																			
	SAETTA W/REDUCER 70																			
	SAETTA W/REDUCER 88																			
	SAETTA W/REDUCER 110																			
	SL STAR 40																			
	SL STAR 55																			
	SL STAR 70																			

FG1

| FIBERGLASS MONO-PIECE POLE SPEAR

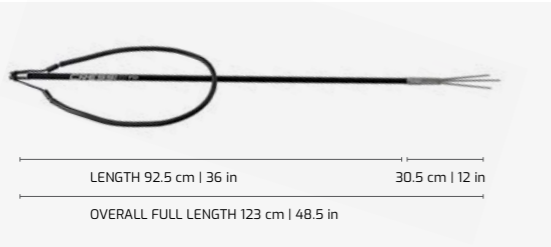
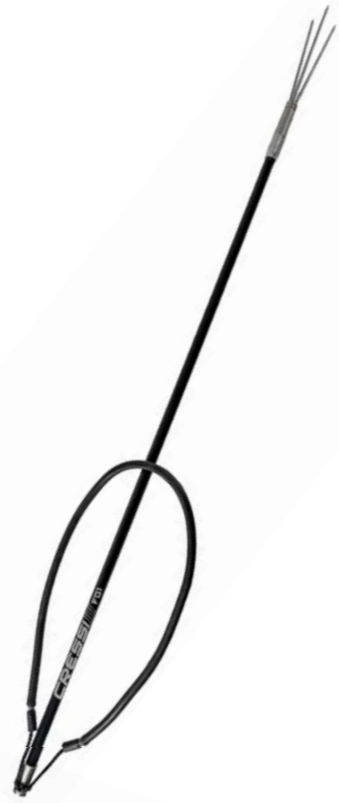

The FG1 is the ultimate pole spear made in fiberglass to ensure lightness and speed while underwater. Ideal for traveling and perfect for small to medium size fish. The top ends with a male fitting of 6 mm and two spanner flats that allow tightening using a wrench. It features an elastic rubber band made of OD latex tube with a cord inside installed to the hole. A Paralyzer Tip, composed of 3 tiny barb prongs is included.

CODE	CASE PACK
FP015001	5

TECHNICAL FEATURES

- Pole spear made in fiberglass for ensure lightness and speed while underwater.
- The bottom end is rounded with a hole for the rubber sling.
- The top ends with a male fitting of 6 mm and two spanner flats that allows tightening using a wrench.
- The rubber sling is made using a Ø 10 mm OD latex tube with cord inside, installed to the hole.
- Paralyzer tip composed of 3 tiny barb prongs, 25 cm | 10 in long, is included.

FG3

| FIBERGLASS 3-PIECE POLE SPEAR

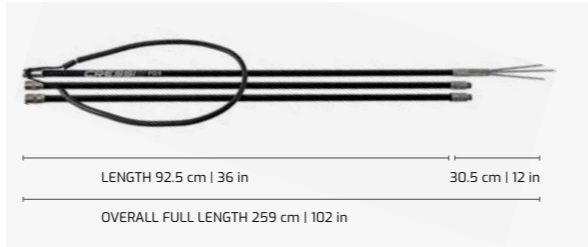
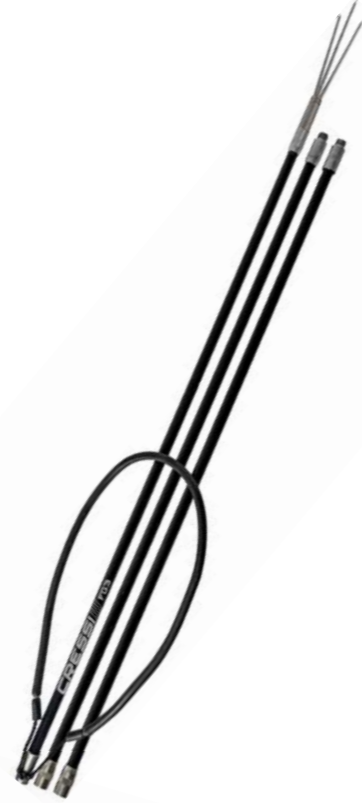

The FG3 is the ultimate pole spear made in fiberglass to ensure lightness and speed while underwater. Ideal for traveling and perfect for small to medium size fish. The top ends with a male fitting and two spanner flats that allow tightening using a wrench. It's composed of 3 pieces that can be assembled as desired. The threaded tip can accommodate different paralyzed tips.

CODE	CASE PACK
FP015003	5

ALUMINUM

| ALUMINUM 3-PIECE POLE SPEAR

- * **3 pieces:** 6.5 ft long for normal hunting conditions
- * **2 pieces:** 4.9 ft long for close range hunting and Lion Fish hunting
- * **1 piece:** 2.7 ft long strictly for Lion Fishes

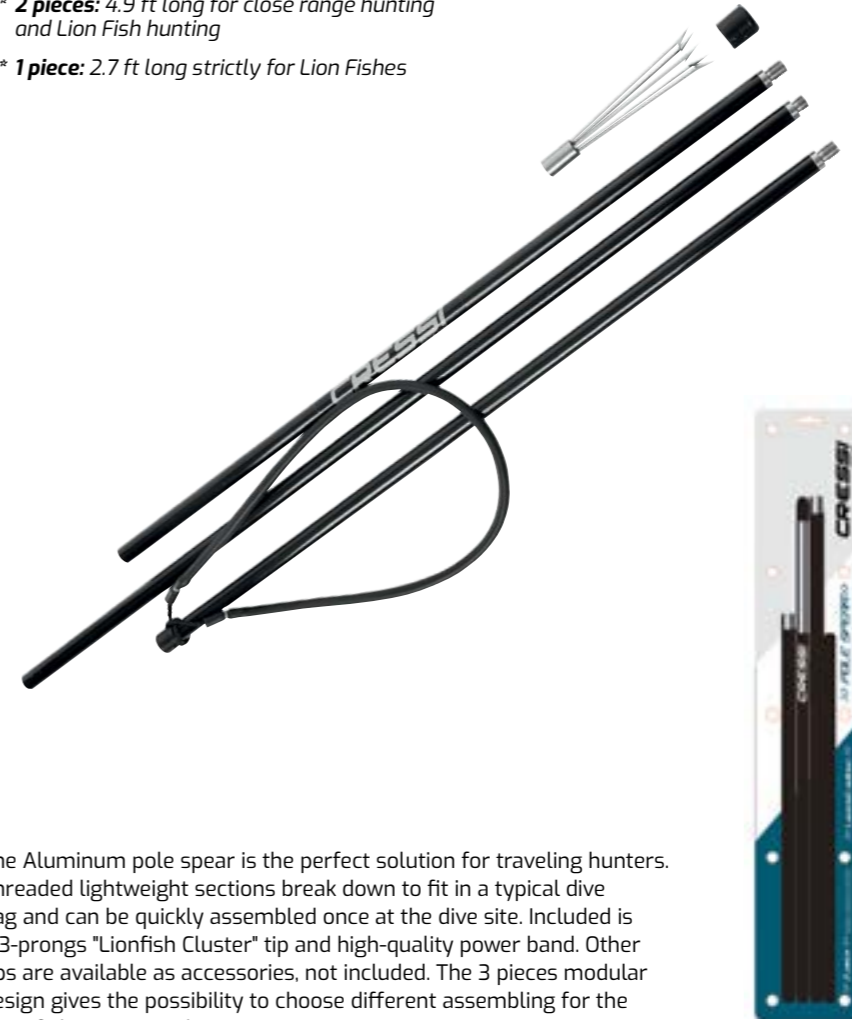

The Aluminum pole spear is the perfect solution for traveling hunters. Threaded lightweight sections break down to fit in a typical dive bag and can be quickly assembled once at the dive site. Included is a 3-prongs "Lionfish Cluster" tip and high-quality power band. Other tips are available as accessories, not included. The 3 pieces modular design gives the possibility to choose different assembling for the spearfisherman needs.

CODE	SIZE	STYLE	CASE PACK
USX040000	6.5 ft	3 pcs	5

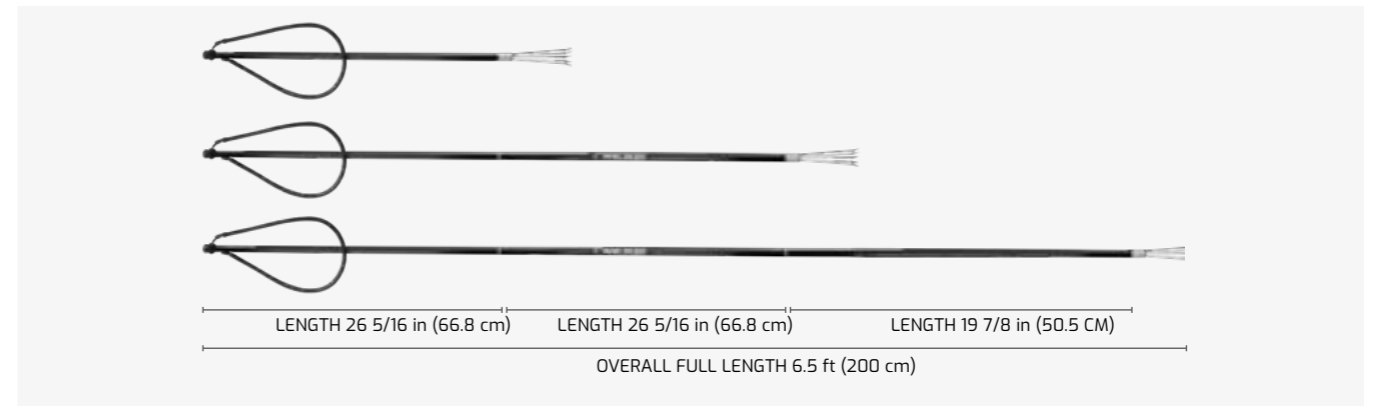

TECHNICAL FEATURES

- Thick-walled aluminum construction for durability
- Threaded joints join quickly and securely
- 3-prong lionfish paralyzer tip included

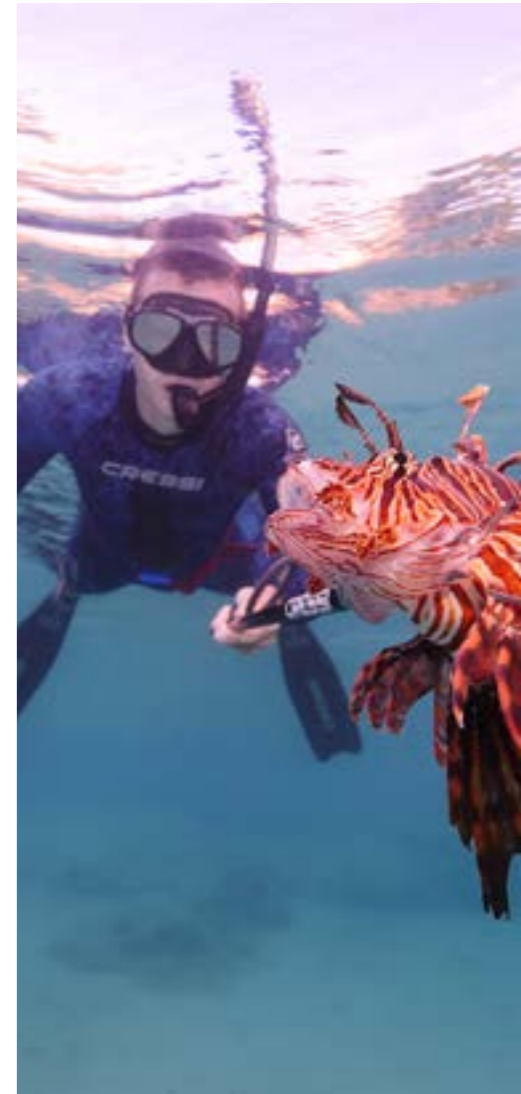

POLE SPEARS ACCESSORIES

3 BARBLESS PRONGS PARALYZER TIP



DESCRIPTION: 3 BARBLESS PRONGS
 Total length: 14 in - 35.5 cm
 Tip Ø: 5/8 in - 16 mm
 Thread Ø: 15/64 in - 6 mm

CODE
 USX020000

5 BARB PRONGS PARALYZER TIP



DESCRIPTION: 5 BARBLESS PRONGS
 Total length: 6 in - 15.2 cm
 Tip Ø: 5/8 in - 16 mm
 Thread Ø: 15/64 in - 6 mm

CODE
 FZ390006

POLE SPEAR POWER BAND

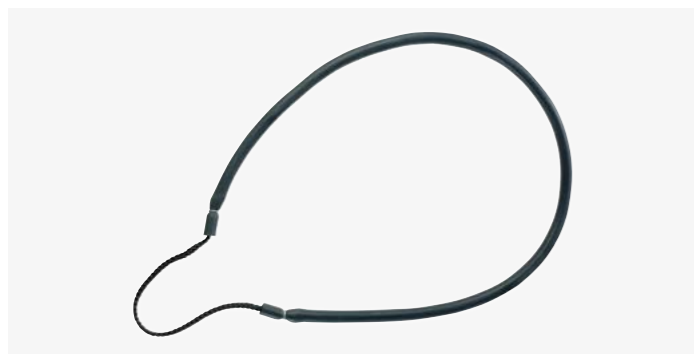

DESCRIPTION:
 Rubber length: 29 1/8 in - 74 cm
 Cord length: 8 5/8 in - 22 cm
 Total length: 37 6/8 in - 96 cm
 Rubber Ø: 3/8 in - 0.9 mm

CODE	SIZE	STYLE
FZ390007	75 cm	Ø 9 mm
FZ390008	115 cm	Ø 9 mm

TIP ADAPTOR 11 MM



DESCRIPTION:
 Inside Ø: 11 mm
 Outer Ø: 6 mm

CODE
 USX030000



WHITE COLOR TEMPERATURE | ADJUSTABLE ELASTIC STRAP | EXCELLENT ERGONOMICS | SWITCH WITH 3 POSITIONS | LED LIGHT TECHNOLOGY | PREMIUM MATERIALS | NARROWED LIGHT BEAM

LUMIA+ NEW 2022

ULTRA LED DIVE LAMP

Torch with a highly asymmetric design boasts excellent ergonomics and a highly tactile perception of its geometric characteristics. Thanks to this particular design, the switch position is immediately found without needing to use your eyesight. The porthole and body are coated with thermoplastic rubber to extend shelf life and reduce noises from impact when used for fishing. These ergonomic features are a big advantage over aluminium torches with a circular section which do not give feedback on the position of the grip and, in some cases, even require the use of two hands

to turn it on. The switch has three positions: Off, On Unstable with Automatic Return, On. The "On Unstable" position is particularly useful in fishing because it allows flashing by one simple press. The strap with slider spring allows adjustment according to the user's needs, but being elastic can be pulled out in case of emergency. Power is supplied by four AA batteries, either alkaline or rechargeable. The electronics ensure a constant level of brightness even when the batteries are rechargeable and/or not fully charged. Batteries included.

TECHNICAL FEATURES

- Luminous Flux: 300 Lumens
- Color Temperature: 6500 °K CRI>75
- Burn Time: 3.5 h
- Viewing Angle: 6°
- Illuminance: 30000 Lux
- Impact Resistance: 1.5 m
- Ingress Protection Code: PX-8 75m

NEW WHITE COLOR TEMPERATURE

The LED has a white color temperature similar to sunlight for maximum return of the colors in the underwater environment. The light beam of the LED is narrowed into a spot light beam of about 6° by means of a lens made of ultra-transparent material protected by the polycarbonate optical porthole.

ACTIVE ELECTRONICS

Power is supplied by four AA batteries, either alkaline or rechargeable. The power supply has an electronic management system that eliminates the gap between the different electrical potentials of different types of batteries and ensures an efficiency of 30% higher than the commonly used systems. The active electronics of the flashlight guarantee constant light, even when the battery charge decreases. When the charge drops below the safety threshold value, the lighting level will reduce to warn the user that the batteries are depleted.

Length	168 mm - 6.61 in
Head diameter	47 mm - 1.85 in
Weight	130 g - 4.58 oz (without batteries)

LUMIA + HIGH RANGE COLOR SPECTRUM



STANDARD LIGHT LIMITED RANGE COLOR SPECTRUM

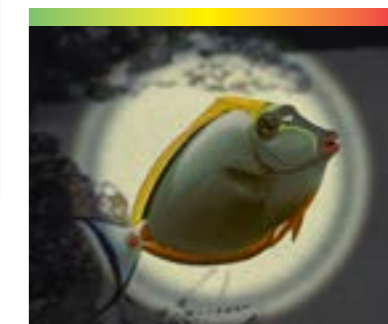

EXCELLENT ERGONOMICS

THANKS TO THERMOPLASTIC RUBBER COATING AND HIGHLY ASYMMETRIC DESIGN

SWITCH WITH 3 POSITIONS

ON | OFF | HOLDING ON WITH AUTOMATIC RETURN

NARROWED LIGHT BEAM

APPROXIMATELY 6° SPOT LIGHT BEAM THANKS TO TIR LENS

ADJUSTABLE ELASTIC STRAP

TO CUSTOMISE THE USE ACCORDING TO YOUR NEEDS

NEUTRAL WHITE COLOR TEMPERATURE

SIMILAR TO SUNLIGHT FOR MAXIMUM RETURN OF THE COLORS



BLACK/BLACK



BLACK/GREY



CODE	COLOR	CASE PACK
SJ550150	Black/Black	10
SJ550170	Black/Grey	10



LUMIA



87 WE
MANUFACTURE
QUALITY SINCE
1946



GRUPPO INDUSTRIALE
VALLEY SWEET
1974/85

Photo by Alberto Galbi



ORCA

| STAINLESS STEEL



This legendary product has been around for years and years and has now become a sought-after collector's item. It is considerably heavy and large, perfect for a work tool, which this knife is designed to be. The large blade is forged from special steel, with a smooth edge on one side and partly serrated on the other.

CODE	CASE PACK
RC556000	10

Blade length	17,8 cm - 7.0 in
Total length	30 cm - 11.8 in
Blade width	32 mm - 1.25 in
Blade thickness	5,5 mm - 0.22 in
Knife-only weight	450 g - 15.9 oz
Weight with sheath	600 g - 21.2 oz

SPARE PARTS

CODE	PRODUCT
RZ550003	SHEATH W/ STRAPS for ORCA
RZ551007	HOLDER for TOTEM/ORCA
RZ550018	STRAPS for KNIVES (PAIR)

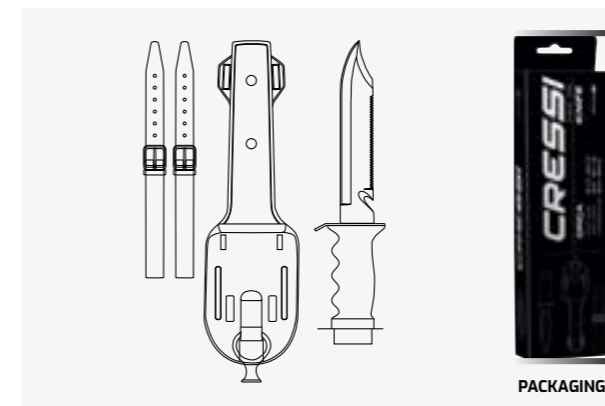

PACKAGING

GIANT

| STAINLESS STEEL 304



Knife having large dimensions that make it particularly effective during use. Perfect as a work tool or for particularly intensive use. Made of AISI 420 tempered steel and black coating.

CODE	CASE PACK
RC556500	10

Blade length	17,8 cm - 7.0 in
Total length	30,0 cm - 11.8 in
Blade width	29,7 mm - 1.1 in
Blade thickness	5,2 mm - 0.2 in
Knife-only weight	271 g - 9.6 oz
Weight with sheath	429 g - 15.1 oz

SPARE PARTS

CODE	PRODUCT
RZ550015	

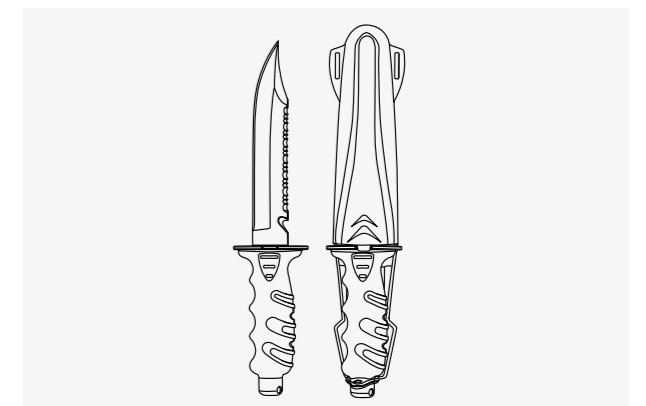

FINISHER

STAINLESS STEEL 304 + COATING



Medium-sized stiletto knife designed for underwater fishing. Manageable, high blade penetration and durability with a secure grip. The blade extends through the interior of the handle and, at the end of the handle, has a smallommel. Tempered AISI 304 steel with Black Coating. The duration of these features is guaranteed not by the sharpness itself, but by the quality of the material that guarantees the durability of the blade. Rhomboidal cross section for greater resistance to flexing and breaking. Double-edged blade with one smooth-edged side and the other serrated. Comfortable handle with rubbery polymer coating.

CODE	CASE PACK
RC559300	10

Blade length	12,7 cm - 5 in
Total length	24,7 cm - 9.7 in
Blade width	17 mm - 0.67 in
Blade thicknesses	3-5 mm - 0.1-0.2 in
Knife-only weight	130 g - 4.6 oz
Weight with sheath	200 g - 7.1 oz

SPARE PARTS

CODE	PRODUCT
RZ550016	SHEATH for FINISHER KNIFE
RZ550018	STRAPS for KNIVES (PAIR)

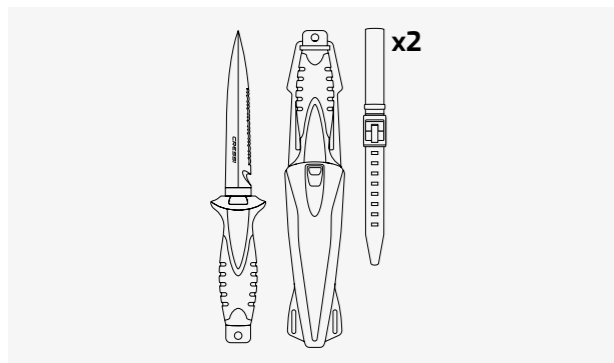

304 JAPANESE STEEL

BORG

STAINLESS STEEL



The Borg is a modern, large knife with a futuristic design and a strong, tempered blade. One side of the stainless steel blade is straight-edged, the other one is serrated right along the blade; they are both very sharp and effective for line cutting. The handle has an ergonomic design to ensure a secure grip even while wearing gloves. It is separated from the blade by a small techno-polymer thumb tab. The knife comes with a sheath that features a locking mechanism to allow one-hand release.

CODE	STYLE	CASE PACK
RC559100	Pointed Tip	10

Blade length	14,0 cm - 5.5 in
Total length	26,5 cm - 10.4 in
Blade width	25 mm - 1 in
Blade thicknesses	5 mm - 0.19 in
Knife-only weight	230 g - 8.1 oz
Weight with sheath	330 g - 11.6 oz

SPARE PARTS

CODE	PRODUCT
RZ550013	SHEATH for BORG KNIFE
RZ550018	STRAPS for KNIVES (PAIR)

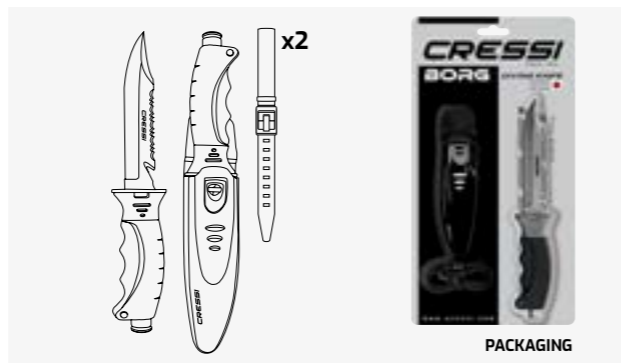

304 JAPANESE STEEL

BORG



The Borg is a modern, large knife with a futuristic design and a strong, tempered blade. One side of the stainless steel blade is straight-edged, the other one is serrated right along the blade; they are both very sharp and effective for line cutting. The handle has an ergonomic design to ensure a secure grip even while wearing gloves. It is separated from the blade by a small techno-polymer thumb tab. The knife comes with a sheath that features a locking mechanism to allow one-hand release.

CODE	STYLE	CASE PACK
RC559150	Blunt Tip	10

Blade length	13,0 cm - 5.0 in
Total length	25,5 cm - 10.0 in
Blade width	25 mm - 1 in
Blade thicknesses	5 mm - 0.19 in
Knife-only weight	230 g - 8.1 oz
Weight with sheath	330 g - 11.6 oz

SPARE PARTS

CODE	PRODUCT
RZ550013	SHEATH for BORG KNIFE
RZ550018	STRAPS for KNIVES (PAIR)

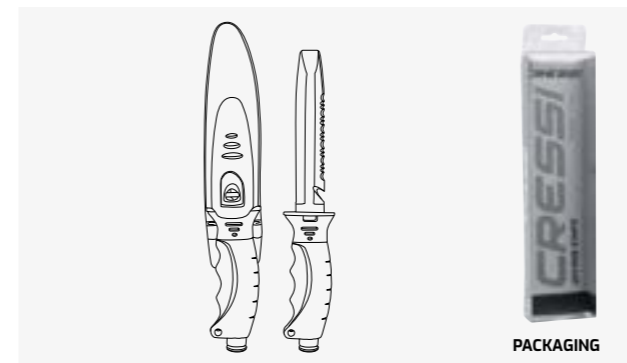

NORGE

NEW 2022

STAINLESS STEEL



Norge is a modern, compact knife with a futuristic design and a strong tempered blade. The anatomical, non-slip handle is made from soft grip material. It is separated from the blade by a small technopolymer thumb tab. The blade is made from special tempered stainless steel, with a smooth edge on one side and partly serrated on the other. This side of the blade has a line cutter at the handle end. The black technopolymer sheath comes with loops to attach it to leg or at the waist.

CODE	CASE PACK
RC553010	10

Blade length	11,7 cm - 4.6 in
Total length	22,8 cm - 9.0 in
Blade width	25 mm - 1 in
Blade thicknesses	4,5 mm - 0.18 in
Knife-only weight	140 g - 4.9 oz
Weight with sheath	250 g - 8.8 oz

SPARE PARTS

CODE	PRODUCT
RZ550005	SHEATH W/ STRAPS for NORGE



KAI

| STAINLESS STEEL W 1.4060 + COATING



Italian-made professional, multipurpose diver's knife, with blade and handle in w 1.14116 martensitic stainless steel, hardness HRC 55/56, for an extremely sharp and honed blade. The Idroglider Gold Black surface treatment increases resistance to corrosion in marine environments. It has a V-shaped cross section blade and is equipped with a saw, a line cutter, a bottle opener, a flat screwdriver and a loop for the leash. Available in two sizes, 23 cm and the 11 cm compact version, with a 1000 D ballistic nylon sheath.

CODE	CASE PACK
RC559510	10

Blade length	10 cm - 3.9 in
Total length	23 cm - 9 in
Blade width	30 mm - 1.2 in
Blade thickness	4 mm - 0.15 in
Knife-only weight	140 g - 4.9 oz
Weight with sheath	180 g - 6.3 oz

SPARE PARTS

CODE	PRODUCT
RZ559500	SHEATH NYLON for KAI

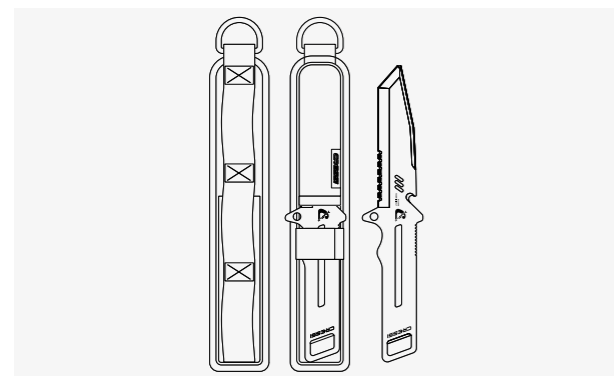

KAI MINI

| STAINLESS STEEL W 1.4060 + COATING



Italian-made professional, multipurpose diver's knife, with blade and handle in w 1.14116 martensitic stainless steel, hardness HRC 55/56, for an extremely sharp and honed blade. The Idroglider Gold Black surface treatment increases resistance to corrosion in marine environments. It has a V-shaped cross section blade and is equipped with a saw, a line cutter, a bottle opener, a flat screwdriver and a loop for the leash. Available in two sizes, 23 cm and the 11 cm compact version, with a 1000 D ballistic nylon sheath.

CODE	CASE PACK
RC559500	10

Blade length	4.5 cm - 1.77 in
Total length	11 cm - 4.33 in
Blade width	30 mm - 1.2 in
Blade thicknesses	4 mm - 0.15 in
Knife-only weight	65 g - 2.3 oz
Weight with sheath	90 g - 3.2 oz

SPARE PARTS

CODE	PRODUCT
RZ559510	SHEATH NYLON for KAI MINI

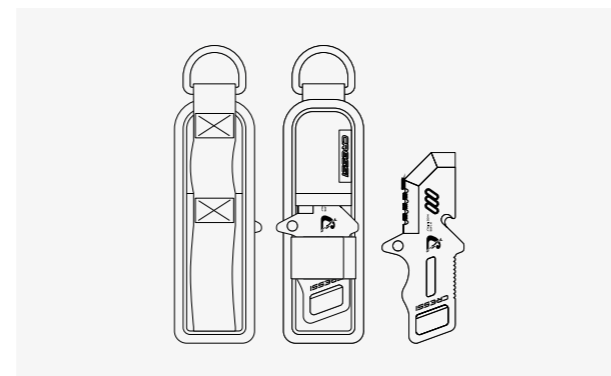

420 JAPANESE 420 STEEL



PREDATOR

NEW 2022

| STAINLESS STEEL 420 + COATING



Predator the evolution of the Killer model, designed to be the perfect finishing knife, very handy and anatomical. Its dimensions make it particularly suitable to be stored as a spare knife, or for divers who like to gear up in a practical and effective way.

CODE	CASE PACK
RC554500	10

Blade length	8,6 cm - 3.4 in
Total length	18,3 cm - 7.2 in
Blade width	17 mm - 0.67 in
Blade thicknesses	3-5 mm - 0.1-0.2 in
Knife-only weight	109 g - 3.8 oz
Weight with sheath	228 g - 8.0 oz

SPARE PARTS

CODE	PRODUCT
RZ550017	SHEATH for PREDATOR KNIFE
RZ550018	STRAPS for KNIVES (PAIR)

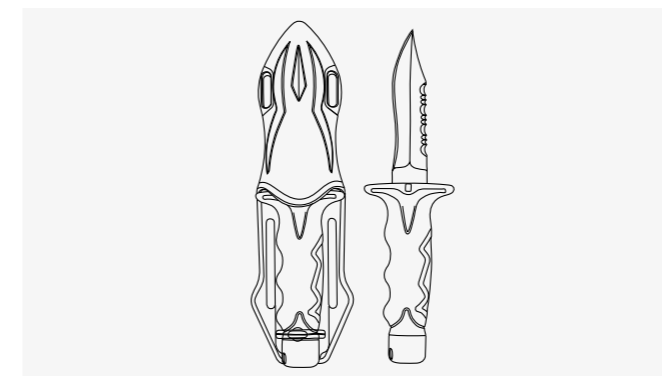

KILLER

| STAINLESS STEEL



A small knife that's been around for years now, highly appreciated because it is easy to handle and the blade penetrates really well. This is forged from a single piece of stainless steel, and is blocked at the grip by a screw knob situated at the end of the grip. One side of the blade has a smooth cutting edge, the other is partly serrated. The anatomical technopolymer grip ends at the blade with a thumb tab. The sheath is made from plastic and has a traditional elastic band to hold on the knife and loops to attach the knife to your leg or onto your belt.

CODE	CASE PACK
RC554000	10

Blade length	8,6 cm - 3.4 in
Total length	18 cm - 7.1 in
Blade width	25,2 mm - 1 in
Blade thicknesses	3-5 mm - 0.12-0.2 in
Knife-only weight	120 g - 4.2 oz
Weight with sheath	200 g - 7.1 oz

SPARE PARTS

CODE	PRODUCT
RZ550008	SHEATH W/ STRAPS for KILLER



PACKAGING



SUPERTOTEM

NEW 2022

| STAINLESS STEEL



An inexpensive, average-size knife with an excellent quality-price ratio. One side of the stainless steel blade is straight-edged, the other one is serrated right along the blade; they are both very sharp and effective for line cutting. The anatomic grip is made from technopolymers and has a series of moulds for the fingers, ending with a thumb protection tab at the blade end. The plastic sheath holds the knife firmly with a traditional elastic band and has loops to attach it to the leg or strap.

CODE	CASE PACK
RC550000	10

Blade length	12,4 cm - 4.9 in
Total length	23,2 cm - 9.1 in
Blade width	32 mm - 1.25 in
Blade thickness	3 mm - 0.12 in
Knife-only weight	120 g - 4.2 oz
Weight with sheath	210 g - 7.4 oz

SPARE PARTS

CODE	PRODUCT
RZ550004	SHEATH W/ STRAPS for SUPERTOTEM
RZ550018	STRAPS for KNIVES (PAIR)

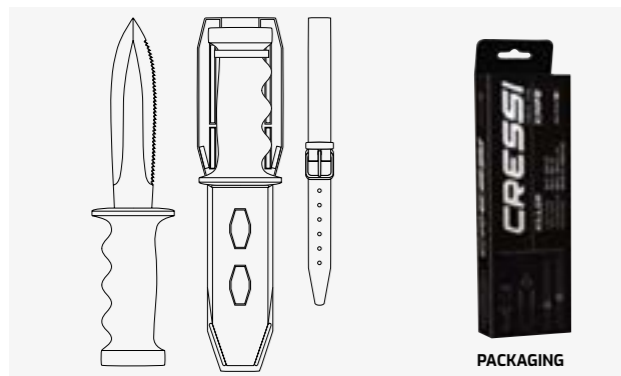

PACKAGING

GRIP

| SPEAR TITANIUM



* Hose attachment included
* BC mount straps included

The Grip Titanium is a small-sized knife with a titanium blade that lasts longer and is easy to use. It's rust-resistant and features a high-precision sharpened tip. One side is an extra-rigid serrated blade for sawing; the other side is a skillfully crafted straight blade. It features an ergonomic non-slip handle grip and a hole to add a lanyard (not included).

CODE	CASE PACK
RC559420	5

Blade length	7,4 cm - 2.9 in
Total length	17,4 cm - 6.8 in
Knife-only weight	35,4 g - 1.2 oz
Weight with sheath	80,7 g - 2.8 oz

SPARE PARTS

CODE	PRODUCT
RZ550022	SHEATH FOR GRIP TITANIUM

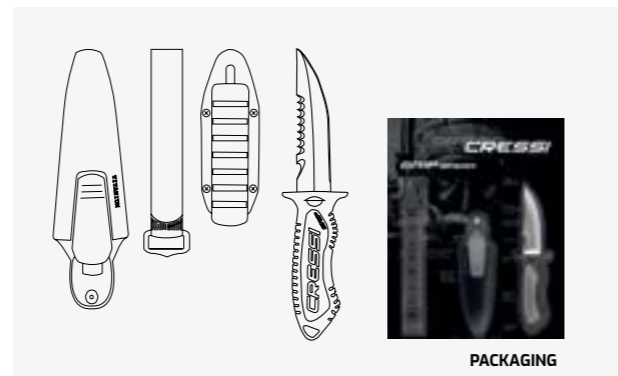

PACKAGING

420 JAPANESE
420 STEEL

GRIP

| SPEAR BLACK



The Grip Spear Black is a small-sized knife with a special blade with two edges; ideal for any dives. The blade is made with the Japanese 420 Stainless Steel: strong and rust resistant. It features a high precision Dagger point tip. One side is an extra rigid serrated blade for sawing, the other side is a skillfully crafted straight blade. It features an ergonomic non-slip handle grip and a hole to add a lanyard (not included). The knife comes with a sheath that can be attached at the BCD shoulder strap. It has a Lock Mechanism that secures the knife. With 2 rubber straps (included) you can fix the sheath at your leg or at you arm.

CODE	CASE PACK
RC559430	5

Blade length	7,6 cm - 3.0 in
Total length	17,4 cm - 6.8 in
Knife-only weight	51 g - 1.8 oz
Weight with sheath	88 g - 3.1 oz

SPARE PARTS

CODE	PRODUCT
RZ550021	SHEATH FOR GRIP SPEAR

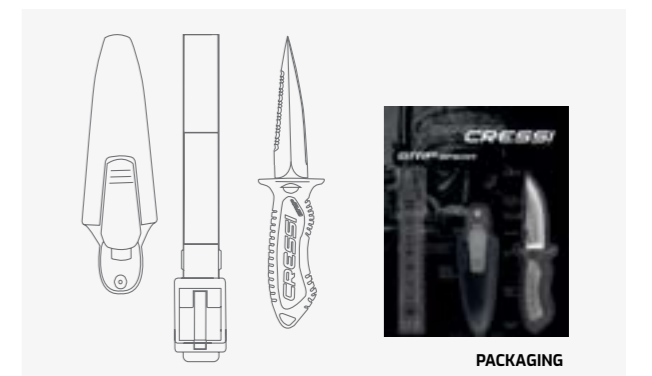

PACKAGING

GRIP

| SPEAR



The Grip Spear is a small-sized knife with a tapered blade that makes it ideal for spearfishing. The blade is made of stainless steel. It features a high-precision dagger point tip. One side is an extra-rigid serrated blade for sawing, the other side is a skillfully crafted straight blade. It features an ergonomic non-slip handle grip and a hole to add a lanyard (not included). The knife comes with a sheath that can be attached to the BCD shoulder strap.

CODE	CASE PACK
RC559400	5

Blade length	8,1 cm - 3.1 in
Total length	17,4 cm - 6.8 in
Knife-only weight	49 g - 1.7 oz
Weight with sheath	85 g - 3.0 oz

SPARE PARTS

CODE	PRODUCT
RZ550021	SHEATH FOR GRIP SPEAR

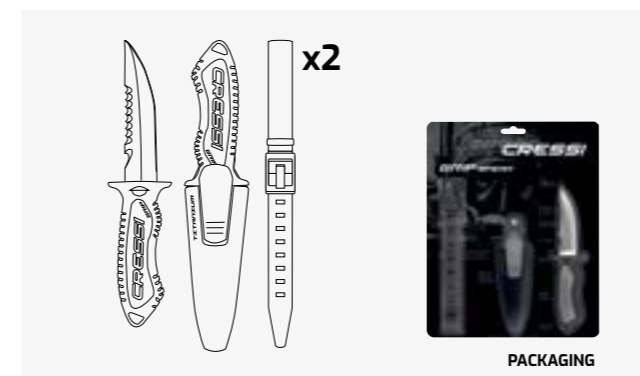

PACKAGING

SKORPION

| STAINLESS STEEL



Skorpion is a modern knife of last generation design and of medium dimensions, with a resistant tempered blade of tempered AISI 304 steel, with a smooth edge and a serrated edge with a wire cutter incorporated. The handle is anatomically shaped and made of "soft grip" material for a secure grip. It is separated from the blade by an integrated handguard made of technopolymer. Includes a pot in the same material as the leaf. The cover is made of black technopolymer and has straps for fixing to the thigh or belt. The knife comes with a sheath that features a locking mechanism to allow one-hand release. The sheath comes with two, standard issue straps to attach it to your leg.

CODE	STYLE
RC559000	Steel Blade
XRC569050	Black Blade

Blade length	11 cm - 4.3 in
Total length	23,2 cm - 9.1 in
Blade width	25,5 mm - 1 in
Blade thickness	5 mm - 0.18 in
Knife-only weight	200 g - 7.1 oz
Weight with sheath	280 g - 9.9 oz

SPARE PARTS

CODE	PRODUCT
RZ550014	SHEATH for SKORPION KNIFE
RZ550018	STRAPS for KNIVES (PAIR)

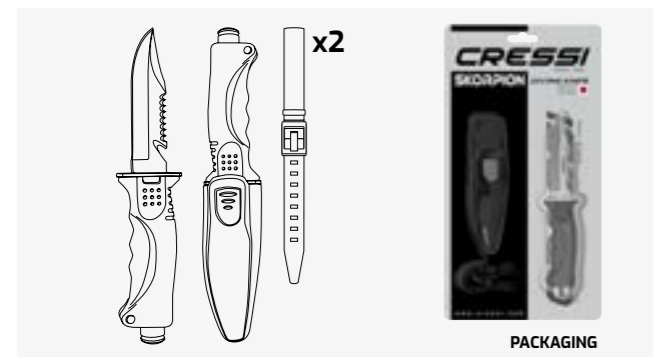

VIGO

STAINLESS STEEL



Versatile knife featuring a blade made from stainless steel specifically made for the marine environment. Sheath with locking mechanism to allow one-hand release. The knife comes with two, standard issue straps to attach it to your leg.

CODE	CASE PACK
RC555000	10

Blade length	11,8 cm - 4.6 in
Total length	23,5 cm - 9.2 in
Blade width	25,2 mm - 1 in
Blade thickness	5 mm - 0.19 in
Knife-only weight	147 g - 5.2 oz
Weight with sheath	217 g - 7.6 oz



KNIVES SPARE PARTS

CODE	PRODUCT
RZ550003	SHEATH W/ STRAPS for ORCA
RZ550004	SHEATH W/ STRAPS for SUPERTOTEM
RZ550010	SHEATH for LAMA ARA KNIFE
RZ550012	SHEATH for LIMA KNIFE
RZ550013	SHEATH for BORG KNIFE
RZ550014	SHEATH for SKORPION KNIFE
RZ550015	SHEATH for GIANT KNIFE
RZ550016	SHEATH for FINISHER KNIFE
RZ550017	SHEATH for PREDATOR KNIFE
RZ550018	STRAPS for KNIVES (PAIR)
RZ550019	SHEATH FOR ALLIGATOR
RZ550020	SHEATH FOR GRIP BLUNT
RZ550021	SHEATH FOR GRIP SPEAR
RZ550022	SHEATH FOR GRIP TITANIUM
RZ551007	HOLDER for TOTEM/ORCA
RZ559500	SHEATH NYLON for KAI
RZ559510	SHEATH NYLON for KAI MINI

KNIVES COMPARISON CHART

PRODUCT	BLADE LENGTH	TOTAL LENGTH	BLADE WIDTH	BLADE THICKNESS	KNIFE-ONLY WEIGHT	WEIGHT WITH SHEATH
ORCA	17,8 cm 7.0 in	30 cm 11.82 in	32 mm 1.25 in	5,5 mm 0.22 in	450 g 15.9 oz	600 g 21.2 oz
GIANT	17,8 cm 7.0 in	30,0 cm 11.8 in	29,7 mm 1.1 in	5,2 mm 0.2 in	271 g 9.6 oz	429 g 15.1 oz
FINISHER	12,7 cm 5.0 in	24,7 cm 9.7 in	17 mm 0.67 in	3-5 mm 0.1-0.2 in	130 g 4.6 oz	200 g 7.1 oz
BORG POINTED TIP	14,0 cm 5.5 in	26,5 cm 10.4 in	25 mm 1 in	5 mm 0.19 in	230 g 8.1 oz	330 g 11.6 oz
BORG BLUNT TIP	13,0 cm 5.0 in	25,5 cm 5.0 in	25 mm 1 in	5 mm 0.19 in	230 g 8.1 oz	330 g 11.6 oz
NORGE	11,7 cm 4.6 in	22,8 cm 9.0 in	25 mm 1 in	4,5 mm 0.18 in	140 g 4.9 oz	250 g 8.8 oz
KAI	10 cm 3.9 in	23 cm 9 in	30 mm 1.2 in	4 mm 0.15 in	140 g 4.9 oz	180 g 6.3 oz
KAI MINI	4,5 cm 1.77 in	11 cm 4.33 in	30 mm 1.2 in	4 mm 0.15 in	65 g 2.3 oz	90 g 3.2 oz
PREDATOR	8,6 cm 3.4 in	18,3 cm 7.2 in	17 mm 0.67 in	3-5 mm 0.1-0.2 in	109 g 3.8 oz	228 g 8.0 oz
KILLER	8,6 cm 3.4 in	18 cm 7.1 in	25,2 mm 1 in	3-5 mm 0.1-0.2 in	120 g 4.2 oz	200 g 7.1 oz
SUPERTOTEM	12,4 cm 4.9 in	23,2 cm 9.1 in	32 mm 1.25 in	3 mm 0.12 in	120 g 4.2 oz	210 g 7.4 oz
GRIP POINT TIP	8,1 cm 3.1 in	17,4 cm 6.8 in	n/a	n/a	49 g 1.7 oz	85 g 3.0 oz
SKORPION	11 cm 4.3 in	23,2 cm 9.1 in	25,5 mm 1 in	5 mm 0.18 in	200 g 7.1 oz	280 g 9.9 oz
VIGO	11,8 cm 4.6 in	23,5 cm 9.2 in	25,2 mm 1 in	5 mm 0.19 in	147 g 5.2 oz	217 g 7.6 oz



BRAND SUPPORT

35WE
MANUFACTURE
QUALITY SINCE
1946

FULL FACE MASK

| METAL SLATWALL DISPLAY



CODE
VAEDUKE

MASK

| ACRYLIC SLATWALL DISPLAY



CODE
VAEMASK

SNORKEL

| ACRYLIC SLATWALL DISPLAY



CODE
VAESNOR

FLAT

| ACRYLIC SLATWALL DISPLAY



CODE
VAEFLAT

WRIST COMPUTER DISPLAY

| ACRYLIC TABLE TOP DISPLAY



CODE
VAEUATT

WRIST COMPUTER DISPLAY

| METAL SLATWALL DISPLAY



CODE
VAEUMWC

REGULATOR DISPLAY

| METAL SLATWALL DISPLAY



CODE
VAEUMWR

CONSOLE DISPLAY

| METAL SLATWALL DISPLAY



CODE
VAEUMWD

HOOK FOR WETSUITS



CODE
VAEWETSUIT

HOOK FOR FINS



CODE
VAEFINS

SLATWALL METAL FACEOUT



CODE
VAEWAGF

MOBILE METAL STAND DISPLAY



CODE
VAEMOMS

BLUE FLAG



70 x 45 cm | 27.6 x 17.7 in

30 x 20 cm | 11.8 x 7.9 in

CODE	COLOR	SIZE
VABANB05	Blue	70 x 45 cm 27.6 x 17.7 in
VABANB06	Blue	30 x 20 cm 11.8 x 7.9 in

DIVE CENTER FLAG



100 x 70 cm | 39.4 x 27.6 in

70 x 45 cm | 27.6 x 17.7 in

30 x 20 cm | 11.8 x 7.9 in

CODE	COLOR	SIZE
VABANB11	White	100 x 70 cm 39.4 x 27.6 in
VABANB15	White	70 x 45 cm 27.6 x 17.7 in
VABANB16	White	30 x 20 cm 11.8 x 7.9 in

FEATHER



CODE
VABANOUT

STICKERS

CRESSI SINCE 1946

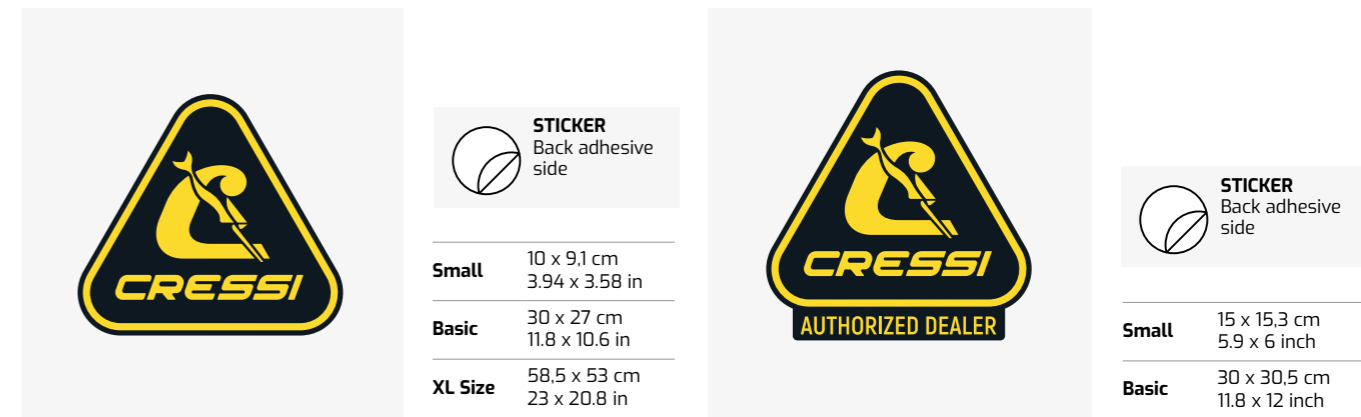

CODE
VPADE5210
VPADE5010
VPADE5110

CODE
VPADE5211
VPADE5011

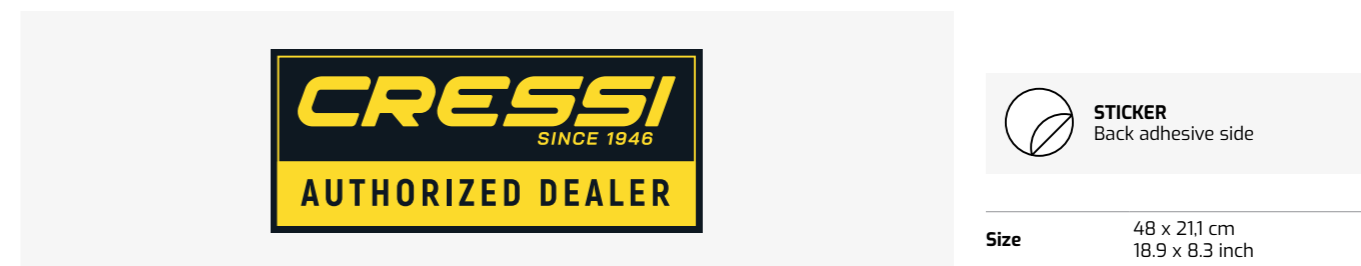

CODE
VPADE5012

Size
48 x 21.1 cm
18.9 x 8.3 inch



Photo by Jason Washington

SPARE PARTS



MANUFACTURE
QUALITY SINCE
1973

MASK

| OPTICAL LENSES

Please also refer to the Cressi Spare Parts Catalog for further information and Technical Details

» The Optical Lens are sold individually. The Focus lenses can be mounted both for left and right.

CODE	PRODUCT
D1240010	Optical Lens -1.0 For Focus Mask
D1240015	Optical Lens -1.5 For Focus Mask
D1240020	Optical Lens -2.0 For Focus Mask
D1240025	Optical Lens -2.5 For Focus Mask
D1240030	Optical Lens -3.0 For Focus Mask
D1240035	Optical Lens -3.5 For Focus Mask
D1240040	Optical Lens -4.0 For Focus Mask
D1240045	Optical Lens -4.5 For Focus Mask
D1240050	Optical Lens -5.0 For Focus Mask
D1240055	Optical Lens -5.5 For Focus Mask
D1240060	Optical Lens -6.0 For Focus Mask
D1240065	Optical Lens -6.5 For Focus Mask
D1240070	Optical Lens -7.0 For Focus Mask
D1240075	Optical Lens -7.5 For Focus Mask
D1240080	Optical Lens -8.0 For Focus Mask

MASK

| OPTICAL LENSES

Please also refer to the Cressi Spare Parts Catalog for further information and Technical Details

CODE	PRODUCT
D1336010	Optical Lens - 1.0 (Right) For Big Eyes Evolution Mask
D1336015	Optical Lens - 1.5 (Right) For Big Eyes Evolution Mask
D1336020	Optical Lens - 2.0 (Right) For Big Eyes Evolution Mask
D1336025	Optical Lens - 2.5 (Right) For Big Eyes Evolution Mask
D1336030	Optical Lens - 3.0 (Right) For Big Eyes Evolution Mask
D1336035	Optical Lens - 3.5 (Right) For Big Eyes Evolution Mask
D1336040	Optical Lens - 4.0 (Right) For Big Eyes Evolution Mask
D1336045	Optical Lens - 4.5 (Right) For Big Eyes Evolution Mask
D1336050	Optical Lens - 5.0 (Right) For Big Eyes Evolution Mask
D1336055	Optical Lens - 5.5 (Right) For Big Eyes Evolution Mask
D1336060	Optical Lens - 6.0 (Right) For Big Eyes Evolution Mask
D1336110	Optical Lens - 1.0 (Left) For Big Eyes Evolution Mask
D1336115	Optical Lens - 1.5 (Left) For Big Eyes Evolution Mask
D1336120	Optical Lens - 2.0 (Left) For Big Eyes Evolution Mask
D1336125	Optical Lens - 2.5 (Left) For Big Eyes Evolution Mask
D1336130	Optical Lens - 3.0 (Left) For Big Eyes Evolution Mask
D1336135	Optical Lens - 3.5 (Left) For Big Eyes Evolution Mask
D1336140	Optical Lens - 4.0 (Left) For Big Eyes Evolution Mask
D1336145	Optical Lens - 4.5 (Left) For Big Eyes Evolution Mask
D1336150	Optical Lens - 5.0 (Left) For Big Eyes Evolution Mask
D1336155	Optical Lens - 5.5 (Left) For Big Eyes Evolution Mask
D1336160	Optical Lens - 6.0 (Left) For Big Eyes Evolution Mask
D1260010	Optical Lens -1.0 (Right) For Big Eyes Mask
D1260015	Optical Lens -1.5 (Right) For Big Eyes Mask
D1260020	Optical Lens -2.0 (Right) For Big Eyes Mask
D1260025	Optical Lens -2.5 (Right) For Big Eyes Mask
D1260030	Optical Lens -3.0 (Right) For Big Eyes Mask
D1260035	Optical Lens -3.5 (Right) For Big Eyes Mask
D1260040	Optical Lens -4.0 (Right) For Big Eyes Mask
D1260045	Optical Lens -4.5 (Right) For Big Eyes Mask
D1260050	Optical Lens -5.0 (Right) For Big Eyes Mask
D1260055	Optical Lens -5.5 (Right) For Big Eyes Mask
D1260060	Optical Lens -6.0 (Right) For Big Eyes Mask
D1260110	Optical Lens -1.0 (Left) For Big Eyes Mask
D1260115	Optical Lens -1.5 (Left) For Big Eyes Mask
D1260120	Optical Lens -2.0 (Left) For Big Eyes Mask
D1260125	Optical Lens -2.5 (Left) For Big Eyes Mask
D1260130	Optical Lens -3.0 (Left) For Big Eyes Mask
D1260135	Optical Lens -3.5 (Left) For Big Eyes Mask
D1260140	Optical Lens -4.0 (Left) For Big Eyes Mask
D1260145	Optical Lens -4.5 (Left) For Big Eyes Mask
D1260150	Optical Lens -5.0 (Left) For Big Eyes Mask
D1260155	Optical Lens -5.5 (Left) For Big Eyes Mask
D1260160	Optical Lens -6.0 (Left) For Big Eyes Mask

DIMENSION CHART

BAGS DIMENSION CHART

	DIMENSION (LENGTH-WIDTH-HEIGHT)		VOLUME		WEIGHT	
	CENTIMETER	INCH	LITER	CU FT	KG	LB
JUMBO	50 x 35 x 80 h	19 3/4 x 13 3/4 x 31 1/2	140	4.90	4.5 kg	9 lb 15 oz
MOBY 5	40 x 28 x 76 h	15 1/2 x 11 x 30 h	115	4.06	3.9 kg	8 lb 10 oz
MOBY 5 HYDRO	40 x 28 x 76 h	15 1/2 x 11 x 30 h	115	4.06	5.1 kg	11 lb 4 oz
GORILLA PRO XL	95 x 34 x 42 h	37 x 13 x 16 h	135	4.77	1.5 kg	3 lb 5 oz
TUNA	95 x 40 x 41 h	37 1/2 x 15 3/4 x 16 1/8 h	120	4.23	3.5 kg	7 lb 11 oz
GORGONA	ø 38 x 96 h	ø 15 x 37 3/8 h	107	3.78	750 g	1 lb 10 oz
ROATAN	ø 39.5 - 72 h	15 ø - 28 h	90	3.18	1.2 kg	2 lb 10 oz
UTILA	ø 38.5 - 70 h	15 ø - 27 h	85	3.00	1.1 kg	2 lb 7 oz
CRETE	ø 37 x 60 h	ø 14 5/8 x 23 5/8 h	64.5	2.28	580 g	1 lb 4 oz
PIPER	35.5 x 23 x 56 h	14 x 9 x 22 h	49	1.73	2.9 kg	6 lb 6 oz
DRY GARA BACKCASE PACK	39.5 x 23.5 x 66 h	15 x 9 x 26 h	60	2.12	1.12 kg	2 lb 7.5 oz
PIOVRA	30 x 30 x 102 h	11 3/4 x 11 3/4 x 40 1/8 h	70	2.47	1.5 kg	3 lb 5 oz
PIOVRA XL	30 x 30 x 130 h	11 3/4 x 11 3/4 x 44 h	85	3.00	1.6 kg	3 lb 8 oz
OCTOPUS	ø 23 x 54 h	ø 9 x 21 1/2 h	30	1.06	660 g	1 lb 7 oz
DRY BAG 20 L	ø 23 x 43 h	ø 9 x 17 h	20	0.71	480 g	16.9 oz
DRY BAG 15 L	ø 23 x 34 h	ø 9 x 13 1/2 h	15	0.53	350 g	12.3 oz
DRY BAG 10 L	ø 19 x 36 h	ø 7 1/2 x 14 1/8 h	10	0.35	320 g	11.3 oz
DRY BAG 5 L	ø 19 x 28 h	ø 7 1/2 x 11 h	5	0.18	255 g	9 oz

MEN'S LONG WETSUITS DIMENSION CHART



SIZE	WEIGHT		A - HEIGHT		B - CHEST		C - WAIST		D - HIP		
	US/EU	KG	LB	CM	IN	CM	IN	CM	IN	CM	IN
XS: 36/46		50-58	110-128	156-165	61-65	70-75	28-30	59-65	23-26	72-77	28-30
S: 38/48		60-68	132-150	164-173	65-68	78-83	31-33	65-71	25-28	78-83	31-33
M: 40/50		70-78	154-172	169-178	67-70	86-91	34-36	71-77	28-30	84-89	33-35
L: 42/52		80-88	176-194	174-183	69-72	94-99	37-39	77-83	30-33	90-95	35/37
XL: 44/54		90-98	198-216	179-188	71-74	102-107	40-42	83-89	33-35	96-101	38-40
2XL: 46/56		100-108	220-238	184-193	72-76	110-115	43-45	89-95	35-37	102-107	40-42
3XL: 48/58		105-115	231-254	191-198	75-78	118-123	46-48	95-101	37-40	108-113	43-45

WOMEN'S LONG WETSUITS DIMENSION CHART



SIZE	WEIGHT		A - HEIGHT		B - CHEST		C - WAIST		D - HIP		
	US/EU	KG	LB	CM	IN	CM	IN	CM	IN	CM	IN
XS: 8/42		47-52	104-115	160-165	63-65	77-82	30-32	56-61	22-24	83-87	32-34
S: 10/44		53-58	117-128	165-170	65-67	82-87	32-34	60-65	24-26	87-91	34-36
M: 12/46		59-64	130-141	170-175	67-69	87-92	34-36	64-69	25-27	91-95	36-37
L: 14/48		64-70	141-154	175-180	69-71	92-97	36-38	68-73	27-29	95-99	37-39
XL: 16/50		70-80	154-176	180-185	71-73	97-102	38-40	72-77	28-30	99-103	39-41
2XL: 18/52		80-90	176-198	185-190	73-75	102-107	40-42	76-81	30-32	103-107	40.5-42

TROPICAL GLOVES 2MM

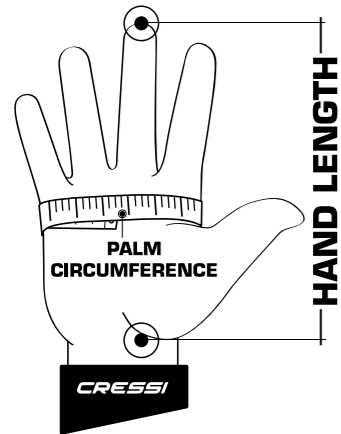

PALM CIRCUMFERENCE:
Measured at area shown
(use soft measuring tape)

HAND LENGTH:
Measure from the wrist crease
to the tip of the middle finger

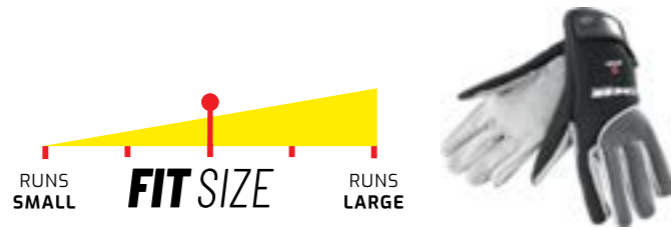

SIZE CHART		
SIZE	PALM CIRCUMFERENCE	HAND LENGTH
S	7.5 - 8 in (19 cm - 20.3 cm)	7 - 7.5 in (17.7 cm - 19 cm)
M	8 - 8.5 in (20.3 cm - 21.5 cm)	7.5 - 8 in (19 cm - 20.5 cm)
L	8.5 - 9 in (21.5 cm - 22.8 cm)	8 - 8.5 in (20.5 cm - 21.5 cm)
XL	9 - 9.5 in (22.9 cm - 24.1 cm)	8.5 - 9 in (21.5 cm - 22.8 cm)
2XL	9.5 - 10 in (24.1 cm - 25.4 cm)	9 - 9.5 in (22.9 cm - 24.1 cm)

CRESSI'S SIZE CHART IS TO BE USED AS A REFERENCE ONLY

HIGH STRETCH GLOVES

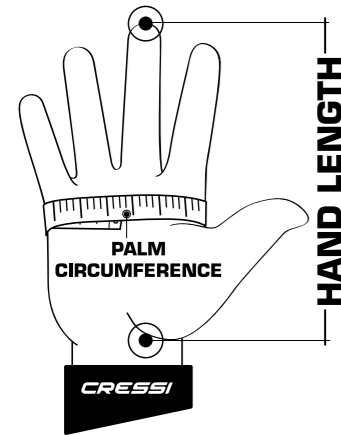

PALM CIRCUMFERENCE:
Measured at area shown
(use soft measuring tape)

HAND LENGTH:
Measure from the wrist crease
to the tip of the middle finger

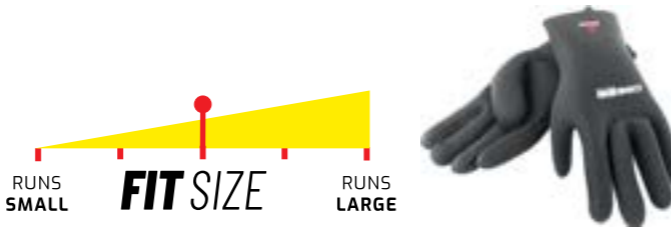

SIZE CHART		
SIZE	PALM CIRCUMFERENCE	HAND LENGTH
S	7.5 - 8 in (19 cm - 20.3 cm)	7 - 7.5 in (17.7 cm - 19 cm)
M	8 - 8.5 in (20.3 cm - 21.5 cm)	7.5 - 8 in (19 cm - 20.5 cm)
L	8.5 - 9 in (21.5 cm - 22.8 cm)	8 - 8.5 in (20.5 cm - 21.5 cm)
XL	9.5 - 10.5 in (24 cm - 26 cm)	8.5 - 9 in (21.5 cm - 22.8 cm)

CRESSI'S SIZE CHART IS TO BE USED AS A REFERENCE ONLY

HOODS

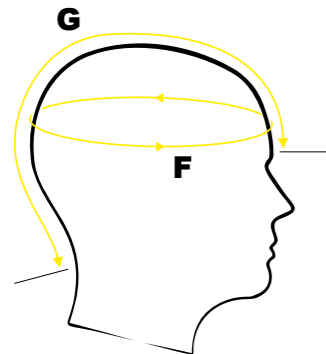

WOMEN'S SIZE CHART			MEN'S SIZE CHART		
SIZE	F HEAD CIRCUMFERENCE	G HEAD LENGTH	SIZE	F HEAD CIRCUMFERENCE	G HEAD LENGTH
XS	19.7 - 21.3 in (50-54 cm)	17.7 - 18.1 in (45-46 cm)	S	20.9 - 22 in (53-56 cm)	17.7 - 18.1 in (45-46 cm)
S/M	21.7 - 22.8 in (55-58 cm)	18.1 - 18.5 in (46-47 cm)	M/L	22 - 23.6 in (56-60 cm)	18.1 - 18.5 in (46-47 cm)
L/XL	23.2 - 24.4 in (59-62 cm)	18.5 - 18.9 in (47-48 cm)	XL/2X-L/3XL	23.6 - 25.2 in (60-64 cm)	18.9 - 19.7 in (48-50 cm)

BALEARI



TIP TO GET THE SHOE SIZE

Use a ruler to measure the heel to toe length
and the chart to determine your shoe size.



PRODUCT DIMENSION CHART		SIZE CONVERSION CHART		
SIZE	A HEEL-TOE LENGTH	EU FOOT SIZE	US MEN'S FOOT SIZE	US WOMEN'S FOOT SIZE
5	(23 cm)	36/37	5	6
6	(24 cm)	38/39	6.5	7.5
7	(25 cm)	39/40	7.5	8.5
8	(26 cm)	41/42	9	10
9	(27 cm)	42/43	10	11
10	(28 cm)	44/45	11	12
11	(29 cm)	45/46	12	13
12	(30 cm)	47/48	13.5	14.5

MINORCA



TIP TO GET THE SHOE SIZE

Use a ruler to measure the heel to toe length
and the chart to determine your shoe size.



PRODUCT DIMENSION		SIZE CONVERSION CHART		
HEEL-TOE LENGTH CM	HEEL-TOE LENGTH CM	EU FOOT SIZE	US MEN'S FOOT SIZE	US WOMEN'S FOOT SIZE
22.9	9	36	5	6
23.7	9 1/3	37	6	7
24.6	9 2/3	38.5	7	8
25.4	10	39.5	8	9
26.2	10 1/3	41	9	10
27.1	10 2/3	42	10	11
27.9	11	43.5	11	12
28.8	11 1/3	44.5	12	13
29.6	11 2/3	46	13	14
30.5	12	47	14	14+

ANTI-SLIP NEOPRENE SOCKS



TIP TO GET THE SHOE SIZE

Use a ruler to measure the heel to toe length and
the chart to determine your shoe size.



SIZE CONVERSION CHART			
SIZE	EU FOOT SIZE	US MEN'S FOOT SIZE	US WOMEN'S FOOT SIZE
S	36 / 38	5 / 6.5	6 / 7.5
M	39 / 40	7 / 8	8 / 9
L	41 / 43	9 / 10.5	10 / 11.5
XL	44 / 46	11 / 12.5	12 / 13.5

* NOT AVAILABLE IN SIZE XL

PALMA ST / 3MM WITH GRIP



TIP TO GET THE SHOE SIZE

Use a ruler to measure the heel to toe length and the chart to determine your shoe size.



PRODUCT DIMENSION CHART		SIZE CONVERSION CHART			
SIZE	HEEL-TOE LENGTH CM	HEEL-TOE LENGTH IN	EU FOOT SIZE	US MEN'S FOOT SIZE	US WOMEN'S FOOT SIZE
XS/S	22.9 / 23.7	9 / 9 1/3	36	5 / 6	6 / 7
S/M	23.7 / 25.4	9 1/3 / 10	37	7 / 8	8 / 9
M/L	25.4 / 27.1	10 1/3 / 10 2/3	38.5	9 / 10	10 / 11
L/XL	27.1 / 28.8	11 / 11 1/3	39.5	11 / 12	12 / 13
XL/2XL	28.8 / 30.5	11 2/3 / 12	41	13	14

PALMA LT / 3MM WITH GRIP



TIP TO GET THE SHOE SIZE

Use a ruler to measure the heel to toe length and the chart to determine your shoe size.



PRODUCT DIMENSION CHART		SIZE CONVERSION CHART			
SIZE	HEEL-TOE LENGTH CM	HEEL-TOE LENGTH IN	EU FOOT SIZE	US MEN'S FOOT SIZE	US WOMEN'S FOOT SIZE
XS/S	22.9 / 23.7	9 / 9 1/3	36	5 / 6	6 / 7
S/M	23.7 / 25.4	9 1/3 / 10	37	7 / 8	8 / 9
M/L	25.4 / 27.1	10 1/3 / 10 2/3	38.5	9 / 10	10 / 11
L/XL	27.1 / 28.8	11 / 11 1/3	39.5	11 / 12	12 / 13
XL/2XL	28.8 / 30.5	11 2/3 / 12	41	13	14

Art Direction: Jenifer Chavez
 Editorial Design: Daniela López
 Covers Design: Carolina Villalba
 Lifestyle images by Cressi Ambassadors

© Cressi Sub S.p.A. All rights reserved. Reproduction, scanning, transmittal or storage, by any means of the images in this catalog, whole or in part, is prohibited without the prior written permission of Cressi Sub S.p.a

Photo by Ambassador Jason Washington

#START EXPLO- RING



 Cressi-sub USA, Inc.
3 Rosal Lane
Saddle Brook, NJ 07663
AMERICA CATALOG 2022
VPBG0021



8 43607 51104 9

INFO@CRESSIUSA.COM

 **CRESSI**
SINCE 1946