



CRESSI

**FREEDIVING &
SPEARFISHING
2023**



www.cressiusa.com

CATALOG



FREEDIVING & SPEARFISHING 2023 INDEX



CRESSI

WHO WE ARE

Join the Cressi Family	4
History	6
Territory	8
B2B - E_Learning	10
Web	11
PIM - Blog	12
Social Media	13
Our Ambassadors	14

FREEDIVING

FREEDIVING COMPUTERS

Freediving Computers	22
----------------------	----

FREEDIVING FINS

Long Blade Fins	26
Fin Accessories	41

FREEDIVING MASKS

Masks	42
Combos	56
Snorkels	58

FREEDIVING WETSUITS & NEOPRENE

Freediving Wetsuits	60
Rash Guards	67
Gloves	69
Socks	70

BUOYS & WEIGHTBELTS

Buoys	71
Weight Belts	73

FREEDIVING BAGS

Dry Bags	73
Bags	77

SPEARFISHING

SLING SPEARGUNS

Sling Spearguns	83
Shafts	92
Tips	94
Elastic Bands	95
Reels	97
Accessories	98
Bags	101

PNEUMATIC SPEARGUNS

Pneumatic Spearguns	102
Shafts	104
Speargun Accessories	105
Comparative Chart	106
Pole Spears	108
Pole Spear Accessories	110

TORCHES & KNIVES

Torches	113
Knives	114

BRAND SUPPORT

Displays	125
Flags	128
Hoodie	130
Spare Parts	132
Dimension Charts	136



JOIN THE CRESSI FAMILY

Diving, Snorkeling and Water Sports are not 3%, 5% or 10% of our business. They are 100% of our business. We are focused only on water related sports.

We have been doing this, in the bay of Portofino, since 1946 and this is **what makes Cressi different.**

SINCE 1946

CRESSI



EGIDIO CRESSI

NANNI CRESSI

ANTONIO CRESSI & MARCO CRESSI



WE USE & TEST OUR PRODUCTS OURSELVES
OURSELVES
OURSELVES
OURSELVES
OURSELVES
OURSELVES
OURSELVES
OURSELVES

WE ARE FAMILY

1930



Pinocchio



1950

1952
Pinocchio Mask, which makes equalization possible. It is a major innovation in the early '50s. It is the most famous and most sold mask in the world's history, and it is still included in the catalogue.



1953
Rondine Fins - Also in the field of fins, Cressi invented the model that has inspired all other manufacturers, the first floating model in the world.

1957
Cressi athlete Mario Catalani wins the first spearfishing World championship and get the gold medal in Jugoslavia.



1960

1965
Cressi opened one of the first workshops that specialized in producing optical masks. Thanks to Cressi, even people with visual defects could now get full enjoyment of the underwater universe.



1970

1970
Equi-vest - In 1970, Cressi was the first manufacturer in the world to produce Equi-Vest, a futuristic jacket that became one with the scuba tank, supplied by a hose that drew air directly from the first stage. This was the first incarnation of the modern BC.

1970
Rondine L long fins - The world leader of molding rubber fins, Cressi developed the Rondine L long fins, which enabled Jacques Mayol to go onto achieve his astonishing freediving records.

1979
Fins range - Alongside the various rubber fin models, a futuristic model was presented with a reinforced nylon blade, called the Rondine Gara, a fin that thirty years down the line is still going strong, and has been adopted by world class freedivers and spearfishermen the world over.



1980

1983
Jacques Mayol, the first man in the world to challenge the 100m barrier. He reached a depth of 105 meters. The episode has gone down in history, the record was obtained in the waters of the island of Elba in 1983.

1988
Apache Arbalète - Cressi produced a complete range of Arbalète spearguns to join the pneumatic guns, called the Apache, which very soon became the Champion speargun in the world.

1989
Cressi athlete Renzo Mazzarri wins the spearfishing world title in Italy.



1990

1990
Cressi continues its international expansion and the products are by now distributed in over 90 countries world wide.



1999
Cressi Athlete Umberto Pelizzari sets the freediving "No Limits Absolute Variable Weight" World Record in Portofino (Italy) reaching the depth of 150 meters.



Big Eyes Evolution

2000

2000
Big Eyes was the first mask in the world with raked lenses in an upside-down teardrop shape, an innovative form that gives the diver a complete view of all the equipment worn. They became the most widely copied and imitated mask in the world, a gratifying appreciation of how far ahead Cressi is in the design of its products.



Leonardo

2010

2011
The Leonardo dive computer watch is introduced, the first of the products designed in-house by Cressi Elettronica in order to guarantee optimum quality, safety and reliability.

2013
The French freediving champion Guillaume Néry becomes a Cressi product endorser. The Giotto dive computer watch is introduced; it processes the data from repeat multi-day dives and dives with gas mixtures and also benefits from the Cressi RGBM algorithm. The Tracina wetsuit for spearfishing is introduced in a new and exclusive camouflage Dark Digital Specter Pat Cressi.

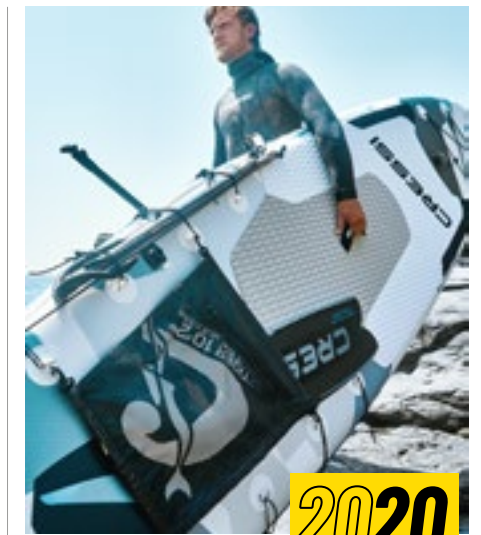

2020

2021
Hydrosports is the result of Cressi's experience, consisting of tradition, innovation and quality, since 1946. With its close relationship to the sea environment, the Cressi team has been able to develop this new collection in response to the direct needs it encountered in practice and through water tests on its products.



TODAY

The Cressi company is still entirely owned by the Cressi family, which carries on with the same passion, the work started by brothers Nanni and Egidio Cressi. Its spirit lies in the manufacturing tradition, with a clear preference for the conception and realization of its products in-house, from the initial design through to the smallest details. Cressi focuses on those who love all facets of the aquatic world. The company has never exaggerated with successful products on the market, but has instead always invested in research and development to the benefit of quality and reliability, the evolution of materials.

OUR NUMBERS

- 75 YEARS OF EXPERIENCE
- 7 BRANCHES AROUND THE WORLD
- SALES IN 100 COUNTRIES WORLDWIDE
- 100 PATENTS
- 11 TIME SPEARFISHING WORLD CHAMPION
- 7.000 REFERENCES
- UNIQUE STYLE

WHERE WE ARE

WORLDWIDE

Our headquarters is based in Genoa, and we also have eight branches: USA, Mexico, Brazil, France, Spain, China, Thailand and Australia. 70% of our products are made in Italy in our own factory, in Genoa. 10% of our products are made in our own production facility in Hungary and the remaining 20% is sourced from selected high-quality suppliers from Asia.

We have around 10,000 shops all over the world, and our products are sold in over 100 countries.

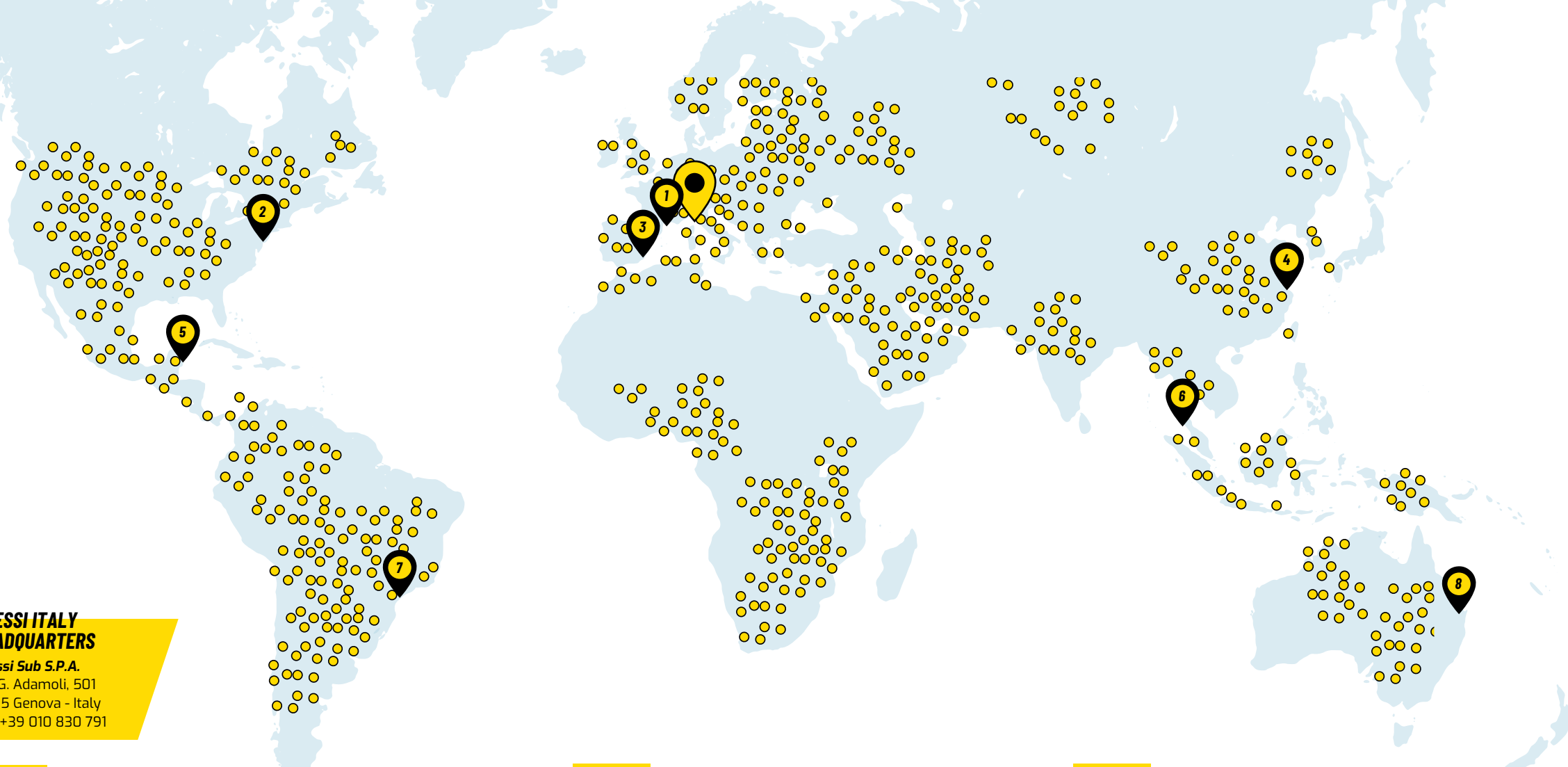

CRESSI ITALY HEADQUARTERS

Cressi Sub S.P.A.
Via G. Adamoli, 501
16165 Genova - Italy
Tel. +39 010 830 791



1980

CRESSI FRANCE

Cressi Sub France
Espace La Gaude, 9565 Route De Saint Laurent
06610 La Gaude - France
Tel. +33 049 329 0318



1987

CRESSI U.S.A.

Cressi Sub U.S.A.
3 Rosol Lane, Saddle Brook - NJ 07663 - USA
Phone: (800) 338 9143
Phone: (201) 594 1450



2017

CRESSI MEXICO

Cressiwater S.A.P.I De C.V.
Central de Abastos, Carretera - Cancun-Aeropuerto km 17, Cancun
Quintana Roo. C.P.77565 - Mexico, VAT NO.CRE161110812
Phone: +52 1 554 162-2052



2018

CRESSI THAILAND

Cressi South East Asia Ltd
135/6-7 Moo 4 - Patak Road, Tambon Rawai
Amphur Mueang, Phuket - Thailand 83130
Mobile: +66 (0) 643971234



1992

CRESSI ESPAÑA

Cressi-Sub España S.A.
NIF: A60130978 - C/Castellassa, 24 Nave 3, Poligono Can Petit 08227
Terrassa Barcelona - Spain
Tel. +34 937 841 888



2013

CRESSI CHINA

Cressi China Watersports Products Co.,Ltd
No.4 Zhuhai Road
Kunshan City - Jiangsu province, China
Phone +86 512-3668 0846



2019

CRESSI BRASIL

Cressi Brasil COM. MAT. ESP. LTDA
Avenida Padre Anchieta, 175 - Jordanópolis, São Bernardo do Campo
SP, 09891-420
CNPJ: 35.112.958/0001-59



2022

CRESSI AUSTRALIA

Cressi Australia
64 Edison Crescent, Baringa
Queensland Australia, 4551
marketing@cressi.com.au

B2B

THE EXCLUSIVE AUTHORIZED DEALER ONLINE WEBSITE

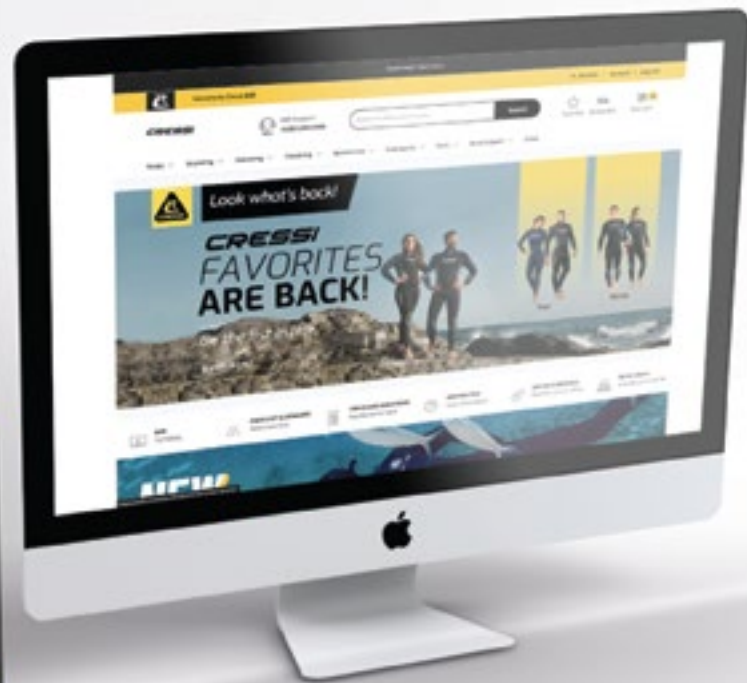

B2B.CRESSIUSA.COM

WHAT IS IT?

We have developed an online order system, meaning you can now place your order at Cressi as you shop on any e-commerce website.

HOW DOES IT WORK:

Authorized and in coordination with your Territory Sales Manager, you will receive an invitation email from b2b@cressiusa.com

HOW TO ACCESS:

1. Contact your Cressi Sales Representative or Cressi USA office and ask for your credentials
2. Go to b2b.cressiusa.com, click on dealer area, type your credentials, and log in to place your order

THE FEATURES:

- Enhanced Experience To Order Easy And Fast. Product Information, Technical Features, Descriptions, Photos
- Direct Access At Any Time To Order Product
- Check-In Real-Time The Complete Cressi Catalog Products Inventory And Immediate Availability.
- Orders Management, Order History , And Shipping Information
- Backorder Management, With Accurate Estimates Of Arrival Times.
- Newsletter With Deals, Specials, Outlet

CRESSI E_LEARNING PLATFORM

CRESSI LMS (ONLINE E-LEARNING MANAGEMENT SYSTEM)

Bringing all things Cressi to you in a simple and easy to access way. The E- Learning Management system is made to educate our dealers on a wide range of topics from product, classes and certifications, all while in the comfort of your home or shop!

cressi.mclms.net

REGISTER FOR FREE AND START LEARNING ONLINE TODAY

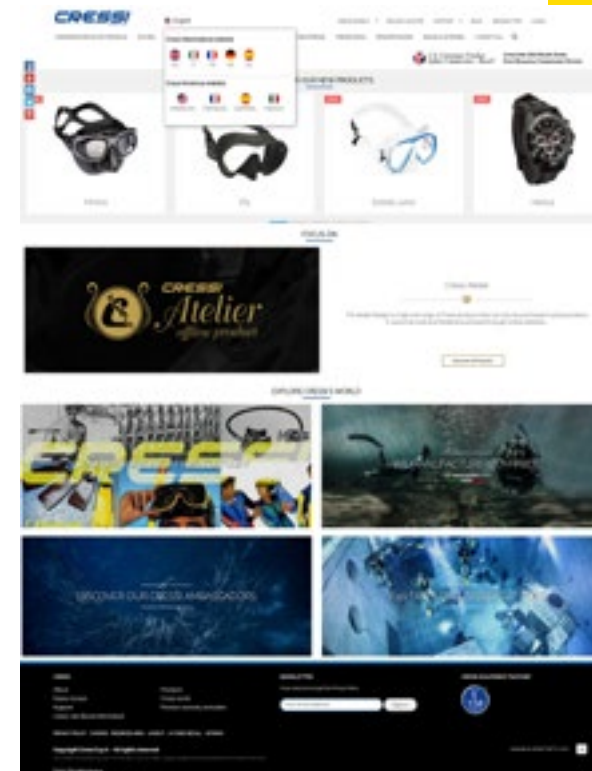

OFFICIAL WEB SITE

CRESSIUSA.COM

DESIGNED IN 5 DIFFERENT LANGUAGES

- COMPLETE CRESSI CATALOG PRODUCTS PROFILES
- OPERATING MANUALS
- SOFTWARE INTERFACES & MANUALS
- SIZE CHARTS
- PRODUCT REGISTRATION
- PRODUCT PICTURES
- LIFESTYLE IMAGES
- CRESSI VIDEOS
- CRESSI LOGO

RESERVED PROFESSIONAL AREA

/// DOWNLOADING AREA

Visit www.cressi.com and access the Professional Area. The Professional Area is only dedicated to Cressi Authorized Dealers. In order to access it, you will need a user name and password that will be supplied to you by The Cressi America Company.

1. GO www.cressiusa.com
2. LOGIN PROFESSIONAL AREA:

Login and password:
Supplied to you by The Cressi America Company.

Forgot password?
Enter your username and we will send a reset password link to the email on your account.

LOGIN : USERNAME AND PASSWORD

Warning: This area of the Cressi-sub-website and its contents are exclusively reserved for Cressi Authorized Dealers. Technical documentation will be available only for Cressi-sub Service Centers.

 DOWNLOAD

ALL CRESSI DOCUMENTS YOU NEED, READY ON YOUR: **CRESSI PROFESSIONAL AREA**



PIM

(PRODUCT INFORMATION MANAGEMENT)

1. GO TO www.cressi.com/cressiusadc
2. SELECT THE USA DIGITAL CATALOG
3. EXPLORE PRODUCT PROFILE

THE CRESSI'S PIM IS THE CENTRAL REPOSITORY OF ALL OF THE INFORMATION REGARDING THE PRODUCTS.

The Digital Catalog will help you to quickly find what you need, increasing your knowledge and experience. It is made to share all the possible information of a product, even images, videos, user guides, advertising material.

- Do you need an image of a product? Access the Digital Catalog and download it.
- Do you need to know the lift capacity of a Cressi BC? Search on the Digital Catalog and you will find it.
- Where are the fins size conversions charts? The answer is on the Digital Catalog.
- Do you need the part number for a replacement part for the Cressi product? The Digital Catalog is made for it.
- Do you need data for your e-commerce store? Just download them from the Digital Catalog.

POWERED BY:  SALSIFY

www.cressi.com/cressiusadc



SOCIAL MEDIA

INTERNATIONAL ACCOUNTS

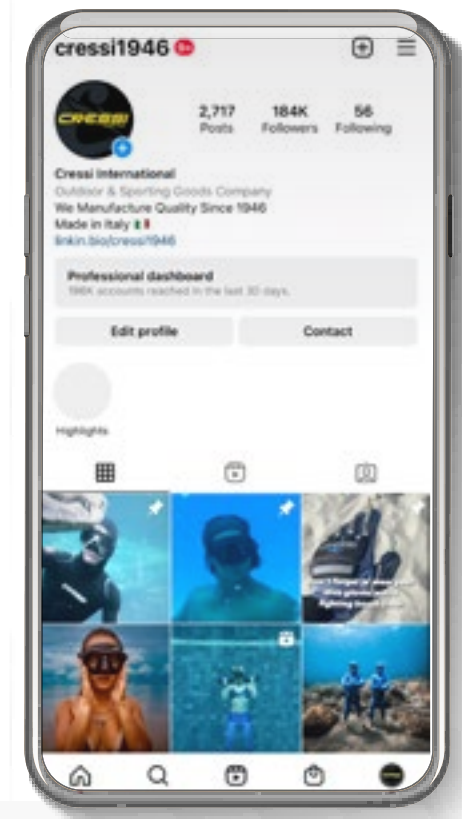

- FACEBOOK**
OFFICIAL CRESSI PAGE
[cressigear](#) 232,639
OFFICIAL HYDROSPORTS PAGE
[cressi.hydrosports](#) 12,542
OFFICIAL SPEARFISHING PAGE
[cressi.spearfishing](#) 186,824
- INSTAGRAM**
OFFICIAL PAGE
[cressi1946](#) 184 K followers
- TIKTOK**
OFFICIAL PAGE
[@cressi1946_international](#) 1,360 Followers
- LINKED-IN**
OFFICIAL PAGE
[Cressi International](#) 4,066K Followers
- YOUTUBE**
OFFICIAL CHANNEL
[Cressi](#) 10.1k Subscribers
- TWITTER**
OFFICIAL TWITTER
[cressi1946](#) 3,548 Followers

CRESSI BLOG

/ CO-OP JOURNAL

BLOG.CRESSI.COM

SINCE 2020, Cressi launch the Cressi CO-OP JOURNAL, where The Dive Community near Cressi will share awesome news and content.

- **FROM THE FIELD** From the sea of Liguria where Cressi had its beginnings to the oceans of the world, Cressi celebrates its passion for the underwater world.
- **WHAT'S NEW AT CRESSI** Our latest advances in gear technology, product design, software innovations and infrastructure.
- **ECO-NEWS** Cressi is committed to doing business and creating products that contribute to a sustainable future for our customers and the planet.
- **COMMUNITY** Cressi has transformed how it does business. In its earliest days, the diving and spearfishing community was a closely connected fraternity, a brotherhood of water lovers. Through tireless innovation and a commitment to this watersports community, Cressi continues to be an integral part of the community and the catalyst for change. At Cressi, every innovation is a step toward the future.
- **CRESSI AMBASSADORS** Our dedicated community of Lifestyle Ambassadors are serving to be a force for good by working to protect the ocean we all love. They inspire us with their stories and are role models for future generations that will follow them. For more than 75 years, Cressi has supported water lovers working to create innovative gear, increase safety in the sports of scuba diving, free diving and spearfishing.
- **SPEARFISHING** The best way to observe a fish is to become a fish." — Jacques-Yves Cousteau, a French naval officer, explorer, conservationist, filmmaker, innovator, scientist, photographer, author and researcher.

2022 SPECIAL MEDIA PROJECTS

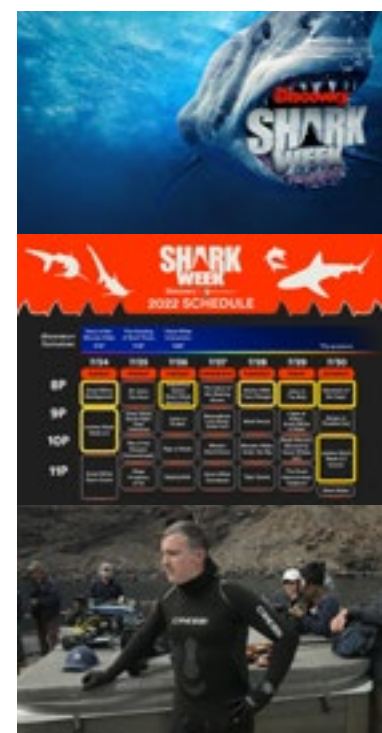

SHARK WEEK 2022

Shark Week is seven-day marathon documentation about sharks that airs annually on Discovery Channel since 1988. Every year it features some popular celebrities who go underwater paying a visit to the apex predator. Last week of July, Discovery Channel's Shark Week is an annual, Jaws-dropping spectacle featuring more than 30 hours of original programming about one of nature's most feared predators.

2022 SHOWS

- Great White Battleground
- Jackass Shark Week 2.0
- Impractical Jokers: Shark Week Spectacular
- Sharks! With Tracy Morgan
- Jaws vs The Blob
- Monsters of the Cape

CIVE 2022 SECOND CRESSI INTERNATIONAL VIRTUAL EVENT



The Second edition of the Cressi International Visual Events was on October 22, 2022. It was a compilation of live virtual sessions that took place from country to country, starting in Australia and ending in South America. We have a robust agenda that includes different topics, many special guests, and our technicians that introduced the new 2023 Cressi products. It was an event to be with the Cressi Family, colleagues, partners, retailers, and media for 24 hours non-stop with a lot of content.



WHAT'S NEW AT CRESSI



COMMUNITY



ECO-NEWS

THE OCEAN IS WHERE WE BELONG

Our dedicated community of Lifestyle Ambassadors are serving to be a force for good by working to protect the ocean we all love. They inspire us with their stories and are role models for future generations that will follow them. For more than 75 years, Cressi has supported water lovers working to create innovative gear, increase safety in the sports of scuba diving, free diving and spearfishing. Today, more than ever, we need people who are willing to tackle some of the most pressing issues impacting the oceans of the world. That mission unites all our Ocean Ambassadors. Meet them below – and then find your passion and take action.



OUR AMBASSADORS



SCUBA DIVING AMBASSADORS

"Every time I slip into the ocean, it's like going home." — Sylvia Earle, American marine biologist, explorer, author, and lecturer.

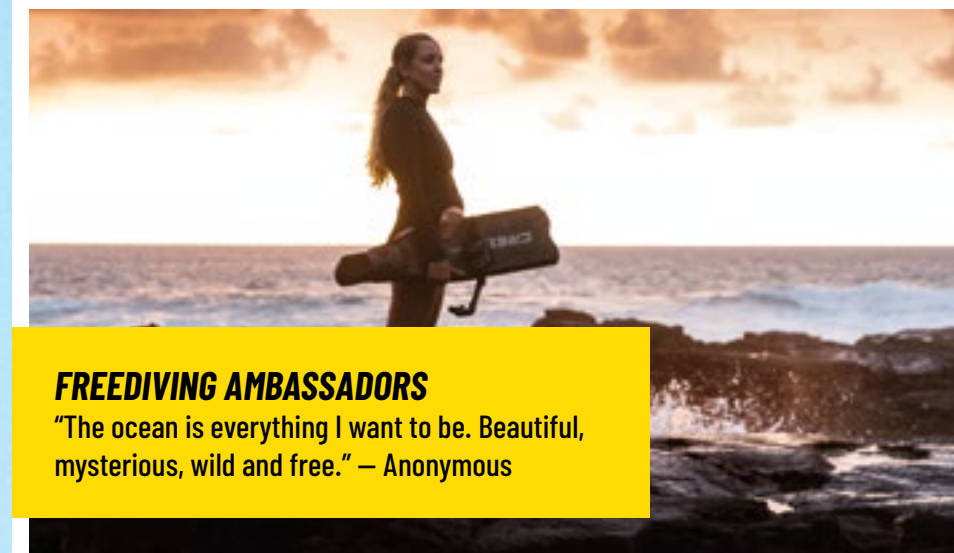

FREEDIVING AMBASSADORS

"The ocean is everything I want to be. Beautiful, mysterious, wild and free." — Anonymous



SPEARFISHING AMBASSADORS

"The best way to observe a fish is to become a fish." — Jacques-Yves Cousteau

/ OUR AMBASSADORS

ASIA BRYNNE



[@asiabrynne](#)

I picked up my first disposable film camera at the age of 8 and never stopped shooting. The ocean is a place away from all of the noise, where you don't have to use words, time doesn't exist, and you can share space with animals. Being underwater is a break from the busyness of life.

THE BUCKET LIST FAMILY

worldwide



[@thebucketlistfamily](#)

The Gee family, just a typical family working from all over the world as Family Travel Journalists! Their story began in 2015, when they decided to sell everything and leave home for a trip around the world. They started an Instagram and YouTube channel called, The Bucket List Family.

DANILO CALLEGARI

Italy



[@callegaridanilo](#)

He explored the most inhospitable places in the world, swam in the oceans and climbed the highest mountains, he crossed entire continents by bicycle... then four deserts and the largest glacier in Europe. His mission is to fuse air, land and water into a single adventure.

GIADA CAMPANELLA

Italy



[@giadacampanella](#)

I am a dynamic yoga teacher, yoga for me is a connection to nature. In the water we are put to the test and we can only abandon ourselves to the water that envelops you and hugs you gently. When I dive underwater my mind is canceled, the body is abandoned and there are no other sounds other than that of your heart, then my mind calms down.

FABIO ROLLERI

Italy



[@fabioroller](#)

Breathe is a project that aims to raise awareness of the beauty of underwater nature. We were born in contact with the sea and water has always been part of us. Below the water level everything stops, it's just you, your heartbeat and your room! Calm rules everything around you and it is at that point that you realize how wonderful there is underwater.

IGOR D'INDIA

Italy



[@igordindia](#)

Igor has been able to combine his passion for outdoor adventure with his training in underwater filmmaking, camera drone pilot operation and advanced open water diving. He is deeply committed to participating in the global community who are fighting to protect the ocean.

THEO KNEVEL

Netherlands



[@theoknevel](#)

Theo is a scuba diving and advanced free diving instructor. He joined Cressi following a 10-plus-year career as a frogman in the Special Boat Service. He has been able to spread his passion for diving throughout the Caribbean. He is co-founder and chairman of the War Veterans Foundation.

BROOKS LAICH

USA



[@brookslaich](#)

He's a Canadian former professional ice hockey forward. He played over 750 National Hockey League games. Brooks is a multi-athlete and a sports lover, so what better way to kick off the day? A little snorkel session when the water is calm and fishes and turtles are active.

SHAWN MAHONEY

USA



[@thebeaconscollective](#)

All of my first gear was Cressi, and most of it since has been. The early pioneers of freediving wore Cressi and I saw how successful they were so I said why not emulate what they do? I loved and still do my Cressi Gara 2000's. That's why it was a no brainer to say yea to being a Cressi ambassador.

FRANCESCO MAGISTRALI

Italy



[@beyond.exploration](#)

Francesco is the creator of the Beyond Exploration brand. His family, his friends and his collaborators are all part of this team. In the name of Beyond Exploration's mission itself, Francesco's gaze is always turned towards the future. Adventure, travel and exploration are the means to deeply know the world, the Mystery and Humanity.

LLUIS MASUET

Spain



[@masuleti_underwater](#)

In 2016, tired of the business world, he tried scuba diving and began to learn underwater photography, a combination that in just a few short years made this Barcelona citizen a renowned, award-winning photographer. Lluís currently travels all over the world capturing beautiful images.

LEO MORALES

Mexico



[@leomoralessbuzo](#)

For many, scuba diving is an adventurous, recreational activity. For Cressi ambassador Leo Morales, scuba diving was therapy and the pathway to a second chance at life. After surviving a rare form of cancer, it was scuba diving that helped Leo to heal and find a deeper meaning into the purpose of his life.

REGINA DOMINGO

Mexico



[@regisunday](#)

Regina is part of the Nakawe project. The mission is to promote the conservation of critical ecosystems and species by working directly with communities to promote sustainable solutions to local environmental issues and educate local populations on the importance of biodiversity.

KRYSTAL DORN

USA



[@krystalklear](#)

Krystal moved to Hawaii, when she began photographing underwater and free diving. She is well known for capturing artistic images underwater, from mermaid photography to conservation awareness projects. Her mission is to help raise awareness for animal species.

GIULIA GABRIELLESCHI

Italy



[@gabbri1996](#)

Giulia Gabrielleschi is an Italian swimmer, specialising in open water swimming. At the World Championships, she won a silver medal (Gwangju 2019) and a bronze medal (Budapest 2017) in the 5 km team event. The challenges continue and year after year she brings home excellent results.

ROBERTO OCHOA

Ecuador

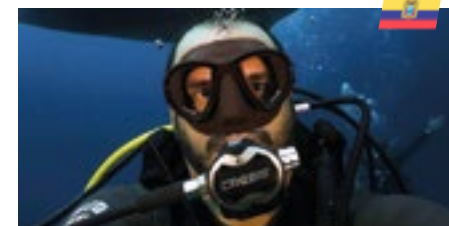

[@robertochoahe](#)

Roberto Ochoa is a Videographer for Planeta Azul, he started making wildlife videos at the age of 25 in the Galapagos Islands, Africa and North America. Beneath the world's waters lie landscapes, species, vegetation, and populations as diverse and splendid as those on land.

OCEAN RAMSEY & J. OLIPHANT

Hawaii



[@oceanramsey](#)

"Mr. and Mrs. Sharks." She is a marine biologist, shark and marine conservationist, professional freediver and scuba instructor, surfer, swimmer and professional model. Juan grew up surfing, he became a divemaster. He traveled the world with to help combat illegal fishing and whaling.

CRAIG O'CONNELL

USA



[@thesharkdoctor](#)

I'm from a small town located several hours from the ocean. But I always had a fascination with the ocean, a fascination that really came to fruition during my first shark encounter in the Florida Keys when I was 14. My free diving and scuba career began and has been growing ever since.

CHRISTOPHER GILLETTE

USA



[@gatorboys_chris](#)

I'm born in Florida and have spent my life around the water. I love the freedom, weightlessness, and otherworldly views of diving. I try to use my passion to teach others about aquatic wildlife in the hopes they will learn to love them too, and ultimately help protect these fragile ecosystems.

KAYLEIGH & CAMERON GRANT

Hawaii



[@mermaid.kayleigh](#)

Kayleigh and Cameron are passionate divers who strives to educate and encourage people to protect our oceans. As a marine conservationist, Kayleigh understands the importance of educating people about ocean conservation. Through her work at One Ocean Diving, she's able to inspire people's in protecting the world's sharks and marine life.

PHILIP HAMILTON

UK



[@philip.hamilton.photography](#)

Philip Hamilton, filmmaker, photographer and author, is best known for his passion and dedication to ocean conservation. He has over thirty years diving and sailing experience and has documented most marine animals on the planet, from the majestic Blue whale to the smallest underwater critters.

NATALIE PARRA

USA

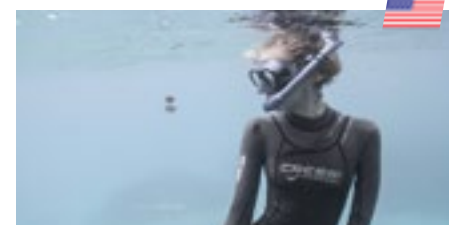

[@natalieparra](#)

I'm from Southern California. I grew up playing in the ocean, but it wasn't until I was visiting the island of Oahu prior to moving there that I tried freediving for the first time. It felt like flying and I couldn't get enough of it. I started researching, taking courses and learning from fellow free divers.

CRAIG PARRY

USA

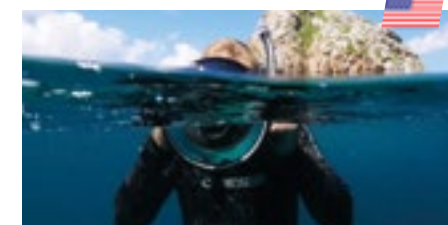

[@craigparryphotography](#)

It was his parent's gift of a disposable water proof camera that set him on the path to his passion. While most kids were reading comics, Craig was immersing himself in early editions of Australian Geographic. Finally the 35mm SLR set the course for Craig's future.

STEVEN PAYNE

USA

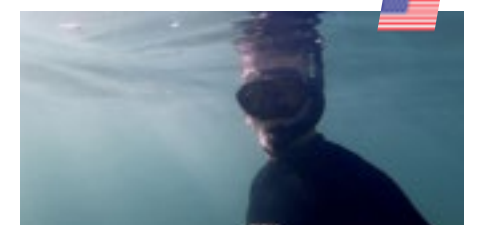

[@sevenpayne](#)

Steven grew up surrounded by open spaces, farms, and lakes; he loved exploring and seeing animals. His family moved to Florida, which cemented his love for the ocean. Steven is currently in the process of deploying artificial reefs: His nonprofit, The Reef Genesis Corporation, is his passion.

/ OUR AMBASSADORS

PIRRY

Colombia



[@pirryofficial](#)

Pirry is a Colombian journalist, writer, photographer, documentalist and important influencer that is dedicated good part of his journalist work talking about the Ocean and denouncing problems such as illegal fishing, pollution and many other difficulties facing the seas.

PRO RECCO WATERPOLO 1913

Italy



[@prorecco](#)

Pro Recco Waterpolo 1913 is a water polo club from Recco and is to this day the most successful team in the world. The sea as an indissoluble link in the history, the symbiotic relationship with Liguria, the sacrifice and the constant search for innovation to win the daily challenges.

ANDREW RAAK

USA



[@raakbottomimaging](#)

Passionate about all aspects of the marine environment, Andrew has worked as a dive professional for more than a decade. He has a degree in Marine Science, a captain's license and dive instructor certification. He has traveled the world photographing in amazing locations.

VOYAGES OF AGAPE

USA



[@voyagesofagape](#)

Agape is a 1984 Tayana Vancouver 42', hull #93. "Agape" means unconditional love. She is a true blue water cruiser, and has already seen much of Mexico, the South Pacific, and beyond. For us Agape is home. She is a safe and trustworthy vessel that will ferry us to the less seen places of the world.

JASON WASHINGTON

Cayman islands



[@caymanjason](#)

For the past two decades, Jason has been a leader in the Cayman Islands water sports community. A 2017 International Scuba Diving Hall of Fame honoree, Jason's focus both locally and abroad has been on protecting the delicate marine life found in the waters of the C. Islands.

CHRISTINE WEST & ADAM MAIRE

Hawaii



[@christine_regent_west](#)

After working as scuba instructors, adding cold-water diving was the greatest modification to their portfolio. Working together diving on a project in Alaska opened their eyes wide to documenting undersea life in extraordinarily different environments from the warm waters where they began.

MARIO RIGBY

Turks&Caicos



[@mariorigby](#)

In 2018, Mario completed his crossing Africa journey, a two-year trek walking and kayaking from Cape Town to Cairo. This expedition allowed him to connect with communities and share their message and stories. His goal was to inspire people globally to get out, be brave, and see the world.

ARIANNA ROMERI

Italy



[@ariannaromeri_art](#)

I grew up surrounded by equipment and the perfume of neoprene, watching my dad dive and waiting for my moment. I signed up for a freediving course. It wasn't love at first sight, I learned to appreciate it when it became the key to getting to know myself, through its timing, calmness and sensitivity.

CHIARA SALOMONI

Italy



[@chiaraphoto](#)

I remember snorkeling all over the Mediterranean Sea, using my father's Cressi fins, which were oversized for my feet. I got into scuba and moved to the U.S. to follow my dream of becoming an underwater photographer, so that I would have the chance to be in the water as much as possible.

JACINTA SHACKLETON

Australia



[@jacintashackleton](#)

Jacinta Shackleton is a marine biologist and educator at Lady Elliot Island, located right on the Great Barrier Reef. You might recognize her name from her stunning work filming and photographing marine animals. Most notably, she is 1/50 people to have seen and filmed an Ornate Eagle Ray.

JONATHAN SCHUTTE

Cayman islands



[@jonschutte](#)

For as long as I can remember I have had a passion for traveling and telling stories. I love to create content and share my adventures. Through my project Nauti Nomad I hope to inspire you too to embrace life and pursue your passions, respect our planet and help each other!

SULUBAAI FOUNDATION

Philippines



[@sulubaaifoundation](#)

Our approach consists in developing our objectives and making our site a model of sustainable management and a leader in ecosystem restoration. We believe that ecosystem preservation requires the involvement of local communities, and that the active management of marine protected areas is necessary to achieve results to deal with existing issues.

LUCA TIXI

Italy



[@outdoorportofino](#)

I was born and raised in Recco, at the time of high school, in a period of environmental militancy, the enlightenment arrives: I understand that my job will be to bring people into nature! After graduating in Marine Environmental Sciences at the University of Genoa, I founded Outdoor Portofino.

FEDERICO TRAVERSO

Italy

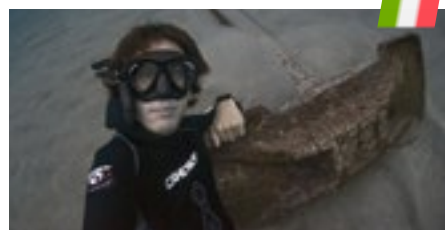

[@skullphoto_aka_surfskull](#)

He is a young Italian designer and collaborates with Cressi for many years. Federico is passionate about the sea in all its forms, practice surfing and freediving but instead of hunting, he prefers to take pictures and videos. He starts each day with a morning swim session in the sea.

NANJA VAN DEN BROEK

Netherlands



[@nanjafreediver](#)

Nanja van den Broek started freediving in 2001 and in her first competition she immediately set two national records. In 2015, she set a new world record in the discipline Variable Weight with a dive to -130 meters, this record is also her 30th national record.

/ OUR AMBASSADORS



CRESSI, EQUIPMENT PARTNER OF Y-40®



In March 2019 Cressi officially became the partner of Y-40® The Deep Joy, the deepest pool in Europe. From that moment on, the recreational diving and freediving equipment available at Y-40® is provided by Cressi.

Y-40® The Deep Joy is the place where everything is possible, where you can live the most amazing aquatic experiences.

4,300 cubic meters of thermal water where there are free diving and scuba diving courses. It's a safe environment for professional exercises and scientific research, in addition to being an amazing film set and area for photographic and advertising services. Y-40® has an area of 21x18m; the maximum depth is 42.15 meters with different platforms at intermediate depths and caves for technical activities.

The deep pool can be visited, it is possible to walk in the transparent tunnel that crosses the structure, discovering the magic of this big human aquarium.



[@y40_thedeejoy](#)

CRESSI FREEDIVING
2023 COLLECTION

The range of blues that will be used to reflect the brand personality of Cressi's Freediving line go from a calming teal to a meditative inky-blue. Only freedivers know the feeling of testing their limits – to push their body to explore underwater by using only their breath and the equipment that helps ensure their safety – Cressi's Freediving products are ones that freedivers can trust with confidence. From low-profile masks to easy-breathing snorkels to high-performance fins, Cressi's freediving products offer freedivers the opportunity to experience freedom, adventure, community, self-expression, mindfulness and personal challenge.

CRESSI

**EXPERIENCE
YOUR FREEDOM**

FREEDIVING



- METAL BEZEL
- PROTECTION ALGORITHM FROM TARAVANA
- LONG-LIFE BATTERY
- 4 OPERATIVE MODES
- MINERAL GLASS
- SILICONE STRAP WITH POLYAMIDE CORE

KING NEW COLOR 2023

FREEDIVING COMPUTER WATCH

With a case diameter of only 48 mm and a highcontrast display of 35 mm, King is an extremely compact watch-computer specific for freediving. This innovative product boasts an algorithm developed in Cressi, which protects the freediver from the risk of Taravana, and a function that avoids the risk

of pulmonary edema. Mineral glass, heavy duty case with steel buttons for resistance to water pressure up to 120 m | 393 ft, metal bezel in AISI 316 steel with surface treatment and Inkfilled strap to prevent tears and breakage) with stainless steel buckle.



CODE	COLOR	CASE PACK
K5842020	Blue	4
K5842030	White	4
K5842050	Black	4
K5842085	Orange	4



- SPECIALIZED retailer product
- MADE IN ITALY

TECHNICAL FEATURES

- High contrast display
 - Easy access menu
 - 12/24 time format with calendar and seconds
 - Precision stopwatch
 - Timer (countdown)
 - Second time setting
 - Alarm clock
 - Backlit display
 - Tide indicator
 - Low battery indicator
 - Metric or imperial units
 - Long-lasting battery
 - Sleep mode to increase battery life
 - Battery replaceable by user
- FREE (FREEDIVING) PROGRAM**
- Taravana risk reduction algorithm with 8 levels
 - Pulmonary edema risk reduction function with approach dive calculation
 - Display of all diving parameters
 - Depth
 - Temperature
 - Dip counter
 - Maximum dive depth
 - Dive time
 - Length of surface interval between each dive
 - Length of diving session
 - Maximum descent and ascent speed indication
 - Depth, dive time and surface interval alarms
 - Recovery time alarm
 - Hydration alarm
 - Alarms that can be set at dive phase
 - Fresh/salt water setting
 - Lock mode for snorkeling or swimming activities
- LOGBOOK**
- Variable data logging interval
 - Available during the diving session
 - Indication of session parameters and of each dive
- INTERFACE**
- Optional with visualisation of diving profile

SILICONE PROTECTIVE LENS INCLUDED



ELITE CASE INCLUDED



ACCESSORIES

CODE	PRODUCT
KZ810000	Strap Extender For Dive-Watch Computer - Black/Black
K5890000	Silicone Screen Protector For Dive Watch
K5822001	Bt Interface For Dive-Watch Computer
KZ700000	Elite Protective Case For Dive Computer

SPARE PARTS

CODE	PRODUCT
KZ842050	Silicone Watchband - Black For King
KZ842020	Silicone Watchband - Blue For King
KZ842085	Silicone Watchband - Orange For King
KZ901000	O-Ring + Screws For Watch-Style Computer
KZ805099	Screws W/ Nut (1 Pair) For Dive Watch Computer Band

- MINERAL GLASS
- HEAVY DUTY CASE
- PROTECTION ALGORITHM FROM TARAVANA
- EDEMA PROTECTION FUNCTION
- USER FRIENDLY MENU
- LONG-LIFE BATTERY

NEPTO

FREEDIVING WATCH COMPUTER

With a case diameter of only 48 mm and a high-contrast display of 35 mm, Nepto is an extremely compact watch-computer specific for freediving.

This innovative product boasts an algorithm developed in Cressi, which protects the

freediver from the risk of Taravana, and a function that avoids the risk of pulmonary edema. Mineral glass, heavy duty case with steel buttons for resistance to water pressure up to 120 m | 393 ft, rubber strap with stainless steel buckle.



BLUE



BLACK



GREEN

CODE	COLOR	CASE PACK
K5841020	Blue	4
K5841050	Black	4
K5841098	Green	4



PACKAGING



SPECIALIZED retailer product MADE IN ITALY

TECHNICAL FEATURES

- High contrast display
- Easy access menu
- 12/24 time format with calendar and seconds
- Precision stopwatch
- Timer (countdown)
- Second time setting
- Alarm clock
- Backlit display
- Tide indicator
- Low battery indicator
- Units in Metric or Imperial system
- Long-lasting battery
- Sleep mode to increase battery life
- Battery replaceable by user
- Long-lasting battery: CR2450 3V lithium

FREE (FREEDIVING) PROGRAM

- Taravana risk reduction algorithm with 8 levels
- Pulmonary edema risk reduction function with approach dive calculation
- Display of all diving parameters
- Depth
- Temperature
- Dive calculator
- Maximum dive depth
- Dive time
- Length of surface interval between each dive
- Length of diving session
- Maximum descent and ascent speed indication
- Depth, dive time and surface interval alarms
- Recovery time alarm
- Hydration alarm
- Alarms that can be set at dive phase
- Fresh/salt water setting
- Lock mode for snorkeling or swimming activities

LOGBOOK

- Variable data logging interval
- Available during the diving session
- Indication of session parameters and of each dive

INTERFACE

- Optional with Visualization of diving profile.

- PROTECTION ALGORITHM FROM TARAVANA
- EDEMA PROTECTION FUNCTION
- USER FRIENDLY MENU
- LONG-LIFE BATTERY



OPTIONAL ACCESSORIES

STRAP EXTENDER | SILICONE PROTECTIVE LENS | BT INTERFACE

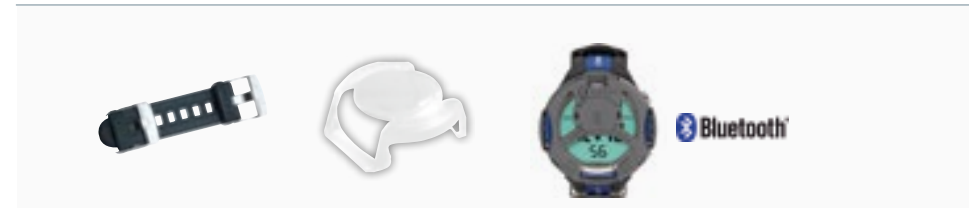

ACCESSORIES

CODE	PRODUCT
KZ810000	Strap Extender For Dive-Watch Computer - Black/Black
K5890000	Silicone Screen Protector For Dive Watch
K5822001	Bt Interface For Dive-Watch Computer
KZ700000	Elite Protective Case For Dive Computer

SPARE PARTS

CODE	PRODUCT
KZ840020	Watchband - Black/Blue For Neon/Nepto
KZ840055	Watchband - Black/Black For Neon/Nepto
KZ841098	Watchband - Black/Green For Nepto
KZ901000	O-Ring + Screws For Watch-Style Computer
KZ805099	Screws W/ Nut (1 Pair) For Dive Watch Computer Band

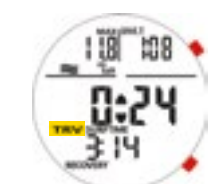

TARAVANA PROTECTION ALGORITHM



BLOODSHIFT PROTECTION ALGORITHM



TIDE LEVEL INDICATOR



SINGLE DIP LOGBOOK



FINN

FREEDIVING

GARA TURBO CARBON

29 DEGREE ANGLED INTERCHANGEABLE BLADE SYSTEM

Following the Impulse project, we have successfully transferred the same design parameters for S-shaped undulating deformation to this innovative carbon fin. This particular movement permits a notable accumulation of elastic potential energy in the blade, which is released in the return kick, transforming into thrust. The effect has been achieved using a finite element program that enables the performance offered by carbon fiber to be exploited to the full. The blade is all-carbon-fiber with an angle of 29°. The fiber is imported from Japan. The shaped and processed sheet is then produced in a specialist plant in Turkey.

The blade is subsequently finished with an industrial co-molding process at Cressi's Genoa plant. The elevated chemical bonding

achieved between blade and rail, effectively creating a single piece, has permitted the elimination of the rigid glue that prevented the carbon fiber blade from flexing naturally. The thermoplastic rubber used for the water channeling rails is extremely flexible and soft so as not to undermine the intrinsic characteristics of the carbon fiber. The blade is, therefore, less fragile and more protected by the rubber. The end result is a very light fin, which manages to exploit the maximum flexion of the carbon in every square millimeter.

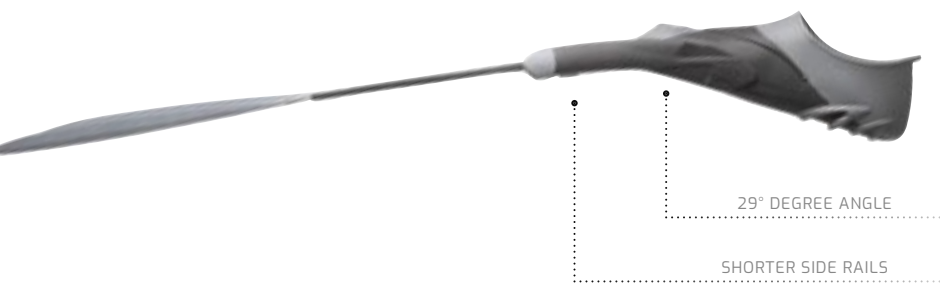

CODE	SIZE	CASE PACK
BH165036	36/37	3
BH165038	38/39	3
BH165040	40/41	3
BH165042	42/43	3
BH165044	44/45	3
BH165046	46/47	3



TECHNICAL FEATURES

- Excellent propulsive performance 29 degree angled interchangeable carbon blade
- Modular detachable fin
- Superior performance
- Superior comfort
- Self adjusting foot pocket diving even during desaturation



GARA MODULAR INSOLE INCLUDED

The insole for Gara Modular fins is recommended for use with thin socks in temperate waters because it improves the kick performance. The semi-rigid material of the insole is completely recycled. The insoles are supplied as a pair (right and left foot) and can be cut into their shape in three different sizes, according to pre-printed guidelines.

- Down-size Gara Fins foot pocket preformed sole
- Easily adjust size
- Non-corrosive plastic construction



ACCESSORIES

CODE	PRODUCT
BZ175032	Rubber Fin Keeper (Pair) - Black [S]
BZ175033	Rubber Fin Keeper (Pair) - Black [M]
BZ175034	Rubber Fin Keeper (Pair) - Black [L]
BZ180022	Insole For Gara Fins

SPARE PARTS

CODE	PRODUCT
BZ180020	Gara Modular Assembly Kit
BH015036	Gara Modular Turbo Foot Pocket [36/37]
BH015038	Gara Modular Turbo Foot Pocket [38/39]
BH015040	Gara Modular Turbo Foot Pocket [40/41]
BH015042	Gara Modular Turbo Foot Pocket [42/43]
BH015044	Gara Modular Turbo Foot Pocket [44/45]
BH015046	Gara Modular Turbo Foot Pocket [46/47]

FIT SIZE



To maximize performance and comfort, wear fins with:

<input checked="" type="checkbox"/>	<input checked="" type="checkbox"/>	<input type="checkbox"/>	<input type="checkbox"/>
BARE FOOT	NEOPRENE SOCKS	NEOPRENE BOOTS	HARD SOLE BOOTS

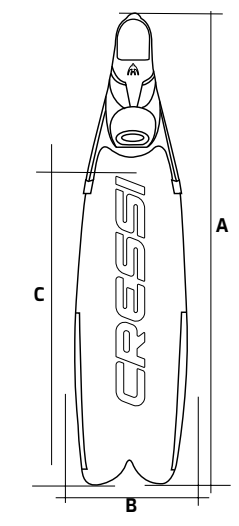

FIN SIZE	PRODUCT DIMENSION CHART			FIN HEIGHT FIT	SIZE CONVERSION CHART			
	A LENGTH	B WIDTH	C BLADE		EU FOOT SIZE	UK FOOT SIZE	US MEN'S FOOT SIZE	US WOMEN'S FOOT SIZE
36/37	671 mm 26.4 in	215 mm 8.5 in	430 mm 16.9 in	83 mm 3.3 in	36 / 37	3 / 4	4 / 5	5 / 6
37/38	683 mm 26.9 in	215 mm 8.5 in	430 mm 16.9 in	84 mm 3.3 in	37 / 38	5 / 6	6 / 7	7 / 8
39/40	700 mm 27.6 in	215 mm 8.5 in	430 mm 16.9 in	87 mm 3.4 in	39 / 40	6.5 / 7	7.5 / 8	8.5 / 9
41/42	712 mm 28.0 in	215 mm 8.5 in	430 mm 16.9 in	92 mm 3.6 in	41 / 42	8 / 9	9 / 10	10 / 11
43/44	725 mm 28.5 in	215 mm 8.5 in	430 mm 16.9 in	97 mm 3.8 in	43 / 44	10 / 10.5	11 / 11.5	12 / 12.5
45/46	734 mm 28.9 in	215 mm 8.5 in	430 mm 16.9 in	103 mm 4.1 in	45 / 46	11 / 12	12 / 13	13 / 14

Chart measurements taken with 3mm boot with sole
Fins could come labeled with EU and UK sizes only

Cressi's Size Chart is to be used as a reference only

GARA TURBO IMPULSE

NEW COLOR 2023

HIGH PERFORMANCE COMPACT FIN RAILS

Following the Impulse project we have successfully transferred the same design parameters for S-shaped undulating deformation to this innovative fin. This particular movement permits a notable accumulation of elastic potential energy in the blade, which is released in the return kick, transforming into thrust.

The thermoplastic rubber used for the water channelling rails is extremely flexible and soft so as not to undermine the intrinsic characteristics of the blade.

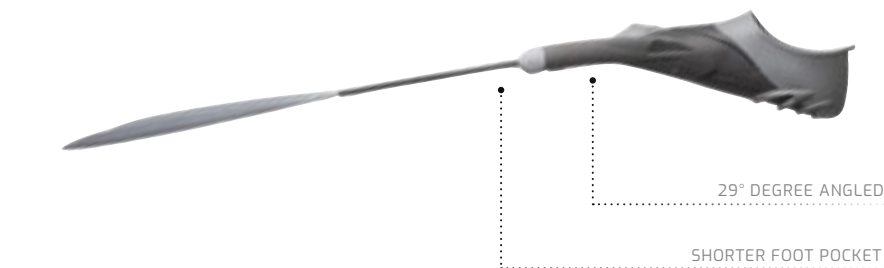

CODE	SIZE	CASE PACK
BH152036	Blue	36/37
BH152038	Blue	38/39
BH152040	Blue	40/41
BH152042	Blue	42/43
BH152044	Blue	44/45
BH152046	Blue	46/47
BH155036	Black	36/37
BH155038	Black	38/39
BH155040	Black	40/41
BH155042	Black	42/43
BH155044	Black	44/45
BH155046	Black	46/47



TECHNICAL FEATURES

- Extremely thin and light blade in compound made of elastomerized technopolymers developed by Cressi
- Stringer consisting of technopolymers with elastomeric loads with high flexural modulus
- Footpocket / blade angle of 29 degrees
- Modular detachable fin
- Superior performance
- Superior comfort
- Self adjusting foot pocket



INCLUDED GARA MODULAR INSOLE

- The new insole for Gara Modular fins is recommended for use with thin boots in temperate waters, because it improves the kick performance. The semi-rigid material of the insole is completely recycled. The insoles are supplied as a pair (right and left foot) and can be cut into their shape in three different sizes, according to pre-printed guidelines.
- Down-size Gara Fins foot pocket preformed sole
- Easily adjust size
- Non- corrosive plastic construction



WATER RAILS SYSTEM

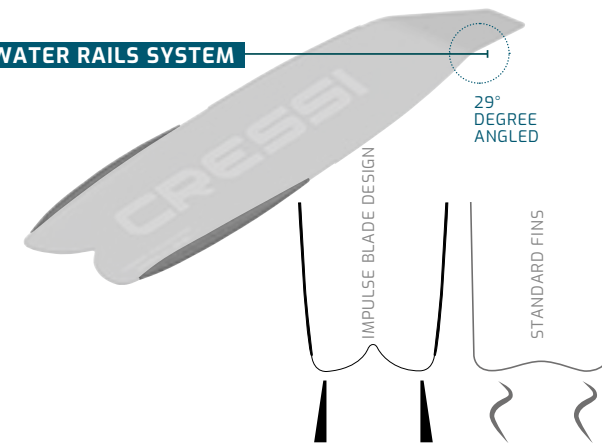

29° DEGREE ANGLED

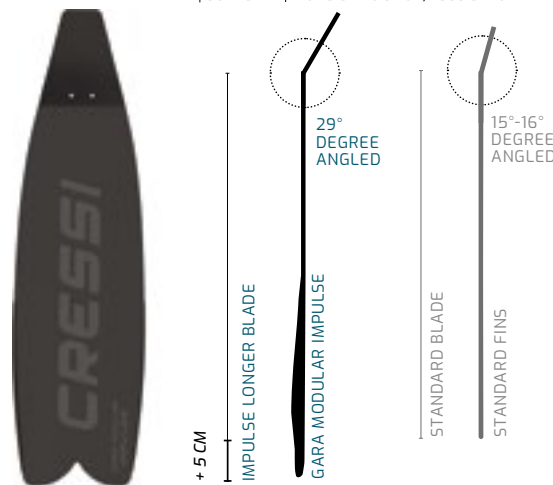

LIGHTER | 100% PROPULSIVE PERFORMANCE
SOFTER | MORE EFFICIENCY, LESS EFFORT

ACCESSORIES

CODE	PRODUCT
BZ175032	RUBBER FIN KEEPER (PAIR) - BLACK (S)
BZ175033	RUBBER FIN KEEPER (PAIR) - BLACK (M)
BZ175034	RUBBER FIN KEEPER (PAIR) - BLACK (L)
BZ180022	INSOLE FOR GARA FINS

SPARE PARTS

CODE	PRODUCT
BZ180020	GARA MODULAR ASSEMBLY KIT
BH015036	GARA MODULAR TURBO FOOT POCKET [36/37]
BH015038	GARA MODULAR TURBO FOOT POCKET [38/39]
BH015040	GARA MODULAR TURBO FOOT POCKET [40/41]
BH015042	GARA MODULAR TURBO FOOT POCKET [42/43]
BH015044	GARA MODULAR TURBO FOOT POCKET [44/45]
BH015046	GARA MODULAR TURBO FOOT POCKET [46/47]

FITSIZE

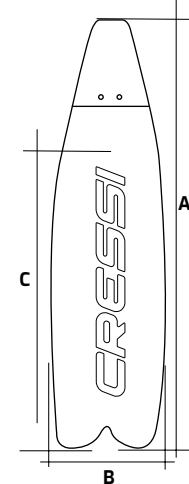
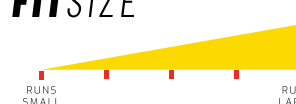

PRODUCT DIMENSION CHART

FIN SIZE	A LENGTH	B WIDTH	C BLADE	FIN HEIGHT FIT	SINGLE FIN WEIGHT
36/37	671 mm 26.4 in	215 mm 8.5 in	430 mm 16.9 in	83 mm 3.3 in	831 g 29.3 oz
37/38	683 mm 26.9 in	215 mm 8.5 in	430 mm 16.9 in	84 mm 3.3 in	856 g 30.2 oz
39/40	700 mm 27.6 in	215 mm 8.5 in	430 mm 16.9 in	87 mm 3.4 in	880 g 31.0 oz
41/42	712 mm 28.0 in	215 mm 8.5 in	430 mm 16.9 in	92 mm 3.6 in	928 g 32.7 oz
43/44	725 mm 28.5 in	215 mm 8.5 in	430 mm 16.9 in	97 mm 3.8 in	994 g 35.0 oz
45/46	734 mm 28.9 in	215 mm 8.5 in	430 mm 16.9 in	103 mm 4.1 in	1059 g 37.4 oz

SIZE CONVERSION CHART

EU FOOT SIZE	UK FOOT SIZE	US MEN'S FOOT SIZE	US WOMEN'S FOOT SIZE
36 / 37	3 / 4	4 / 5	5 / 6
37 / 38	5 / 6	6 / 7	7 / 8
39 / 40	6.5 / 7	7.5 / 8	8.5 / 9
41 / 42	8 / 9	9 / 10	10 / 11
43 / 44	10 / 10.5	11 / 11.5	12 / 12.5
45 / 46	11 / 12	12 / 13	13 / 14

Chart measurements taken with 3mm boot with sole
Fins could come labeled with EU and UK sizes only

Cressi's Size Chart is to be used as a reference only



GARA MODULAR IMPULSE

29 DEGREE ANGLED INTERCHANGEABLE BLADE

The Gara Modular system introduced by Cressi makes this a perfect choice for deep freediving and spearfishing for divers of all levels. The modular design lets the user replace / interchange blades for specific diving purposes, which make this the perfect fin to grow with, as the diver can change blades as their skills increase. Any standard Fiberglass or Carbon Fiber long blade will interchange in minutes without any modifications to either.



CODE	COLOR	SIZE	CASE PACK
BH092036	Blue	36/37	3
BH092038	Blue	38/39	3
BH092040	Blue	40/41	3
BH092042	Blue	42/43	3
BH092044	Blue	44/45	3
BH092046	Blue	46/47	3
BH093036	White	36/37	3
BH093038	White	38/39	3
BH093040	White	40/41	3
BH093042	White	42/43	3
BH093044	White	44/45	3
BH093046	White	46/47	3
BH095036	Black	36/37	3
BH095038	Black	38/39	3
BH095040	Black	40/41	3
BH095042	Black	42/43	3
BH095044	Black	44/45	3
BH095046	Black	46/47	3

ACCESSORIES

CODE	PRODUCT
BZ175032	RUBBER FIN KEEPER (PAIR) - BLACK (S)
BZ175033	RUBBER FIN KEEPER (PAIR) - BLACK (M)
BZ175034	RUBBER FIN KEEPER (PAIR) - BLACK (L)
BZ180022	INSOLE FOR GARA FINS

SPARE PARTS

CODE	PRODUCT
BZ180020	GARA MODULAR ASSEMBLY KIT
BH015036	GARA MODULAR TURBO FOOT POCKET (36/37)
BH015038	GARA MODULAR TURBO FOOT POCKET (38/39)
BH015040	GARA MODULAR TURBO FOOT POCKET (40/41)
BH015042	GARA MODULAR TURBO FOOT POCKET (42/43)
BH015044	GARA MODULAR TURBO FOOT POCKET (44/45)
BH015046	GARA MODULAR TURBO FOOT POCKET (46/47)



TECHNICAL FEATURES

- Interchangeable blade
- Superior performance
- Superior comfort
- Self adjusting foot pocket
- Thermoplastic rubber footpocket, certified Full Contact
- Standard blade / stringer interface with screws under the footpocket and side clips

- LIGHTER
- SOFTER
- 100% PROPULSIVE PERFORMANCE
- MORE EFFICIENCY
- LESS EFFORT

SELF ADJUSTING FOOT POCKET FOR A SUPERIOR COMFORT



IMPULSE BLADE DESIGN STANDARD FINS

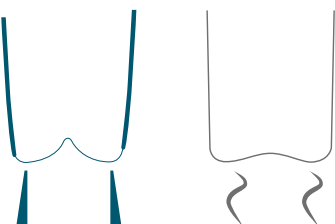

GARA MODULAR INSOLE



INCLUDED DOWN-SIZE GARA FINS FOOT POCKETS PERFORMED INSOLE EASILY ADJUST SIZE



GARA MODULAR

MINIMUM EFFORT >>> MAXIMUM POWER TRANSFER

The Gara Modular system makes this a perfect choice for deep freediving and spearfishing for divers of all levels. The modular design lets the user replace / interchange blades for specific diving purposes, which make this the perfect fin to grow with, as the diver can change blades as the divers skills increase. The self adjusting foot pocket is constructed with the most modern multi compound joining process to

deliver a foot pocket that can offer comfort and suppleness around the foot where desired and yet have stiffer compounds under the foot pocket and heel area where power transfer takes place. Can be comfortably worn with or without neoprene socks.



CODE	COLOR	SIZE
BH105136	Grey	36/37
BH105138	Grey	38/39
BH105140	Grey	40/41
BH105142	Grey	42/43
BH105144	Grey	44/45
BH105146	Grey	46/47

ACCESSORIES

CODE	PRODUCT
BZ175032	RUBBER FIN KEEPER (PAIR) - BLACK (S)
BZ175033	RUBBER FIN KEEPER (PAIR) - BLACK (M)
BZ175034	RUBBER FIN KEEPER (PAIR) - BLACK (L)
BZ180022	INSOLE FOR GARA FINS

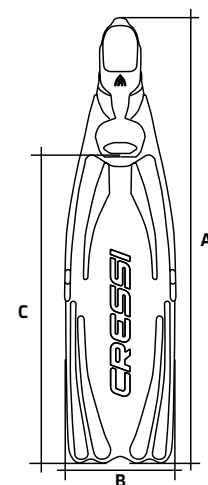

FIN SIZE	PRODUCT DIMENSION CHART			SINGLE FIN WEIGHT	SIZE CONVERSION CHART		
	A LENGTH	B WIDTH	C BLADE		EU FOOT SIZE	US MEN'S FOOT SIZE	US WOMEN'S FOOT SIZE
38/39	870 mm	215 mm	780 mm	990 g	38/39	7 / 8	8 / 9
40/41	880 mm	215 mm	780 mm	1050 g	40/41	8.5 / 9.5	9.5 / 10.5
42/43	900 mm	215 mm	780 mm	1100 g	w42/43	10 / 10.5	11 / 11.5
44/45	915 mm	215 mm	780 mm	1150 g	44/45	11 / 11.5	12 / 12.5
46/47	925 mm	215 mm	780 mm	1240 g	46/47	12 / 13	13 / 14

Chart measurements taken with 3mm boot with sole. Fins could come labeled with EU and UK sizes only.

TECHNICAL FEATURES

- Interchangeable blade
- Superior performance
- Superior comfort
- Self adjusting foot pocket
- Thermoplastic rubber footpocket, certified Full Contact
- Standard blade / stringer interface with screws under the footpocket and side clips

REGULAR STIFFNESS BLADE

INTERCHANGEABLE BLADE SELF ADJUSTING FOOT POCKET FOR A SUPERIOR COMFORT



GARA MODULAR INSOLE



INCLUDED DOWN-SIZE GARA FINS FOOT POCKETS PERFORMED INSOLE EASILY ADJUST SIZE



To maximize performance and comfort, wear fins with:

✓	✓	3 mm 5 mm 7 mm	3 mm 5 mm 7 mm
BARE FOOT	NEOPRENE SOCKS	NEOPRENE BOOTS	HARD SOLE BOOTS

Cressi's Size Chart is to be used as a reference only



GARA MODULAR SET

GARA PROFESSIONAL FINS + METIS MASK + CORSICA SNORKEL

Cressi made this set composed of professional items, of high quality and performance, to give the opportunity to use high-standard equipment for freediving and for spearfishing. The Modular system gives

the possibility to change the blades with more performing models. The mirrored lenses of the Metis mask increase the vibrance of the colors underwater and hide the eyes from fishes, not frightening them.



CODE	SIZE	CASE PACK
SE415036	36/37	3
SE415038	38/39	3
SE415040	40/41	3
SE415042	42/43	3
SE415044	44/45	3
SE415046	46/47	3



INTERCHANGEABLE BLADE



SELF ADJUSTING FOOT POCKET FOR A SUPERIOR COMFORT

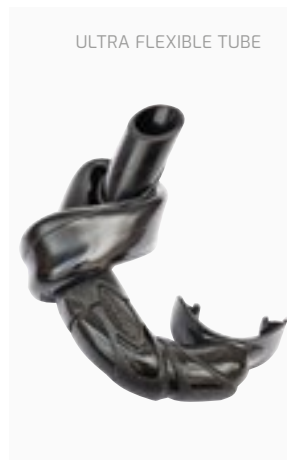

ULTRA FLEXIBLE TUBE

SPECIALIZED retailer product MADE IN ITALY

TECHNICAL FEATURES

- **FINS:**
 - Modular interchangeable blade system
 - Superior performance
 - Superior comfort
 - Self-adjusting foot pocket
 - Thermoplastic rubber foot pocket
- **MASK:**
 - Mirrored tempered glass lenses
 - Skirt in comfortable soft silicone
 - Wide adjustable buckles
- **SNORKEL:**
 - Soft bendable tube
 - Silicone mouthpiece



HD MIRRORED LENSES INCREASE THE VISION'S CLEARNESS BY 15%

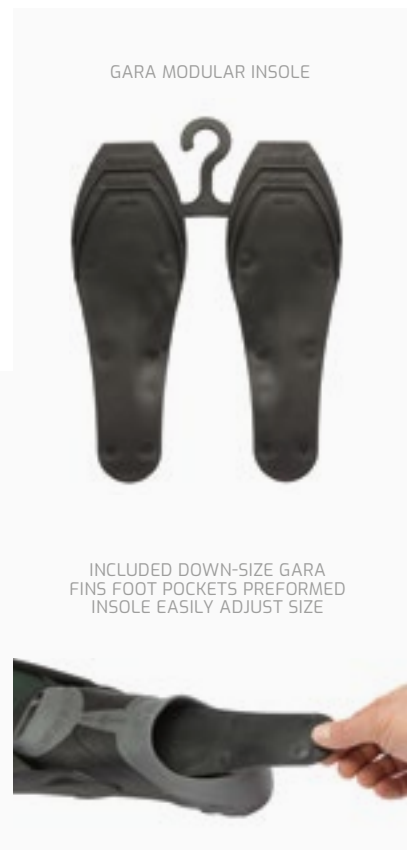

GARA MODULAR INSOLE

INCLUDED DOWN-SIZE GARA FINS FOOT POCKETS PREFORMED INSOLE EASILY ADJUST SIZE

GARA MODULAR FOOT POCKET SELF-ADJUSTING FOOT POCKET

CODE	SIZE	CASE PACK
BH005036	36/37	10
BH005038	38/39	10
BH005040	40/41	10
BH005042	42/43	10
BH005044	44/45	10
BH005046	46/47	10



GARA MODULAR TURBO FOOT POCKET SHORT SIDE RAILS FOOT POCKET

CODE	SIZE	CASE PACK
BH015036	36/37	10
BH015038	38/39	10
BH015040	40/41	10
BH015042	42/43	10
BH015044	44/45	10
BH015046	46/47	10



GARA MODULAR ASSEMBLY KIT

CODE
BZ180020



GARA MODULAR BLADES

MODULAR



BLACK

GREY

CODE	COLOR	STYLE	CASE PACK
BH055000	Black	Modular	3
BH055100	Grey	Modular	3

MODULAR IMPULSE



BLUE METAL

WHITE

BLACK

CARBON

CODE	COLOR	STYLE	CASE PACK
BH072000	Blue	Modular Impulse	10
BH073000	White	Modular Impulse	10
BH075000	Black	Modular Impulse	10
BH077000	Carbon	Modular Impulse	10



A percentage of the Cressi Gara Modular -Limited Special Edition-blades sales, will be donated for the shark conservation at One Ocean Water Inspired nonprofit organization.



LIMITED SPECIAL EDITION

OCEAN RAMSEY SHARKS EDITION



FINS THAT SAVE FINS

GARA MODULAR BLADE

Designed By Cressi Ambassadors: Ocean Ramsey and Juan Shark

CODE	PRODUCT
WBH059902	GARA MODULAR BLADE - OCEAN RAMSEY SHARKS EDITION



FRONT

BACK

BLADES MATERIAL MEDIUM COMPOSITE FIBERGLASS

The Composite Fibreglass is the world's most advanced composite diving fin blades. The customized hybrid epoxy resin system, coupled with state of the art design and aerospace grade fabric combine to create a fin that transfers the load to the larger muscle groups, instead of focusing on any one specific location. All the blades are hand made by DiveR in Australia and come with a 3-year warranty.

HOW-TO VIDEOS
 YouTube vimeo

GARA 3000 LD

LONG DISTANCE

The Gara 3000 LD is Cressi's entry-level long blade fin designed with softer blades, which makes the Gara 3000 a perfect choice for the beginning diver or those unexperienced with long-fin blades. The Gara 3000 is constructed with durability in mind and long soft plastic blades that can effectively transfer power with minimum effort.

This makes the fin comfortable and easy on the legs for beginners as well as during long duration dives.

The Gara 3000 is an extremely comfortable and is a full footpocket style fin. This fin is also constructed using Cressi's unique three material molding process, where

different compounds are bonded together to provide flexibility in the foot area, while being able to deliver power through the blade due to the stiffness the process provides. Can comfortably be worn with or without neoprene socks.



TECHNICAL FEATURES
• Durable construction designed to take abuse
• Soft long blade for ease of use
• Full footpocket for comfort
• Long blade for efficiency



CODE	SIZE	CASE PACK
BH135140	40/41	3
BH135142	42/43	3
BH135144	44/45	3
BH135146	46/47	3

CODE	PRODUCT
BZ175032	Rubber Fin Keeper (Pair) - Black (S)
BZ175033	Rubber Fin Keeper (Pair) - Black (M)
BZ175034	Rubber Fin Keeper (Pair) - Black (L)
BZ180022	Insole For Gara Fins

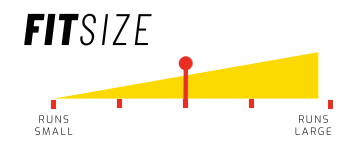
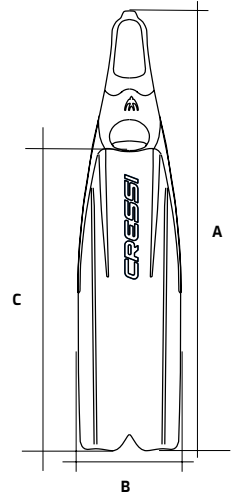

To maximize performance and comfort, wear fins with:

<input checked="" type="checkbox"/>	<input checked="" type="checkbox"/>	<input type="checkbox"/>	<input type="checkbox"/>
BARE FOOT	NEOPRENE SOCKS	NEOPRENE BOOTS (3mm, 5mm, 7mm)	HARD SOLE BOOTS (3mm, 5mm, 7mm)

FIN SIZE	PRODUCT DIMENSION CHART				SIZE CONVERSION CHART			
	A LENGTH	B WIDTH	C BLADE	SINGLE FIN WEIGHT	EU FOOT SIZE	UK FOOT SIZE	US MEN'S FOOT SIZE	US WOMEN'S FOOT SIZE
40/41	870 mm 24.3 in	210 mm 8.3 in	690 mm 27.2 in	861 g 1.89 lb	40/41	7 / 8	7.5 / 8.5	8.5 / 9.5
42/43	885 mm 34.9 in	210 mm 8.3 in	705 mm 27.8 in	952 g 2.09 lb	42/43	8 / 9	8.5 / 9.5	9.5 / 10.5
44/45	905 mm 35.7 in	215 mm 8.5 in	715 mm 28.2 in	984 g 2.16 lb	44/45	10 / 11	10.5 / 11.5	11.5 / 12.5
46/47	925 mm 36.5 in	220 mm 8.7 in	725 mm 28.6 in	1066 g 2.35 lb	46/47	12 / 13	12.5 / 13.5	13.5 / 14.5

Chart measurements taken with 3mm boot with sole. Fins could come labeled with EU and UK sizes only.

Cressi's Size Chart is to be used as a reference only

GARA 2000 HF

HIGH FREQUENCY



TECHNICAL FEATURES

- Stiff Long Blade designed for maximum depths
- Full footpocket for comfort
- Long blade for efficiency



Gara 2000 HF is an icon in the diving industry, and is the first fin in the industry to be manufactured using a three material molding process. Due to its lightweight and durability, it is an excellent choice for those looking for a fin that can provide the ultimate in performance while deep freediving and spearfishing, and those looking for obtaining maximum depths. The GARA 2000 has the stiffest blade in the CRESSI line and is

an extremely comfortable full footpocket style fin, with long firm blades with built in stringers and runners to effectively direct water flow down the blade aiding in efficiency. This fin is constructed using multiple compounds bonded together to provide comfort and suppleness in the foot area and strength and rigidity in the heel and blade area. Can comfortably be worn with or without neoprene socks.

CODE	SIZE	CASE PACK
BH115040	40/41	3
BH115042	42/43	3
BH115044	44/45	3
BH115046	46/47	3

ACCESSORIES

CODE	PRODUCT
BZ175032	RUBBER FIN KEEPER (PAIR) - BLACK (S)
BZ175033	RUBBER FIN KEEPER (PAIR) - BLACK (M)
BZ175034	RUBBER FIN KEEPER (PAIR) - BLACK (L)
BZ180022	INSOLE FOR GARA FINS

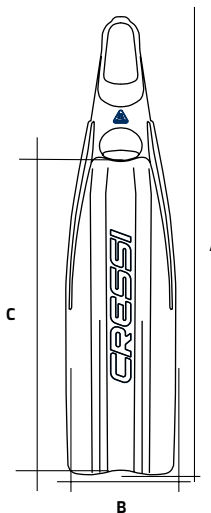

FIT SIZE



To maximize performance and comfort, wear fins with:

<input checked="" type="checkbox"/>	<input checked="" type="checkbox"/>	<input type="checkbox"/>	<input type="checkbox"/>
BARE FOOT	NEOPRENE SOCKS	NEOPRENE BOOTS 3 mm 5 mm 7 mm	HARD SOLE BOOTS 3 mm 5 mm 7 mm

FIN SIZE	PRODUCT DIMENSION CHART				SIZE CONVERSION CHART			
	A LENGTH	B WIDTH	C BLADE	SINGLE FIN WEIGHT	EU FOOT SIZE	UK FOOT SIZE	US MEN'S FOOT SIZE	US WOMEN'S FOOT SIZE
40/41	845 mm 33.3 in	215 mm 8.5 in	660 mm 26 in	790 g 1.74 lb	40/41	7 / 8	6.5 / 8	7.5 / 9
42/43	860 mm 33.9 in	215 mm 8.5 in	660 mm 26 in	895 g 1.97 lb	42/43	8 / 9	8 / 9.5	9 / 10.5
44/45	875 mm 34.4 in	220 mm 8.7 in	26.6 in 675 mm	970 g 2.13 lb	44/45	10 / 11	9.5 / 10.5	10.5 / 11.5
46/47	890 mm 35 in	223 mm 8.8 in	26.6 in 675 mm	1030 g 2.27 lb	46/47	12 / 13	11.5 / 12.5	12 / 13.5

Chart measurements taken with 3mm boot with sole
Fins could come labeled with EU and UK sizes only

Cressi's Size Chart is to be used as a reference only

GARA PROFESSIONAL LD

LONG DISTANCE



TECHNICAL FEATURES

- Firm blade designed to run over the footpocket for ease of use
- Full footpocket for comfort
- Thermo-Rubber soles for extra grip on wet surfaces
- Stiff long blade designed for maximum depths
- Full footpocket for comfort
- Long blade for efficiency



The Gara Professional LD is a high performance fin, requiring minimum effort to load the long blades. They are more forgiving than other long blade fins for untrained legs, making this an excellent choice for deep freedivers and spearfishers of all levels. They are ideal for long distance swimming, while ultimately providing the power and efficiency needed for deep freediving and spearfishing. Due to the multi

compound bonding process used during the manufacturing process, the Gara Pro LD is an exceptionally soft full footpocket style fin, which provides comfort during prolonged use on those long days in the water. Gara Pro LD delivers maximum power with minimum energy through its long firm blade that runs over the footpocket. Can comfortably be worn with or without neoprene socks.

CODE	COLOR	SIZE	CASE PACK
BH142040	Blue	40/41	3
BH142042	Blue	42/43	3
BH142044	Blue	44/45	3
BH142046	Blue	46/47	3
BH145140	Black	40/41	3
BH145142	Black	42/43	3
BH145144	Black	44/45	3
BH145146	Black	46/47	3

ACCESSORIES

CODE	PRODUCT
BZ175032	RUBBER FIN KEEPER (PAIR) - BLACK (S)
BZ175033	RUBBER FIN KEEPER (PAIR) - BLACK (M)
BZ175034	RUBBER FIN KEEPER (PAIR) - BLACK (L)
BZ180022	INSOLE FOR GARA FINS

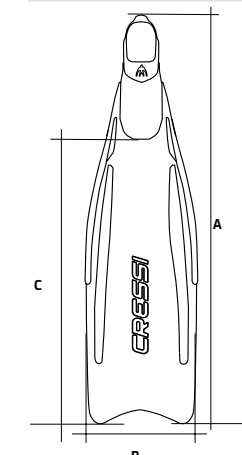

FIT SIZE



To maximize performance and comfort, wear fins with:

<input checked="" type="checkbox"/>	<input checked="" type="checkbox"/>	<input type="checkbox"/>	<input type="checkbox"/>
BARE FOOT	NEOPRENE SOCKS	NEOPRENE BOOTS 3 mm 5 mm 7 mm	HARD SOLE BOOTS 3 mm 5 mm 7 mm

FIN SIZE	PRODUCT DIMENSION CHART				SIZE CONVERSION CHART			
	A LENGTH	B WIDTH	C BLADE	SINGLE FIN WEIGHT	EU FOOT SIZE	UK FOOT SIZE	US MEN'S FOOT SIZE	US WOMEN'S FOOT SIZE
40/41	870 mm 34.3 in	220 mm 8.7 in	260 mm 10.3 in	861 g 1.89 lb	40/41	7 / 8	8 / 9	9 / 10
42/43	890 mm 35.1 in	225 mm 8.9 in	278 mm 11 in	952 g 2.09 lb	42/43	8 / 9	9 / 10	10 / 11
44/45	900 mm 35.5 in	233 mm 9.2 in	290 mm 11.4 in	984 g 2.16 lb	44/45	10 / 11	10.5 / 11.5	11.5 / 12.5
46/47	915 mm 36.1 in	242 mm 9.5 in	302 mm 11.9 in	1066 g 2.35 lb	46/47	12 / 13	12 / 13	13 / 14

Chart measurements taken with 3mm boot with sole
Fins could come labeled with EU and UK sizes only

Cressi's Size Chart is to be used as a reference only

GARA PROFESSIONAL SET 3.0

NEW COLOR 2023

GARA PROFESSIONAL LD FINS + METIS MASK + CORSICA SNORKEL

Cressi made this set composed by professional items, of high quality and performance, to give the opportunity to use a high standard equipment for freediving and for spearfishing.



CODE	COLOR	SIZE
SE401040	Black	40/41
SE401042	Black	42/43
SE401044	Black	44/45
SE401046	Black	46/47
SE402040	Blue	40/41
SE402042	Blue	42/43
SE402044	Blue	44/45
SE402046	Blue	46/47

LONG FINS SET BAG



METIS MASK

GARA PROFESSIONAL LD FINS

CORSICA SNORKEL



BLACK



BLUE

NEW COLOR 2023

RUBBER FIN KEEPER



The simple things in life often turn out to be the most useful and Fin Keepers are a perfect example. Their benefit is great especially if your foot pocket fits a little loose. They are a simple, inexpensive concept that works great, they last for years, yet rarely mentioned. Fin keepers keep the foot pocket tight against the heel giving the diver full fin power. You can't truly appreciate them until you use them.

When you do, you will notice the difference in power instantly. By holding the foot pocket against the bottom of the heel they limit or delete lost power. Without fin keepers every time you kick the fin the foot pocket will lift off your heel. Just a 1/4" of movement away from the heel will result in major power loss. Power is lost but spent energy is unchanged.

CODE	SIZE	CASE PACK
BZ175032	S	10
BZ175033	M	10
BZ175034	L	10





ULTRA LOW VOLUME | ERGONOMIC NOSE SHAPE | EASY COMPENSATION | FLEXIBLE BUCKLE | MICROMETRIC ADJUSTABLE BUCKLE | TEMPERED GLASS | 100% HIGH QUALITY SILICONE SKIRT

LOW INNER VOLUME MASK

MADE IN ITALY

TECHNICAL FEATURES

- Ultra low-volume mask, designed to facilitate the action of compensation
- Rigid co-stamped stiff core
- Ergonomic shape of the nose, design for facilitate the action of compensation
- Ideal for expert free-diver and spear-fisher

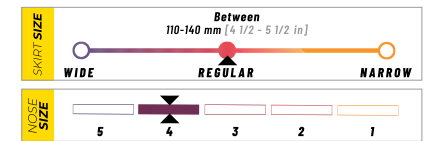
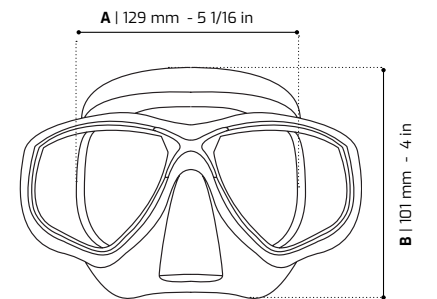

PROFILE VIEW

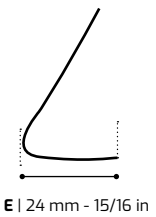

PRODUCT DIMENSION CHART (SKIRT SIZE)

A - WIDTH	B - HEIGHT	C - NOSE LENGTH	D - NOSE HEIGHT	E - NOSE WIDTH
129 mm	101 mm	33 mm	54 mm	24 mm
5 1/16 in	4 in	1 5/16 in	2 2/16 in	15/16 in

Cressi's Size Chart is to be used as a reference only



DOUBLE INJECTION SILICONE STRAP



ATOM

NEW 2023

ULTRA LOW VOLUME MASK

Atom is a radical mask, with incredible low internal volume, thought and built for freediving.

It is a frameless mask. Construction material has been reduced to the minimum.

Inside the silicon facial a stiff core is co-stamped with the two lenses, giving just the right rigidity to the mask.

This semi-rigid core substitutes the usual external plastic frame and allowed us to reduce the internal volume of the mask in an unseen way until today.

Another feature of Atom is the ergonomic shape of the nose.

Two small cavities, carved by the nostrils, facilitate the action of compensation. This makes the mask extremely stable during the dive. Atom will not move when you compensate pushing

Atom is the perfect mask for the expert free-diver and spear-fisher, who wants the maximum performance from its gear.



CODE	COLOR
D5522050	Blue Metal/Black
D5523050	White/Black
D5525050	Black/Black
D5525051	Black/Black-Mirrored Lens
D5527550	Green/Black

100% HIGH QUALITY SILICONE

SPECIALIZED retailer product

MADE IN ITALY



CALIBRO SF

PATENTED INNOVATIVE FOG STOP SYSTEM

Cressi's next generation diving masks are all equipped with the Integrated Dual Frame Technology which offers exceptional field of view, and the new Calibro is no exception.

The mask is designed so that the integrated face and frame allow for an extremely hydrodynamic and compact shape and a particularly wide lens, maintaining the mask extremely close to the face. Cressi's Calibro combines minimal internal volume with a phenomenal field of view due to the raked angle of the frame.

The buckles are, as always, directly integrated into the rigid skirt through a solid but flexible rubber attachment that allows you to adjust and place the mouthpiece without shifting the mask. Thanks to its matte coating the mask's components all match, enhancing the underwater experience since it prevents reflections in the water that may disturb marine life. Calibro is the perfect mask for freediving since it is designed to provide the diver with a feeling of total freedom and comfort.



CODE	COLOR	CASE PACK
D5425050	Black	6
D5429850	Green	6
D5426050	Black HD Edition	6

TECHNICAL FEATURES

- Ultra low volume
- Tempered glass
- Micrometric adjustable buckle
- Flexible buckle



HD MIRRORED LENSES INCREASE THE VISION'S CLEARNESS BY 15%

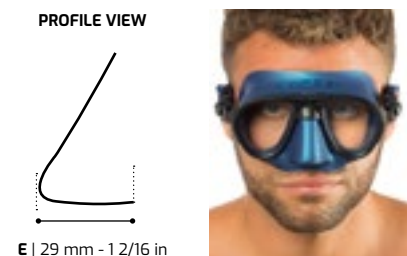
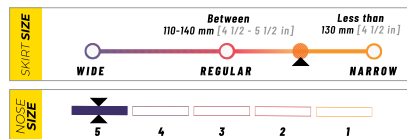
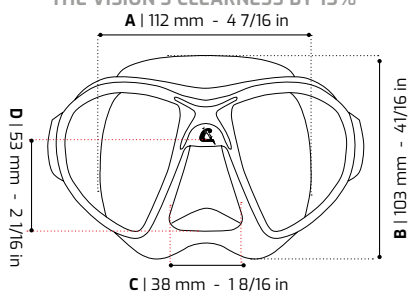

PRODUCT DIMENSION CHART (SKIRT SIZE)

A - WIDTH	B - HEIGHT	C - NOSE LENGTH	D - NOSE HEIGHT	E - NOSE WIDTH
112 mm 4 7/16 in	103 mm 4 1/16 in	38 mm 1 8/16 in	53 mm 2 1/16 in	29 mm 1 2/16 in

Cressi's Size Chart is to be used as a reference only



CRESSI PATENTED TECHNOLOGIES

★ **INCLINED GLASSES**
US 8281417 B1

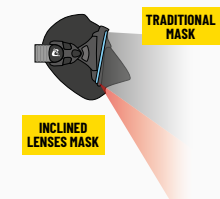

Cressi has developed and patented in 2001 a particular mask frame that to solve the problem of the divers not being able to easily see the scuba equipment. A scuba diver carrying many different pieces of equipment, some of them are vital like the pressure and depth gauges.

The solution has been found designing a new frame shape that is inclined downwards. Moreover, the shape of the lens is designed like an inverted teardrop increasing drastically the downward visibility.

★ **INTEGRATED BUCKLES**
US 8281417 B2

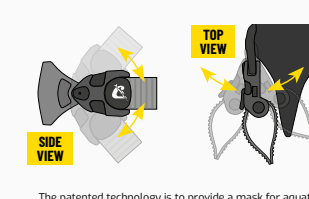

The patented technology is to provide a mask for aquatic activities that avoid loss of watertight during strap-tightening by a diver when the mask is in use underwater. The object of the invention is to avoid exertion of a tensile force or stress during mask adjustment and, in turn, rupture of the skirt. The buckles are not directly fixed to the frame but anchored to the rubber of the skirt, allowing it to freely swivel and pivot in all directions. The buckles are joined with lateral sides of the frame by brackets extending from the lateral sides. The brackets are made of a selected flexible material. This features facilitates the mask storage when not in use.

★ **INTEGRATED DUAL FRAME**
US 20140013494 A1

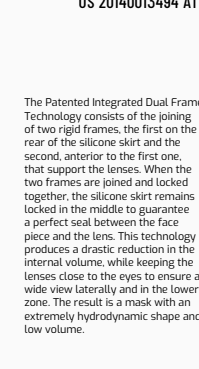

The Patented Integrated Dual Frame Technology consists of the joining of two rigid frames, the first on the rear of the silicone skirt and the second, anterior to the first one, that support the lenses. When the two frames are joined and locked together, the silicone skirt remains locked in the middle to guarantee a perfect seal between the face piece and the lens. This technology produces a drastic reduction in the internal volume, while keeping the lenses close to the eyes to ensure a wide view laterally and in the lower zone. The result is a mask with an extremely hydrodynamic shape and low volume.

★ **ANTI-FOG SYSTEM**
PATENT PENDING

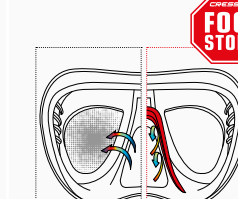

A patented membrane surrounding the inner nose pocket which acts as a barrier and traps any moisture escaping from the diver's nose involuntarily when breathing through the mouth. Not only is the moisture channeled away from the lenses, thus avoiding the fogging up of them, but it also reduces the need to compensate for pressure.

NANO

85 CM³: ULTRA LOW VOLUME

The Nano is for advanced divers, freediving and spearfishing lovers, designed to offer an extremely hydrodynamic and compact shape to help divers cut through the water and aid movements in small spaces. To develop the Nano mask, Cressi invented and patented the Integrated Dual Frame Technology System that joins the silicone skirt to the rigid frame lens without interruptions to

guarantee a perfect seal and drastically reduce the internal volume. It does not require intentional equalizing. The swiveling buckles feature micrometric regulation. The mask features inverted teardrop lenses slightly inclined made in tempered glass. An anatomical strap ensures a perfect seal on the head. Available with mirrored lenses to hide your eyes while attracting fish.



100% HIGH QUALITY SILICONE

SPECIALIZED retailer product

MADE IN ITALY

TECHNICAL FEATURES

- Double injection technology
- Flexible buckle



HD MIRRORED LENSES INCREASE THE VISION'S CLEARNESS BY 15%

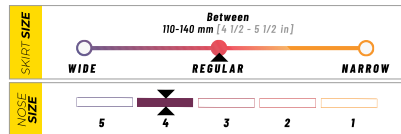
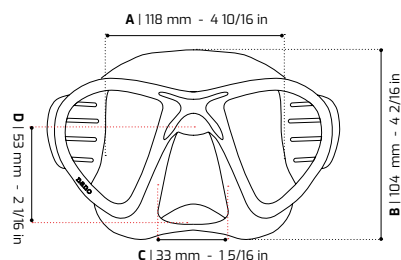

PROFILE VIEW

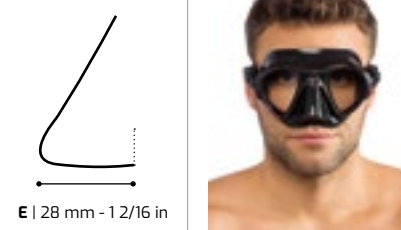

PRODUCT DIMENSION CHART (SKIRT SIZE)

A - WIDTH	B - HEIGHT	C - NOSE LENGTH	D - NOSE HEIGHT	E - NOSE WIDTH
118 mm	104 mm	33 mm	53 mm	28 mm
4 10/16 in	4 2/16 in	1 5/16 in	2 1/16 in	1 2/16 in

Cressi's Size Chart is to be used as a reference only
++ Measure ear to ear with a ruler



PACKAGING

CODE	COLOR	CASE PACK
DS365050	Black/Black	6
DS366050	Black/Black, HD Edition	6
DS369850	Green/Green	6

CODE	PRODUCT
DZ215002	SILICONE STRAP - SILVER for CRYSTAL MASKS
DZ215003	SILICONE STRAP - CLEAR for ITALIAN SCUBA MASK
DZ215004	SILICONE STRAP - BLACK for ITALIAN SCUBA MASK
DZ210021	BUCKLES - BLACK for AIR/BIG EYES EVO/EYES EVO/NANO/OCCHIO P.
DZ215009	STRAP LOOP SMALL for PRO DIVE MASKS - CLEAR (PAIR)
DZ215011	STRAP LOOP SMALL for PRO DIVE MASKS - BLACK (PAIR)

CRESSI PATENTED TECHNOLOGIES

★ INCLINED GLASSES
US 6272693 B1

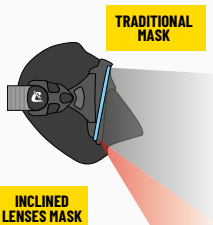

★ INTEGRATED BUCKLES
US 8281417 B2

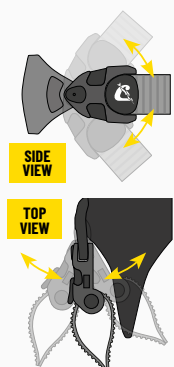

★ INTEGRATED DUAL FRAME
US 20140013494 A1



AIR

The Air mask has a particular tapered structure deriving directly from the highly popular Nano-mask patent. The Dual Integrated Frame Technology System joins the silicone skirt to the lens frame without major interruptions of the curvature continuity. The result is a mask with an extremely hydrodynamic shape and a significantly smaller size, with equal visibility. Thanks to the Inclined Lens Patented

Technology, the field of view obtained is particularly wide, laterally and in the lower zone. The skirt, in the front part, has a structural silicone insert which increases the sealing ability of the mask and creates an exceptionally pleasant chromatic play. Micrometer adjustable buckles.



CODE	COLOR	CASE PACK
DS405010	Black/Yellow	6
DS405050	Black/Black	6
DS405062	Black/Blue	6
DS405550	Blue Metal	6

CODE	PRODUCT
DZ215003	SILICONE STRAP - CLEAR for ITALIAN SCUBA MASK
DZ215004	SILICONE STRAP - BLACK for ITALIAN SCUBA MASK
DZ210021	BUCKLES - BLACK for AIR/BIG EYES EVO/EYES EVO/NANO/OCCHIO P.
DZ215009	STRAP LOOP SMALL for PRO DIVE MASKS - CLEAR (PAIR)
DZ215011	STRAP LOOP SMALL for PRO DIVE MASKS - BLACK (PAIR)

CRESSI PATENTED TECHNOLOGIES

★ INCLINED GLASSES
US 6272693 B1

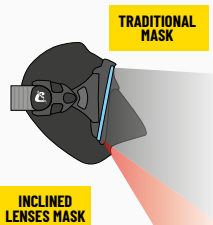

★ INTEGRATED BUCKLES
US 8281417 B2

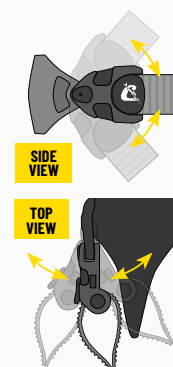

★ INTEGRATED DUAL FRAME
US 20140013494 A1



100% HIGH QUALITY SILICONE

MADE IN ITALY

TECHNICAL FEATURES

- Double injection technology
- Flexible buckle



HD MIRRORED LENSES INCREASE THE VISION'S CLEARNESS BY 15%

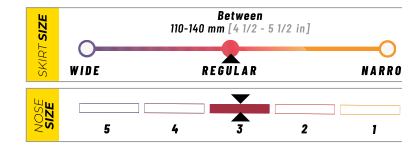
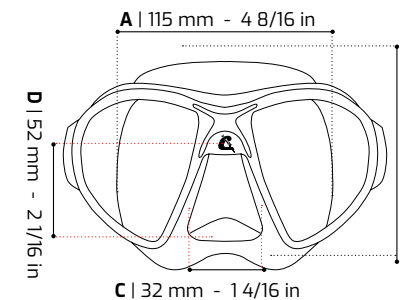

PROFILE VIEW

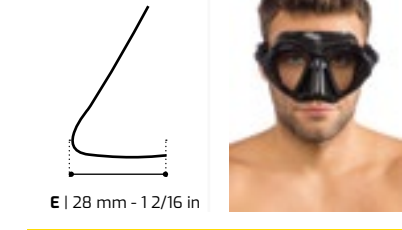

PRODUCT DIMENSION CHART (SKIRT SIZE)

A - WIDTH	B - HEIGHT	C - NOSE LENGTH	D - NOSE HEIGHT	E - NOSE WIDTH
115 mm	110 mm	32 mm	52 mm	28 mm
4 8/16 in	4 5/16 in	1 4/16 in	2 1/16 in	1 2/16 in

Cressi's Size Chart is to be used as a reference only
++ Measure ear to ear with a ruler



PACKAGING

BIG EYES EVOLUTION

The Big Eyes Evolution's signature inverted tear-drop lenses are raked inward and provide outstanding field of view with very low internal volume. A redesigned skirt now uses internal ribs to provide the ultimate in fit and support. Fully flexible, easy to adjust buckles are attached using Cressi's double injection molding technology for both comfort and extreme durability.



BLACK/BLACK

BLACK/BLACK LENS HD

CODE	COLOR	CASE PACK
D5336550	Black	6
D5336950	Black HD Edition	6

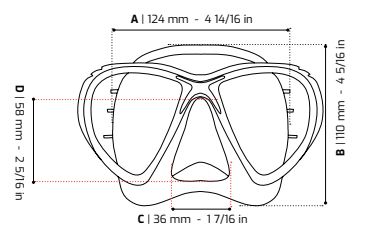

PROFILE VIEW

E | 29 mm - 1 2/16 in

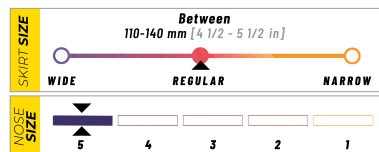

PRODUCT DIMENSION CHART (SKIRT SIZE)

A - WIDTH	B - HEIGHT	C - NOSE LENGTH	D - NOSE HEIGHT	E - NOSE WIDTH
124 mm 4 14/16 in	110 mm 4 5/16 in	36 mm 1 7/16 in	58 mm 2 5/16 in	29 mm 1 2/16 in

Cressi's Size Chart is to be used as a reference only
++ Measure ear to ear with a ruler

CRESSI PATENTED TECHNOLOGIES

★ **INCLINED GLASSES**
US 6272693 B1

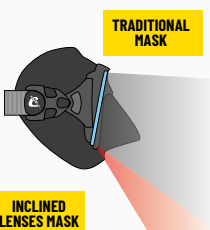

★ **INTEGRATED BUCKLES**
US 8281417 B2

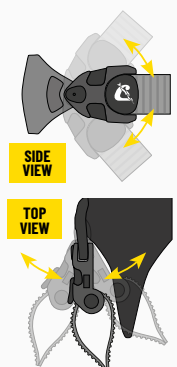

★ **INTEGRATED DUAL FRAME**
US 20140013494 A1



100% HIGH QUALITY SILICONE
MADE IN ITALY

TECHNICAL FEATURES

- Double injection technology
- Raked lenses provide excellent field of view low internal volume allows for effortless clearing dual density silicone skirt flexes for a perfect seal along the face and full support around the frame.

OPTICAL LENSES POSSIBILITY OF MOUNTING OPTICAL LENSES

• CORRECTION -1.0 > -6.00



• BIFOCAL LENS - CORRECTION +1.0 > +3.0

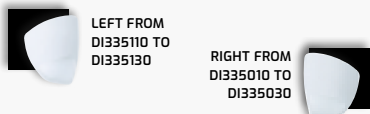

NOT SYMMETRICAL LENSES

- The lenses are available positive for correcting nearsightedness (**myopia**).
- The lenses are available with bifocal optics for corrective farsightedness (**hyperopia**).

OPTICAL LENSES INSTALLATION \$5.00

Complete information optical lenses
Please refer to page 156 chart

CODE	PRODUCT
D1335010	+1.0 (RIGHT) for BIG EYES EVO/QUANTUM
D1335015	+1.5 (RIGHT) for BIG EYES EVO/QUANTUM
D1335020	+2.0 (RIGHT) for BIG EYES EVO/QUANTUM
D1335025	+2.5 (RIGHT) for BIG EYES EVO/QUANTUM
D1335030	+3.0 (RIGHT) for BIG EYES EVO/QUANTUM
D1336010	-1.0 (RIGHT) for BIG EYES EVO/QUANTUM
D1336015	-1.5 (RIGHT) for BIG EYES EVO/QUANTUM
D1336020	-2.0 (RIGHT) for BIG EYES EVO/QUANTUM
D1336025	-2.5 (RIGHT) for BIG EYES EVO/QUANTUM
D1336030	-3.0 (RIGHT) for BIG EYES EVO/QUANTUM
D1336035	-3.5 (RIGHT) for BIG EYES EVO/QUANTUM
D1336040	-4.0 (RIGHT) for BIG EYES EVO/QUANTUM
D1336045	-4.5 (RIGHT) for BIG EYES EVO/QUANTUM
D1336050	-5.0 (RIGHT) for BIG EYES EVO/QUANTUM
D1336055	-5.5 (RIGHT) for BIG EYES EVO/QUANTUM
D1336060	-6.0 (RIGHT) for BIG EYES EVO/QUANTUM
D1335110	+1.0 (LEFT) for BIG EYES EVO/QUANTUM
D1335115	+1.5 (LEFT) for BIG EYES EVO/QUANTUM
D1335120	+2.0 (LEFT) for BIG EYES EVO/QUANTUM
D1335125	+2.5 (LEFT) for BIG EYES EVO/QUANTUM
D1335130	+3.0 (LEFT) for BIG EYES EVO/QUANTUM
D1336110	-1.0 (LEFT) for BIG EYES EVO/QUANTUM
D1336115	-1.5 (LEFT) for BIG EYES EVO/QUANTUM
D1336120	-2.0 (LEFT) for BIG EYES EVO/QUANTUM
D1336125	-2.5 (LEFT) for BIG EYES EVO/QUANTUM
D1336130	-3.0 (LEFT) for BIG EYES EVO/QUANTUM
D1336135	-3.5 (LEFT) for BIG EYES EVO/QUANTUM
D1336140	-4.0 (LEFT) for BIG EYES EVO/QUANTUM
D1336145	-4.5 (LEFT) for BIG EYES EVO/QUANTUM
D1336150	-5.0 (LEFT) for BIG EYES EVO/QUANTUM
D1336155	-5.5 (LEFT) for BIG EYES EVO/QUANTUM
D1336160	-6.0 (LEFT) for BIG EYES EVO/QUANTUM

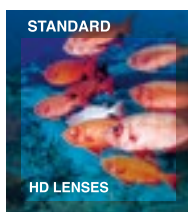

HD mirrored lenses increase the vision's clearness by 15%



PACKAGING

EYES EVOLUTION

The Eyes Evolution Crystal comes with all of the great features of the Big Eyes Evolution Crystal, but in a smaller size that makes it ideal for women and smaller faces. The Crystal Silicone is an exclusive

Cressi material that's so clear the mask's skirt is virtually invisible when diving.

The thickness of the mask frame has been reduced to such an extent that it is practically invisible when the mask is being worn.

CODE	COLOR	CASE PACK
D5355050	Black	6

CRESSI PATENTED TECHNOLOGIES

★ **INCLINED GLASSES**
US 6272693 B1

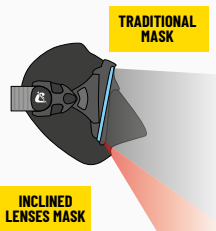

★ **INTEGRATED BUCKLES**
US 8281417 B2

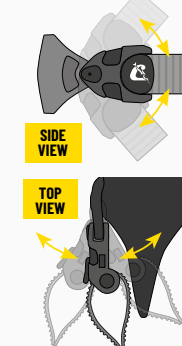

★ **INTEGRATED DUAL FRAME**
US 20140013494 A1



100% HIGH QUALITY SILICONE
MADE IN ITALY

TECHNICAL FEATURES

- Flexible buckle
- Designed for those with a narrow or small face



HD MIRRORED LENSES INCREASE THE VISION'S CLEARNESS BY 15%

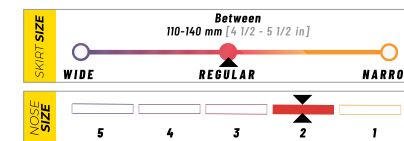
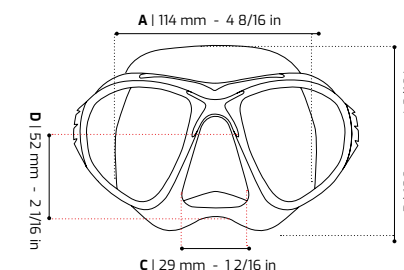

PROFILE VIEW

E | 28 mm - 1 2/16 in

PRODUCT DIMENSION CHART (SKIRT SIZE)

A - WIDTH	B - HEIGHT	C - NOSE LENGTH	D - NOSE HEIGHT	E - NOSE WIDTH
114 mm 4 8/16 in	106 mm 4 3/16 in	29 mm 1 2/16 in	52 mm 2 1/16 in	28 mm 1 2/16 in

Cressi's Size Chart is to be used as a reference only

PACKAGING



Z1

LOW VOLUME FRAMELESS MASK



Z1 is a frameless mask that boasts a low internal volume while offering a wide field of view in all directions.

The specific design uses the assembly of the silicone skirt directly over the single glass. This system guarantees great sturdiness and

a perfect watertight seal. The lower weight of the mask makes it ideal for travel. The flexible fit and reduced drag are appreciated for freediving and spearfishing, snorkeling and diving. The micrometrically adjustable buckles are comfortable and effective.



CODE	COLOR	CASE PACK
DN410000	Clear/Clear	30
DN410020	Blue/Blue	30
DN410050	Black/Black	30
DN410057	Graphite/Graphite	30
DN410080	Red/Red	30

100% HIGH QUALITY SOFT SILICONE BLACK SPECIALIZED retailer product

TECHNICAL FEATURES

- Low volume, single lens design for a wide field of view
- **Frameless:** silicone skirt bonds directly to the lens for lower weight and reduced drag
- Fast-adjust ratcheting strap buckles mounted to skirt
- High grade silicone seals
- Tempered glass lens
- Easy access nose pocket for equalization

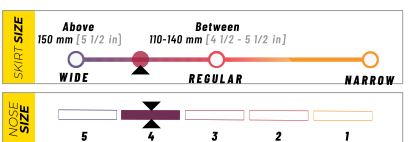
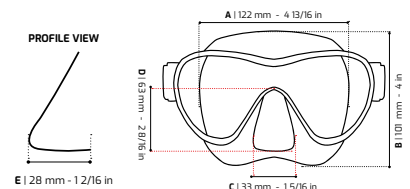

PRODUCT DIMENSION CHART (SKIRT SIZE)

A - WIDTH	B - HEIGHT	C - NOSE LENGTH	D - NOSE HEIGHT	E - NOSE WIDTH
122 mm	101 mm	33 mm	63 mm	28 mm
4 13/16 in	4 in	1 5/16 in	2 8/16 in	1 2/16 in

Cressi's Size Chart is to be used as a reference only

ZS1

SMALLER VERSION OF Z1 MASK



ZS1 is the Small version, suitable for adults with small faces, of the Z1, a frameless mask that boasts a low internal volume while offering a wide field of view in all directions. The specific design uses the assembly of the silicone skirt directly over the single glass. This system guarantees great sturdiness and

a perfect watertight seal. The lower weight of the mask makes it ideal for travel. The flexible fit and reduced drag are appreciated for freediving and spearfishing, snorkeling and diving. The micrometrically adjustable buckles are comfortable and effective.



CODE	COLOR	CASE PACK
DN420000	Clear/clear	30
DN422828	Turquoise/turquoise	30
DN423030	White/white	30
DN424545	Pink fluo/pink fluo	30
DN425050	Black/black	30

SPECIALIZED retailer product

TECHNICAL FEATURES

- Low-volume, single lens design for a wide field-of-view
- **Frameless:** silicone skirt bonds directly to the lens for lower weight and reduced drag
- Fast-adjust ratcheting strap buckles mounted to skirt
- High-grade silicone seals
- Tempered glass lens
- Easy-access nose pocket for equalization

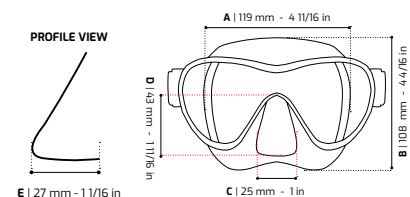

PRODUCT DIMENSION CHART (SKIRT SIZE)

A - WIDTH	B - HEIGHT	C - NOSE LENGTH	D - NOSE HEIGHT	E - NOSE WIDTH
119 mm	108 mm	25 mm	43 mm	27 mm
4 11/16 in	4 4/16 in	1 in	1 11/16 in	1 1/16 in

Cressi's Size Chart is to be used as a reference only

MATRIX

The compact twin-lens Matrix takes the basic design concepts of the Big Eyes Evolution and pushes them to a new level of performance.

More pronounced inverted tear-drop shaped lenses, raked inward to sit even closer to the eyes, and a more compact build overall make the Matrix an ideal choice for divers and freedivers looking for the biggest view in the smallest package.



CODE	COLOR	CASE PACK
DS302050	Black	6
DS309850	Green	6

100% HIGH QUALITY SILICONE MADE IN ITALY

TECHNICAL FEATURES

- Raked lenses provide excellent field-of-view
- Extremely low internal volume on par with the best freediving masks
- Silicone skirt shaped to provide a wide sealing surface for a leak-free fit
- Micrometric adjustable buckles allow precise headband adjustments
- Inverted tear-drop lenses improve downward vision for viewing your BCD while diving

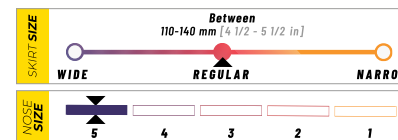
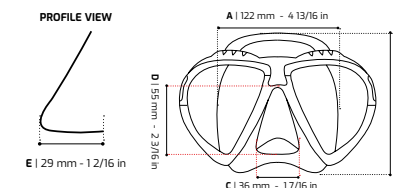

PRODUCT DIMENSION CHART (SKIRT SIZE)

A - WIDTH	B - HEIGHT	C - NOSE LENGTH	D - NOSE HEIGHT	E - NOSE WIDTH
122 mm	111 mm	36 mm	55 mm	29 mm
4 13/16 in	4 6/16 in	1 7/16 in	2 3/16 in	1 2/16 in

Cressi's Size Chart is to be used as a reference only

LINCE

A trimmed down version of the Matrix, the Lince is a perfect fit for many younger divers or those with narrower faces. The extremely low internal volume makes it

comfortable to wear and effortless to clear. Divers and snorkelers alike will appreciate the exceptional field of view offered in this ultra compact mask.

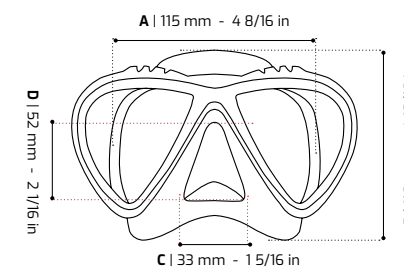

PROFILE VIEW

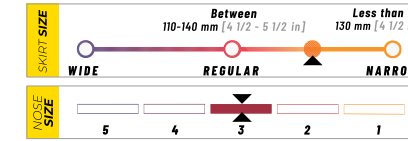
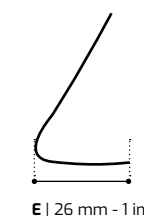

PRODUCT DIMENSION CHART (SKIRT SIZE)

A - WIDTH	B - HEIGHT	C - NOSE LENGTH	D - NOSE HEIGHT	E - NOSE WIDTH
115 mm	118 mm	33 mm	52 mm	26 mm
4 8/16 in	4 10/16 in	1 5/16 in	2 1/16 in	1 in

Cressi's Size Chart is to be used as a reference only



Ideal with snorkel
CORSICA
Hunter line

100% HIGH QUALITY SILICONE
EASY ADJUSTABLE BUCKLE
TEMPERED GLASS
100% HIGH QUALITY SILICONE SKIRT
MADE IN ITALY

TECHNICAL FEATURES

- Low internal volume
- Inverted teardrop lenses shape
- Very light



HD MIRRORED LENSES INCREASE THE VISION'S CLEARNESS BY 15%

METIS

The Metis is a two-window mask suitable for scuba diving and also for snorkeling. The skirt is completely made in high quality silicone, a more comfortable and long lasting material than the traditional plastic PVC. The silicone skirt allows to be fitted from different kinds of face shapes and ensure a perfect seal. Also the strap is made in silicone and it is large and wide behind the neck to ensure a tight fit and comfort. The length of the strap is easy to adjust thanks to the simple push of the wide buckles. You can choose different kind of lenses, colored or mirrored, to increase the

view underwater. All the lenses are made in tempered glass to ensure shatterproof and scratch resistance. The nose pocket is soft and easy to access used with only two fingers for proper equalization, also wearing gloves.

Special lenses edition are ideal per spearfishing and photographers. Yellow lenses increase the vibrancy of the colors and helps to see better the details in depth water. Available with Mirrored Lenses for hiding your eyes to the fishes.

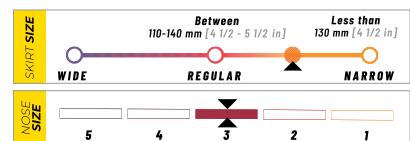
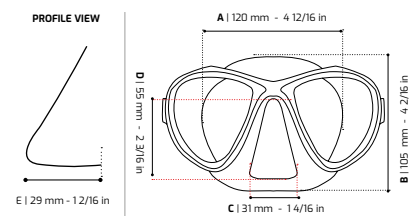

PRODUCT DIMENSION CHART (SKIRT SIZE)				
A - WIDTH	B - HEIGHT	C-NOSE LENGTH	D- NOSE HEIGHT	E-NOSE WIDTH
120 mm	105 mm	31 mm	55 mm	29 mm
4 12/16 in	4 2/16 in	1 4/16 in	2 3/16 in	1 2/16 in

Cressi's Size Chart is to be used as a reference only
++ Measure ear to ear with a ruler

CODE	COLOR	CASE PACK
US411010	BLACK/BLACK (YELLOW LENS)	10
US411050	BLACK/BLACK (MIRROR LENS)	10
US411223	BLUE HUNTER	10
US411253	BROWN HUNTER	10
US411293	GREEN HUNTER	10
US411500	BLACK/BLACK	10

SPARE PARTS	
CODE	PRODUCT
DZ222050	STRAP for SCUBA MASK TW - BLACK
DZ221050	BUCKLES for SCUBA MASK TW - BLACK/BLACK
DZ215012	STRAP LOOP for SCUBA MASK TW - BLACK (PAIR)

100% HIGH QUALITY SILICONE
EASY ADJUSTABLE BUCKLE
TEMPERED GLASS
100% HIGH QUALITY SILICONE SKIRT
MADE IN ITALY

TECHNICAL FEATURES

- Low internal volume allows for effortless clearing
- Lightweight, compact and rugged
- Ideal for travel or as a backup mask
- High-grade silicone skirt provides a leak-free seal
- Fixed quick-adjusting buckles



HD MIRRORED LENSES INCREASE THE VISION'S CLEARNESS BY 15%

FOCUS

The ultimate in versatility, this classic mask offers the best fit and performance for the greatest variety of facial shapes. Its low-volume, twin-lens design gives divers and snorkelers a proven combination of size,

fit and durability. Lightweight and easy-to-clear it has swiveling, quick-adjust buckles and accepts corrective lenses. It is also an excellent value.

CODE	COLOR	CASE PACK
DS242050	Black/Black	6

SPARE PARTS	
CODE	PRODUCT
DZ215006	SILICONE STRAP - BLACK for BIG EYES/FOCUS
DZ215013	STRAP LOOP LARGE for FOCUS/BIG EYES - BLACK (PAIR)

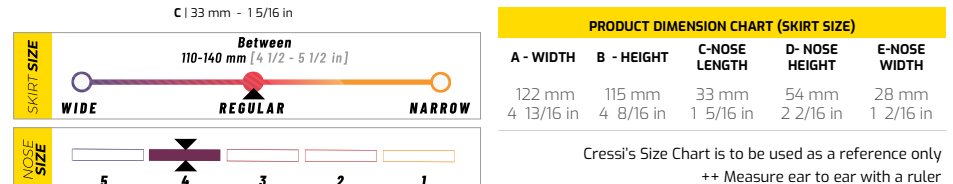
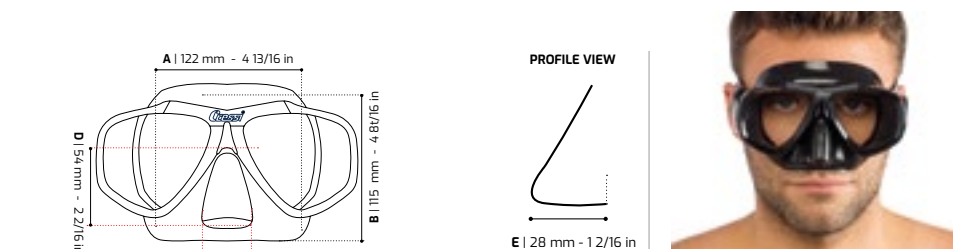

100% HIGH QUALITY SILICONE
EASY ADJUSTABLE BUCKLE
TEMPERED GLASS
100% HIGH QUALITY SILICONE SKIRT
MADE IN ITALY

TECHNICAL FEATURES

- Low internal volume allows for effortless clearing
- Lightweight, compact and rugged
- Ideal for travel or as a backup mask
- High-grade silicone skirt provides a leak-free seal
- Fixed quick-adjusting buckles

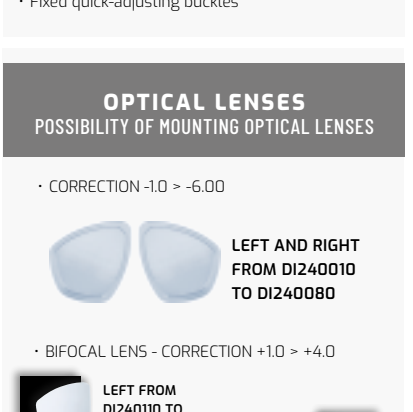

HD MIRRORED LENSES INCREASE THE VISION'S CLEARNESS BY 15%

FOCUS

The ultimate in versatility, this classic mask offers the best fit and performance for the greatest variety of facial shapes. Its low-volume, twin-lens design gives divers and snorkelers a proven combination of size,

fit and durability. Lightweight and easy-to-clear it has swiveling, quick-adjust buckles and accepts corrective lenses. It is also an excellent value.

CODE	COLOR	CASE PACK
DS242050	Black/Black	6

SPARE PARTS	
CODE	PRODUCT
DZ215006	SILICONE STRAP - BLACK for BIG EYES/FOCUS
DZ215013	STRAP LOOP LARGE for FOCUS/BIG EYES - BLACK (PAIR)

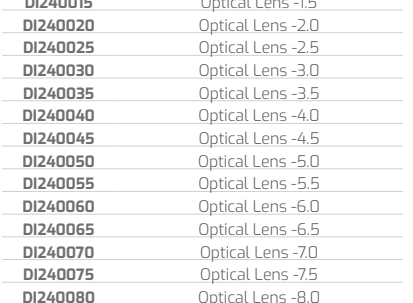
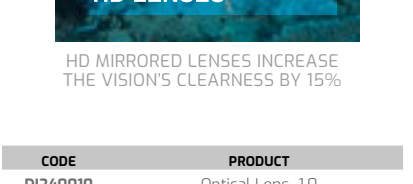

CODE	PRODUCT
D1240010	Optical Lens -1.0
D1240015	Optical Lens -1.5
D1240020	Optical Lens -2.0
D1240025	Optical Lens -2.5
D1240030	Optical Lens -3.0
D1240035	Optical Lens -3.5
D1240040	Optical Lens -4.0
D1240045	Optical Lens -4.5
D1240050	Optical Lens -5.0
D1240055	Optical Lens -5.5
D1240060	Optical Lens -6.0
D1240065	Optical Lens -6.5
D1240070	Optical Lens -7.0
D1240075	Optical Lens -7.5
D1240080	Optical Lens -8.0



SUPEROCCHIO

Superocchio is the grand classic in the Cressi line, it is still a favorite among many divers through its many years of availability. Superocchio is small, compact and provides low internal volume, which makes it a great choice for deep diving and spearfishing due to its low internal volume, which allows for minimal effort from the diver to comfortably equalize during descent.

The allergy free black silicone skirt protects the diver's eyes from unwanted back glare and distraction while spearing. The soft silicone mask strap comes with easy and quick adjusting buckles to help provide a comfortable precise fit and can be easily manageable even when wearing neoprene gloves.

CODE	COLOR	CASE PACK
DN234650	Black/Black	6

MINIMA

THE LOWEST VOLUME ON THE MARKET

This mask was designed specifically for deep sea diving, with innovative features that place it at the top of its category. The special reduced skirt, complete with a small seal ring, sticks like a suction cup to the face, leaving minimum air space inside the mask, which make compensation extremely easy, taking very little air from the lungs.

The lens-eye distance is the absolute smallest on the market and guarantees, even with small diameter lenses, excellent visibility in all directions. The two optic glass lenses are thicker than the standard to allow a special safety mould. The strap comes with instantly adjusting buckles for an easy and precise fit.

CODE	COLOR	CASE PACK
DS292050	Black/Black	6

100% HIGH QUALITY SILICONE MADE IN ITALY

TECHNICAL FEATURES

- Low internal volume
- Inverted teardrop lenses shape
- Very light



SPECIALIZED retailer product MADE IN ITALY

TECHNICAL FEATURES

- **Materials:** liquid silicone, hi-tech polymers
- **Strap buckles:** instant adjustment
- Internal very low volume
- **Dimensions of frame:** 168 x 45 mm
- **Weight:** 118 g



PACKAGING



PERLA

A mask particularly suitable for freediving and snorkeling, but just as appropriate for use in scuba diving.

It has separate lenses, a skirt edge fitting most of the faces and a small inner volume, perfect for freedivers.

It is made from soft transparent or dark silicone for a better comfort and a perfect seal. It comes with strong rapid action buckles to adjust the length strap.

CODE	COLOR	CASE PACK
DN208150	Black/Black	12
DN208198	Dark Green	12



TECHNICAL FEATURES

- Inverted teardrop inclined lenses for increased downwards visibility
- Skirt made in hypoallergenic quality silicone
- 2 tempered lens made in tempered glass
- Easy-to-use buckles for quickly strap length adjustment

100% HIGH QUALITY SILICONE MADE IN ITALY

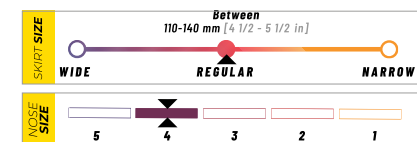
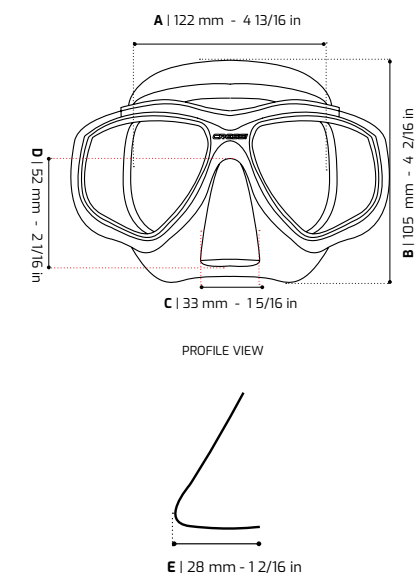

PRODUCT DIMENSION CHART (SKIRT SIZE)

A - WIDTH	B - HEIGHT	C - NOSE LENGTH	D - NOSE HEIGHT	E - NOSE WIDTH
122 mm	105 mm	33 mm	52 mm	28 mm
4 13/16 in	4 2/16 in	1 5/16 in	2 1/16 in	1 2/16 in

Cressi's Size Chart is to be used as a reference only

ALSO FOR RENTAL

TECHNICAL FEATURES

- Single lens in a classic retro oval shape
- Scratch resistant tempered glass for clarity and safety
- Rubber skirt and strap for great seal and comfort
- Easily adjustable buckles

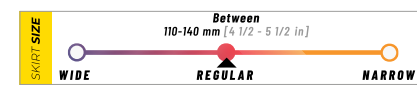
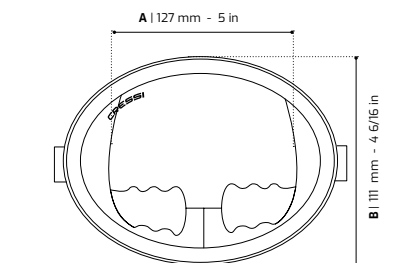

PRODUCT DIMENSION CHART (SKIRT SIZE)

A - WIDTH (mm)	B - HEIGHT (mm)	A - WIDTH (in)	B - HEIGHT (in)
127	111	5	4 6/16

Cressi's Size Chart is to be used as a reference only



PACIFICO

RUBBER MASK

CODE	CASE PACK
ZDN320050	10



CALIBRO & CORSICA

CALIBRO MASK + CORSICA SNORKEL



BLUE METAL

GREEN

BLACK

CODE	COLOR	CASE PACK
DS434550	Blue Metal	10
DS435050	Black	10
DS439850	Green	10

TECHNICAL FEATURES

- Designed specifically for Deep Freediving and Spearfishing
- Low internal volume allows the diver less effort to equalize
- Black allergy free silicone skirt to prevent back reflection
- Tempered glass lenses
- Easily adjustable mask strap and buckles
- Skirt design allows for fit of a multitude of face types



MADE IN ITALY

TECHNICAL FEATURES

- The multi-positional silicone soft mouthpiece provides extreme comfort during prolonged use
- Large diameter snorkel tube provides unobstructed ease of breathing
- Minimal tube and mouthpiece bends provides easier clearing capability

PERLA & MEXICO

PERLA MASK + MEXICO SNORKEL



CODE	COLOR	CASE PACK
DM102017	Black	10



ZS1 & CORSICA

ZS1 MASK + CORSICA SNORKEL

CODE	COLOR	CASE PACK
DM372828	Turquoise	10
DM374545	Pink Fluo	10

TECHNICAL FEATURES

MASK FEATURES:

- Single-lens design for a wide field-of-view
- Frameless technology
- Easy-access nose pocket for equalization
- Tempered glass lens CE certified
- Fast-adjust ratcheting strap buckles mounted to skirt
- Skirt made of high-grade soft silicone
- Smaller version for narrow faces

SNORKEL FEATURES:

- Anatomical hypoallergenic silicone mouthpiece provides extreme comfort during prolonged use
- Soft bendable snorkel tube to maintain proper and comfortable positioning
- Large diameter snorkel tube provides unobstructed ease of breathing
- Specially designed and molded u-bend provides easier clearing capability
- Ultra-flexible tube



PINK FLUO



TURQUOISE



CORSICA

Corsica is a highly technical snorkel designed specifically for deep freediving and spearfishing. The soft bendable large diameter tubing makes it extremely comfortable to properly position behind the head while maintaining ease of breathing on the surface. When diving, the mouthpiece tucks neatly under the chin for the ultimate in hydrodynamics. The anatomical hypoallergenic silicone mouthpiece provides extreme comfort during long duration in the water. The Corsica is available in either solid or camouflage color and is an excellent choice for the discriminating diver who is looking for the best equipment.

TECHNICAL FEATURES

- Anatomical hypoallergenic silicone mouthpiece provides extreme comfort during prolonged use
- Soft bendable Snorkel Tube to maintain proper and comfortable positioning
- Large diameter Snorkel Tube provides unobstructed ease of breathing
- Specially designed and molded U-Bend
- Provides easier clearing capability



ULTRA FLEXIBLE TUBE



BLUE HUNTER BROWN HUNTER GREEN HUNTER



TURQUOISE WHITE PINK FLUO BLUE METAL GREEN BLACK

CODE	COLOR	CASE PACK
EG268523	Camo Blue	12
EG268528	Turquoise	12
EG268530	White	12
EG268545	Pink Fluo	12
EG268550	Black/Black	12
EG268553	Camo Brown	12
EG268555	Blue	12
EG268593	Camo Green	12
EG268598	Green/Black	12

POLYBAG

CRESSI

www.cressi.com

AMERICA



CODE	CASE PACK
EG267050	12

TECHNICAL FEATURES

- The multi-positional silicone soft mouthpiece provides extreme comfort during prolonged use
- Large diameter Snorkel Tube provides unobstructed ease of breathing
- Minimal tube and mouthpiece bends provides easier clearing capability

CRESSI

www.cressi.com

POLYBAG

GRINGO



CODE	CASE PACK
EG266000	12

TECHNICAL FEATURES

- The multi-positional silicone soft mouthpiece provides extreme comfort during prolonged use
- Large diameter Snorkel Tube provides unobstructed ease of breathing
- Minimal tube and mouthpiece bends provides easier clearing capability

CRESSI

www.cressi.com

POLYBAG



7-12° C
44.6-53.6° F
CE CERTIFICATION
DIVING WETSUIT
EN 14225-1:2017: A

8mm



FISTERRA

TWO-PIECE WETSUIT 8 MM

SPECIALIZED
retailer product

TECHNICAL FEATURES

- Two-piece wetsuit
- Ultra durable neoprene

JACKET WITHOUT ZIPPERS
HIGH TROUSERS



X-PLUSH ELASTIC TERRY LOOP



ELASTIC
PLUSH INSIDE



Robust wetsuit also ideal for commercial fishing. Fisterra was originally born in version 8mm, to respond to the need of professional divers in cold waters. The demand for professional divers, diving instructors and users who demand maximum thermal performance and comfort has encouraged us to incorporate a 5 mm version for temperate waters into the collection.

Fisterra 5 mm is a resistant, very watertight and highly thermal combination with jacket without zippers and high trousers with dungarees. A combination that combines,

therefore, characteristics that place it at the apex of pure performance in a wetsuit of this thickness. Low-compression LC neoprene that guarantees optimum thermal protection at the bottom due to its high resistance to compression ideal for professional work or long duration diving. Nylon outer lining of high weight very resistant, interior X-Plush elastic terry loop, waterproof and great sliding that facilitates the placement and removal of the suit at the same time has a large thermal memory. Wide anti-abrasion knee-spin pads and elbow pads in Supratex®.

CODE	SIZE	CASE PACK
LK489502	S	5
LK489503	M	5
LK489504	L	5
LK489505	XL	5
LK489506	2XL	5
LK489507	3XL	5

16-24° C
60.8-75.2° F
CE CERTIFICATION
DIVING WETSUIT
EN 14225-1:2017: C

3 mm

10-18° C
50-64.4° F
CE CERTIFICATION
DIVING WETSUIT
EN 14225-1:2017: B

5 mm

LAMPUGA

TWO-PIECE WETSUIT



Inspired by the livery of the pelagic fish. A special digital printing system has been used for this new camouflage wetsuit, allowing high resolution images to be obtained and thus create an exclusive camouflage design. The new "Cryptic Camouflage Technology" of Cressi is based

on a real image of a fish (a dolphin fish in this case, with its dominant colours), to create camouflage that is very close to the original and then altered to obtain a repetitive effect that is one of a kind. The materials used are: high elastic camo on the outside, open-cell neoprene on the inside.

3 mm

CODE	SIZE	CASE PACK
LU490112	S	5
LU490113	M	5
LU490114	L	5
LU490115	XL	5
LU490116	2XL	5
LU490117	3XL	5

5 mm

CODE	SIZE	CASE PACK
LU490102	S	5
LU490103	M	5
LU490104	L	5
LU490105	XL	5
LU490106	2XL	5

ULTRASOFT NEOPRENE

SPECIALIZED retailer product

TECHNICAL FEATURES

- Preformed anatomical cut
- Jacket with padded reinforcement on the chest
- Watertight seals in smooth skin on hood, wrists and ankles
- Reinforced anti-abrasion lining on the chest and knees
- High-waisted trousers with watertight seals on the ankles and waist

SMOOTH SKIN WATERTIGHT SEALS



CHEST REINFORCEMENT



AQUA STOP SYSTEM

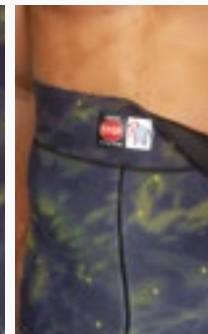

PROTECTIVE REINFORCEMENT



SINGLE PIECE UNDERARM SECTION



16-24° C
60.8-75.2° F
CE CERTIFICATION
DIVING WETSUIT
EN 14225-1:2017: C

5 mm

10-18° C
50-64.4° F
CE CERTIFICATION
DIVING WETSUIT
EN 14225-1:2017: B

7 mm

SEPPIA

TWO-PIECE WETSUIT



When wet changes colour accentuating mimetism!

Wetsuit created with the exclusive new Cressi green/brown camouflage, computer-designed to make it more difficult for prey to create solid images, thereby confusing the wearer with the background.

5 mm

CODE	SIZE	CASE PACK
XLE468502	S	5
XLE468503	M	5
XLE468504	L	5
XLE468505	XL	5
XLE468506	2XL	5

7 mm

CODE	SIZE	CASE PACK
XLE468702	S	5
XLE468703	M	5
XLE468704	L	5
XLE468705	XL	5
XLE468706	2XL	5

SMOOTH SKIN WATERTIGHT SEALS



KNEEPAD

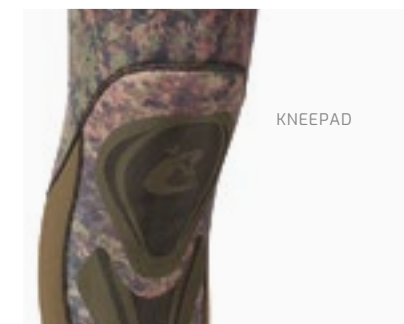

CHEST REINFORCEMENT



PROTECTIVE REINFORCEMENT



SINGLE PIECE UNDERARM SECTION



>22° C / >71.6° F
 CE CERTIFICATION DIVING WETSUIT EN 14225-1:2017: D
 3.5 mm
 16-24° C / 60.8-75.2° F
 CE CERTIFICATION DIVING WETSUIT EN 14225-1:2017: B
 5 mm
 10-18° C / 50-64.4° F
 CE CERTIFICATION DIVING WETSUIT EN 14225-1:2017: B
 7 mm

SPECIALIZED retailer product

APNEA

TWO-PIECE WETSUIT



A well-cut suit with particular attention to comfort around the areas where the body suffers most friction. Internal layer in metallic black and a thickness of 3.5 mm and 5 mm.

3.5 mm

CODE	SIZE	CASE PACK
LE450102	S	5
LE450103	M	5
LE450104	L	5
LE450105	XL	5
LE450106	2XL	5
LE450107	3XL	5

5 mm

CODE	SIZE	CASE PACK
LE450202	S	5
LE450203	M	5
LE450204	L	5
LE450205	XL	5
LE450206	2XL	5
LE450207	3XL	5

7 mm

CODE	SIZE	CASE PACK
LE450302	S	5
LE450303	M	5
LE450304	L	5
LE450305	XL	5
LE450306	2XL	5
LE450307	3XL	5

TECHNICAL FEATURES

- Made of black-metallite Neoprene
- Chest reinforcement
- Knee pads
- Interior in open cell Neoprene



PROTECTIVE REINFORCEMENT



CHEST REINFORCEMENT



KNEEPAD



TOKUGAWA

2-PIECE WITH HOOD



The Tokugawa wetsuit is an excellent spearfishing and freediving wetsuit. It was designed by the Cressi Australia team, with the knowledge and help of the Italian Cressi family, based on the market-leading Apnea wetsuit pattern. It was designed specifically for use in blue waters as a perfect hardwearing spearfishing and pool training suit. The unique camouflage adapts to different water environments – from

OPEN CELL 3.5 mm

CODE	SIZE	CASE PACK
LU490022	S	5
LU490023	M	5
LU490024	L	5
LU490025	XL	5
LU490026	2XL	5
LU490027	3XL	5

NYLON CLOSED CELL 2 mm

CODE	SIZE	CASE PACK
LU490032	S	5
LU490033	M	5
LU490034	L	5
LU490035	XL	5
LU490036	2XL	5
LU490037	3XL	5

TECHNICAL FEATURES

- Blue camouflage pattern
- Anatomical cuts
- Chest loading pads
- Knee pads
- Interior reinforced with Nylon



the blue waters of the Caribbean Sea to the greener tones of the Northern USA. It is manufactured with flexible, comfortable, soft neoprene. This material is designed for flexibility.

This wetsuit is named in honor of the Tokugawa shogunate – The Tokugawa shogunate was the last feudal Japanese military government, which existed between 1600 and 1868.

TOKUGAWA

MONOPIECE WETSUIT



Designed for blue water spearfishing Tokugawa, named after the Japanese feudal shogunate, is a one-piece 3 mm thick wetsuit, perfect for spearfishing, freediving and swimming, as well as for open water and pool training. The unique camouflage of this wetsuit is appropriate for different aquatic environments, from the blue waters of the Caribbean Sea to the greener tones of North American waters. The wetsuit's graphics provide the ultimate in camouflage

for all environments. Tokugawa, which is made of elastic, flexible, comfortable and of neoprene, has an anatomically designed cut specific to Cressi wetsuits, with preformed arms and legs that improve wearability and movement in the water.

The chest and the knee pad reinforcements are designed specifically for spearfishing.

The Dura Stretch nylon lining improves the wetsuit's elasticity, comfort and durability.

3 mm

CODE	SIZE	CASE PACK
LU490002	S	10
LU490003	M	10
LU490004	L	10
LU490005	XL	10
LU490006	2XL	10
LU490007	3XL	10

TECHNICAL FEATURES

- For spearfishing, freediving camouflage design
- Rear zipper



CHEST REINFORCEMENT



KNEEPAD



COBIA

EXTRA WARMTH TOP RASHGUARD

> 26° C / 80° F

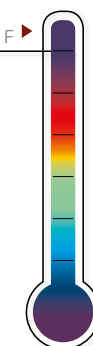

SUGGESTED WATER TEMPERATURE

TECHNICAL FEATURES

- Chest in quality Neoprene 1mm
- Hood and sleeves made of rash guard fabric
- Wearable under wetsuit
- Excellent anatomic cuts
- Available in Cressi's mimetic pattern blue or green



NEOPRENE CHEST CHEST PAD



SMOOTH SKIN WATERTIGHT SEALS



The Cobia is the ultimate rash guard that features a chest area completely made in 1 mm premium Neoprene to provide extra warmth. It's hooded to give the opportunity to protect and to heat also the head.

The Cobia can be worn under a wetsuit to give more warmth and protection. Can be used in any water sports, from windsurfing to scuba diving.

BLUE

CODE	COLOR	SIZE	CASE PACK
USW011102B	Camo Blue	S	10
USW011103B	Camo Blue	M	10
USW011104B	Camo Blue	L	10
USW011105B	Camo Blue	XL	10
USW011106B	Camo Blue	2XL	10
USW011107B	Camo Blue	3XL	10

GREEN

CODE	COLOR	SIZE	CASE PACK
USW011202G	Camo Green	S	10
USW011203G	Camo Green	M	10
USW011204G	Camo Green	L	10
USW011205G	Camo Green	XL	10
USW011206G	Camo Green	2XL	10
USW011207G	Camo Green	3XL	10

HUNTER RASH GUARD

LOADING CHEST PAD

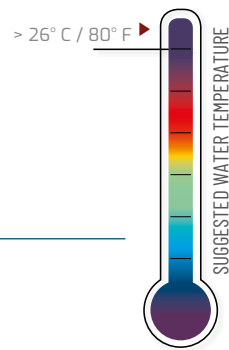

TECHNICAL FEATURES

- Camo patterns for blue water and reef environments
- Excellent anatomical cuts
- UPF U/V rays protection



CHEST PAD

The Hunter is a rash guard made with strong and elastic synthetic fabric. Made with anatomical cuts and can be worn in any water sports. Protects from wind and from UPF Ultraviolet rays. The chest is seamless

and features a soft durable pad that protects the body. Can be worn over a wetsuit that does not have chest loading pad. Available in Cressi's mimetic patterns.

BLUE

CODE	COLOR	SIZE	CASE PACK
USW010102B	Camo Blue	S	5
USW010103B	Camo Blue	M	5
USW010104B	Camo Blue	L	5
USW010105B	Camo Blue	XL	5
USW010106B	Camo Blue	2XL	5
USW010107B	Camo Blue	3XL	5

GREEN

CODE	COLOR	SIZE	CASE PACK
USW010202G	Camo Green	S	5
USW010203G	Camo Green	M	5
USW010204G	Camo Green	L	5
USW010205G	Camo Green	XL	5
USW010206G	Camo Green	2XL	5
USW010207G	Camo Green	3XL	5



HEX GRIP

Cressi designed a glove that provides high comfort and dexterity while being cut puncture and impact-resistant, making it ideal for Lobstering and Spearfishing. The wrist closer will always keep the glove in place, regardless of normal use expansion from water weight.

LIME

CODE	SIZE	CASE PACK
PQ100607	XS	10
PQ100608	S	10
PQ100609	M	10
PQ100610	L	10
PQ100611	XL	10
PQ100612	2XL	10

BLUE

CODE	SIZE	CASE PACK
PQ100601	XS	10
PQ100602	S	10
PQ100603	M	10
PQ100604	L	10
PQ100605	XL	10
PQ100606	2XL	10



CONCH DYFIBER

Cressi designed a glove that provides high comfort and dexterity while being cut and puncture resistant, making it ideal for Lobstering and Spearfishing. The wrist closer will always keep the glove in place, regardless of normal use expansion from water weight.

LIME

CODE	SIZE	CASE PACK
PQ100707	XS	10
PQ100708	S	10
PQ100709	M	10
PQ100710	L	10
PQ100711	XL	10
PQ100712	2XL	10

BLUE

CODE	SIZE	CASE PACK
PQ100701	XS	10
PQ100702	S	10
PQ100703	M	10
PQ100704	L	10
PQ100705	XL	10
PQ100706	2XL	10



HUNTER GLOVES

The Hunter Gloves are 5 fingers gloves made with premium quality Elastic Neoprene. This fabric provides high elasticity and comfort giving the possibility to use the complete movements of the fingers.

CAMO BLUE | 2mm

CODE	SIZE
USW022501	S
USW022502	M
USW022503	L
USW022504	XL

CAMO GREEN | 2mm

CODE	SIZE
LX477901	S
LX477902	M
LX477903	L
LX477904	XL



TECHNICAL FEATURES

- Cressi's glove materials offer maximum strength with minimum weight.
- High-performance polyethylene and stainless steel
- The sandy nitrile palm provides outstanding grip in dry, wet, and oily conditions.

4 CUT RESISTANCE LEVEL
3 PUNCTURE RESISTANCE LEVEL

HUNTER SOCKS

3 mm

Very soft and super supple socks made of 3 mm Elastic-Span neoprene. They have a honeycomb reinforcing and anti-slip coating on the sole. The Black-Metallite lining makes them easier to put on.

SIZE CONVERSION CHART			
SIZE	EU FOOT SIZE	US MEN'S FOOT SIZE	US WOMEN'S FOOT SIZE
S	36 / 38	5 / 6.5	6 / 7.5
M	39 / 40	7 / 8	8 / 9
L	41 / 43	9 / 10.5	10 / 11.5
XL	44 / 46	11 / 12.5	12 / 13.5



CAMO BLUE

CODE	SIZE	CASE PACK
USW020201	S	5
USW020202	M	5
USW020203	L	5
USW020204	XL	5

CAMO GREEN

CODE	SIZE	CASE PACK
LX433211	S	5
LX433212	M	5
LX433213	L	5
LX433214	XL	5



POLYBAG

ANTI-SLIP SOCKS

2.5 MM

These are single-lined, thin, high stretch neoprene socks. The inner is lined in Metallite so they are easy to put on. The sole has an effective non-slip lining. They can be used with both closed foot fins for greater warmth and to protect the skin from scratches and chafing, as well as with firm-soled socks, using open-heel fins. In this case, warmth is considerably increased and it is also easier to put on your wetsuit.

SIZE CONVERSION CHART			
SIZE	EU FOOT SIZE	US MEN'S FOOT SIZE	US WOMEN'S FOOT SIZE
S	36 / 38	5 / 6.5	6 / 7.5
M	39 / 40	7 / 8	8 / 9
L	41 / 43	9 / 10.5	10 / 11.5
XL	44 / 46	11 / 12.5	12 / 13.5

CODE	SIZE	CASE PACK
LX433001	S	10
LX433002	M	10
LX433003	L	10
LX433004	XL	10



CRESSI USA FIT SIZE

Runs Small

Runs Large



FREEDIVING TRAINING BUOY

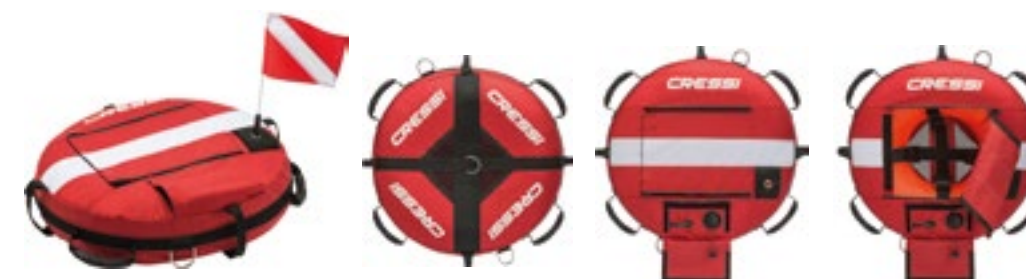

TECHNICAL FEATURES

- Outer bag made of 1050 Denier Cordura fabric
- Inner bladder with inflator valve
- 4 TPR lateral handles
- 2 lateral stainless steel D-rings
- Underneath central large stainless steel D-ring for rope connection
- Large storage compartment with Velcro closure

Dedicated to freediving lovers. It has a durable external material, an external zipper pocket, 4 external handles for pre-immersion preparation, and 2 exterior D-rings. The wide interior space allows storing the rope during transport. The inner bladder features a

valve offering the choice of oral inflation or the use of an inflator hose. The freediving rope can be connected to the underneath stainless steel D-ring. The red diving flag is included to be seen from distance. Made of durable 1050 Denier Cordura fabric.

CODE

TA611990

TORPEDO PRO BUOY FLOAT



CODE

TA611603

SIGNAL BOARD BUOY

NEW 2023



CODE

TA611902

HUNTER SWIVEL SNAP CLIP



DESCRIPTION:

The Snap Clip is made in stainless steel to ensure strength. It features a swivel to be knotted to a float line. It is ideal to be mounted on butt of gun for float line connection. It has an ideal size for buoy connections.

CODE

FA390037

FLOAT ROPE



DESCRIPTION:

Length: 98.5 ft | 30 m. Strength: 330.7 lb | 150 kg.

Thickness (diameter): 0.24 in | 6 mm. Style of braiding: weave Long rope of 100 ft (approx.) made in strong polyethylene for use as an accessory for freediving or spearfishing. The rope is composed by weaving a group of 16 twists each consisting of 6 thin wires of 0.25mm diameter twisted together.

CODE

TA613530

WEIGHT BELT

CODE	PRODUCTS	CASE PACK
UW100000	Metal Buckle - Black	10
UW100001	Metal Buckle - Neon Yellow	10
TA627020	Hard Plastic Buckle - Blue	10



ELASTIC BELT NEW COLOR 2023

CODE	PRODUCT	CASE PACK
TA626000	Premium Marseillaise Rubber Belt - Black	10
TA626020	Premium Marseillaise Rubber Belt - Blue	10
TA626010	Quick-Release Elastic Belt W/ Metal Buckle - Black	10
XTA626011	Quick-Release Elastic Belt W/ Metal Buckle - Yellow	10
XTA626020	Quick-Release Elastic Belt W/ Metal Buckle - Blue	10



WEIGHT BELT KEEPER

CODE	PRODUCT	CASE PACK
TA627100	Hard Plastic (5 Pack) Black	10
TA627101	Stainless Steel (2 Pack) Silver	10
TA627102	D-Ring 26mm Stainless Steel (2 Pack)	10



LIBRA BALLAST WEIGHT BAG

The Libra is the bag for carrying the ballast needed for your scuba diving equipment. It can carry also the weights used by the freedivers. It is made in strong and resistant Denier fabric, for long-lasting use and for a huge weight. Built rugged, the double webbing encircles the entire bag for added strength and joins to form a padded handle.

CODE
UB500550



BAGS & BACKPACKS FREEDIVING



WATERPROOF POLYESTER | EXTERNAL WATERPROOF POCKET

TUNA DRY

NEW COLOR 2023

WHEELED OVERSIZED BAG



120 LITERS

BLACK/RED

BLACK/BLUE

NEW 2023

The Tuna Dry Wheel Bag is an ideal bag for transporting any kind of equipment for water activities keeping protected from water. It has a capacity of 120 liters | 4.23 cu ft that can fit also long freediving fins. Made of highly resistant materials, it allows you to keep your equipment dry and protect electronic devices. Equipped with central handles/shoulder straps and side handles to facilitate transport even with the presence of wheels. The presence of wheels facilitates transport even on long routes. Equipped with practical central handles/shoulder straps and reinforced side handles.

A practical waterproof side pocket keeps small items dry and protects electronic devices. Internal straps with clip closure allow you to secure the sports equipment during transport. Made of very resistant materials, with well-finished stitching. The lower part is reinforced, shockproof and insulating. Waterproof seal. Keep your equipment dry, protect electronic devices and documents from water, dust, and sand.

CODE	COLOR
XUB976200	Black/Red
XUB976220	Black/Blue

TUNA	DIMENSION (LENGTH-WIDTH-HEIGHT)		VOLUME			WEIGHT	
	cm	in	liter	cu ft	kg	lb	
	40 x 41 x 95	37 1/2 x 15 3/4 x 16 1/8	120	4.23	3.5 kg	7 lb 11 oz	



TECHNICAL FEATURES

- Made of polyester
- External pocket
- Side handles and shoulder straps

INSIDE STRAPS



WITH WHEELS



SEMI RIGID CASE



WATER RESISTANT ZIPPER | HIGH FREQUENCY WELDING | FOR GARA FINS | 135 L

GORILLA PRO

HEAVY-DUTY WATERPROOF GEAR BAG



135 LITERS



BLACK

CAMO BLUE

CAMO GREY

One large and roomy bag. The bag is long enough to hold even the long freediving fins. It is made from a strong radio frequency (RF) welded seam PVC and is waterproof. Equipment can be washed with water while still inside the bag. Once you have finished washing your gear, the bag has a special

draining cap situated at one end to let water out easily and conveniently. Comes with handy top grab carry handles and two straps that can also be used as shoulder straps. No water comes out when transported, even by car.

CODE	COLOR	CASE PACK
UA925710	Black	10
XUA925798	Camo Blue	10
XUA925799	Camo Grey	10

GORILLA XL	DIMENSION (LENGTH-WIDTH-HEIGHT)		VOLUME			WEIGHT	
	cm	in	liter	cu ft	kg	lb	
	95 x 34 x 42	37 x 13 x 16	135	4.77	1.5 kg	3.5 lb 5 oz	



TECHNICAL FEATURES

- Made from a strong radio frequency (RF) welded seam PVC
- Waterproof fabric
- Durable straps for carrying any style
- 2 Shoulder straps and handle straps on both ends of the bag
- Draining cap for washing bag and equipment
- Strong YKK zipper
- Front zipped pocket

ELECTRONICALLY WELDED



SPECIAL DRAINING CAP



TOP VIEW



HIGH VOLUME



DRY GARA BACKPACK

HIGH-VOLUME DRY BACKPACK



Comfortable watertight daypack made of black highly resistant PVC. It is the ideal bag for carrying your equipment in any challenging situation, even on a motorcycle.

It has side fasteners for carrying spear guns and a special front pocket for storing long fins.

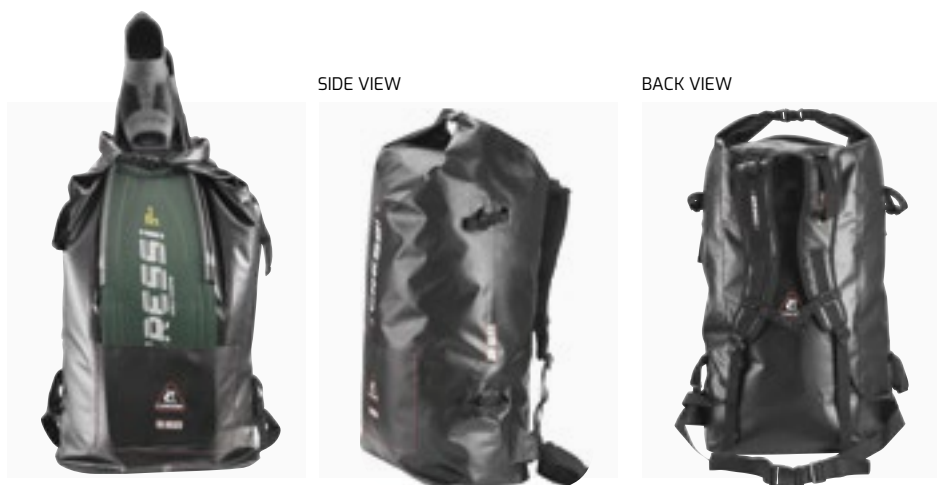

CODE	SIZE	CASE PACK
UA925800	60 liters	10

	DIMENSION (LENGTH-WIDTH-HEIGHT)		VOLUME		WEIGHT	
	CM	IN	LITER	CU FT	KG	LB
DRY GARA	39.5 x 23.5 x 66	15 x 9 x 26	60	2.12	1.12 kg	2 lb 7.5 oz



TECHNICAL FEATURES

- Waterproof polyester
- External waterproof pocket

60
LITERS

2 X GUN-HOLDER



FIN-HOLDER



PIOVRA XL

85
LITERS

TECHNICAL FEATURES

- Made of 900/600 Denier with 6P Free coating
- Backstrap material:** 900 Denier reversed
- SBS 10# zipper
- Bottom:** anti-skid material
- Lining:** 210 Denier

NEW TALLER VERSION TO ACCOMMODATE THE GARA MODULAR IMPULSE



The Piovra XL is a special backpack conceived for transporting spearfishing and freediving gears. It features a main compartment big enough for storing a pair of long fins (up to 39 in / 100 cm) equipped with a netting for ventilation. It is possible to store a wetsuit, mask, snorkels, belt and various spearfishing gear. Zip closing with 2 zippers with eyelet for padlocks.

The Piovra has a secondary cooler-type compartment for storing cold drinks or fishes.

The front has a zigzag elastic cord with an adjustable locker ideal for quick storage.

Both sides have two elastic bands that are ideal for securing two spearguns. When the bag is empty it is possible to reduce the volume thanks to the lateral compression straps.

The shoulder straps have the buckle chest strap height adjustable. Side handle.

Wear-resistant bottom. Top hook for hanging the bag.

CODE	CASE PACK
XVB990101	10

	DIMENSION (LENGTH-WIDTH-HEIGHT)		VOLUME		WEIGHT	
	CM	IN	LITER	CU FT	KG	LB
PIOVRA XL	30 x 30 x 130	11 3/4 x 11 3/4 x 44	85	3.00	1.6 kg	3 lb 8 oz

GARA PREMIUM BAG

A newly renovated version of the Gara Bag. The unique and functional bag with the necessary space to store fins, mask and snorkel. The famous Gara fins, the long freediving fins, can be accommodated easily in this shoulder bag for comfortable and secure transportation.

The bottom part is made with a strong mesh which allows water to drain. Practical front pocket with zip closure for storing personal stuff. It features a padded adjustable shoulder strap.



CODE	CASE PACK
UB931081	5

LONG FIN SET BAG



The Long Fins Set Bag is a functional bag with the necessary space to store fins, mask and snorkel.

Also longer fins such as Gara are

accommodated easily in this shoulder bag for comfortable and secure transportation. Bag is made from durable nylon material.

CODE
US451031

TECHNICAL FEATURES
<ul style="list-style-type: none"> • Nylon 600 denier • Front pocket

TECHNICAL FEATURES
<ul style="list-style-type: none"> • Nylon 600 denier • Front pocket

DIMENSION
HEIGHT: 94 CM, 37.0 IN
WIDTH: 24.5 CM, 9.6 IN
LENGTH: 17.5 CM, 6.9 IN



CRESSI SPEARFISHING
2023 COLLECTION

When it comes to spearing fish, the gear a spearfisherman uses makes all the difference in the world. Cressi makes everything the successful spearfisherman needs, from spearguns to wetsuits, dive knives, masks, fins, and more. The brand personality for the Spearfishing line will be reflected in colors that range from seafoam green to deep green/cyan. The green mimics the color of seaweed and underwater forests, perfect colors for Cressi's spearfishing products that date back to the company's beginnings but are always being updated, refined and improved to meet the needs of today's spearfishermen.

CRESSI

**BORN FROM
THE SEA**

SPEARFISHING





CHEROKEE POWER

UNLIMITED POWER

Anticorrosive black frame with integrated spear guide, grip made of engineering plastic reinforced with glass fibre, high or low soft sternal support. Composite material release mechanism with trigger, release tooth and lateral guide line release obtained from the base. The shock absorber makes silent the release of the shaft. Reversible side safety mechanism. Reinforced reel with steel pin

buckle. Head for double elastic with magnetic spear lock: as soon as the spear is put in place, it is held by two magnets mounted in a watertight chamber. This characteristic guarantees maximum speed of reset without the disadvantages of conventional mechanical restraint systems.



CODE	SIZE	CASE PACK
FE365200	90 cm	6
FE365300	100 cm	6
FE365400	110 cm	6
FE365500	120 cm	6
FE365600	130 cm	6
FE365700	140 cm	6

ACCESSORIES

CODE	PRODUCT
FA359050	REEL R50
FA359030	REEL R30

SPARE PARTS

CODE	PRODUCT	GUN LENGTH
FA406120	INOX FINNED SHAFT Ø 7mm BT. FLOPPER (120 cm)	90 cm
FA406130	INOX FINNED SHAFT Ø 7mm BT. FLOPPER (130 cm)	100 cm
FA406140	INOX FINNED SHAFT Ø 7mm BT. FLOPPER (140 cm)	110 cm
FA406150	INOX FINNED SHAFT Ø 7mm BT. FLOPPER (150 cm)	120 cm
FA406160	INOX FINNED SHAFT Ø 7mm BT. FLOPPER (160 cm)	130 cm
FA400525	CIRCULAR BAND w/LW Ø 16mm ID3.2mm - BLUE (63cm) (GUN 100)	100 cm
FA400526	CIRCULAR BAND w/LW Ø 16mm ID3.2mm - BLUE (69cm) (GUN 110)	110 cm
FA400527	CIRCULAR BAND w/LW Ø 16mm ID3.2mm - BLUE (77cm) (GUN 120)	120 cm
FA400528	CIRCULAR BAND w/LW Ø 16mm ID3.2mm - BLUE (81cm) (GUN 130)	130 cm
FB1532162	BAND RUBBER TUBING 50FT - BLUE - Ø 16mm - ØID 3.2	

TECHNICAL FEATURES

- Ultra light release box and trigger
- Lateral guide line release with automatic return
- Interchangeable high-low sternal support
- Shaft ø 7 mm with tig welded and drilled fins and reversed flopper
- Quick loading magnetic open muzzle
- Double circular band ø 16 mm with a 2 mm lined wishbone
- Rigged barrel ø 28 mm with shaft guide

FINNED SHAFT Ø 7 mm WITH BOTTOM FLOPPER



QUICK LOADING MAGNETIC OPEN MUZZLE



DOUBLE CIRCULAR BAND Ø 16 mm



SHOCK ABSORBER



RIGGED AND REINFORCED BARREL WITH SHAFT GUIDE



INTERCHANGEABLE HIGH-LOW SUPPORT



ULTRA LIGHT HANDLE



CHEROKEE FAST

POWERFUL WITH EASY LOADING

Anticorrosive black frame with integrated spear guide. Grip made of engineering plastic reinforced with glass fibre. High or low soft sternal support. Composite material release mechanism with a trigger, release tooth and lateral guide line release obtained from the base. The shock absorber makes silent the release of the shaft. Reversible side-safety mechanism. Reinforced reel with steel pin

buckle. Head for double elastic with magnetic spear lock: as soon as the spear is put in place. It is held by two magnets mounted in a watertight chamber. This characteristic guarantees maximum speed of reset without the disadvantages of conventional mechanical restraint systems.



ULTRA LIGHT HANDLE

REEL INCLUDED

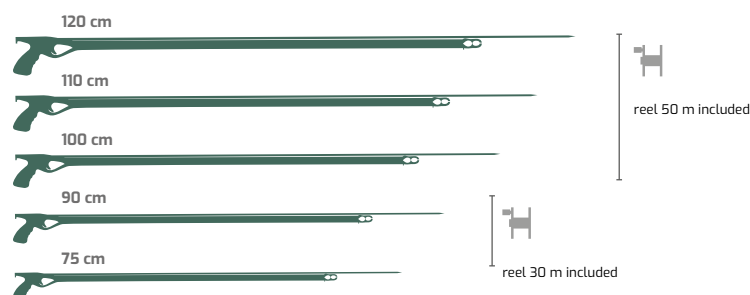

CODE	SIZE	CASE PACK
FE363100	75 cm	6
FE363200	90 cm	6
FE363300	100 cm	6
FE363400	110 cm	6
FE363500	120 cm	6

✓ READY FOR USE MADE IN ITALY

TECHNICAL FEATURES

- Anticorrosive black barrel with integrated spear guide
- Handle made of engineering plastic reinforced with fiberglass
- Adjustable ergonomic handle, two screws allow you to set a larger or smaller handle
- Sideline release integrated into the body of the gun
- Cobra design open-muzzle featuring softer angles for reducing friction with the bands
- Muzzle with the spear-lock system: two magnets keep the shaft in position
- Shock absorber for silencing the release of the shaft
- Reel included featuring a quick-release mounting bracket
- Choice between two sternal supports, one long and one short
- Supplied with two elastic bands with nylon cord (Ø 14mm) and a stainless steel shaft (Ø 6 mm)

FINNED SHAFT Ø 6.5 MM WITH BOTTOM FLOPPER



QUICK LOADING MAGNETIC OPEN MUZZLE



DOUBLE CIRCULAR BAND Ø 14 MM



INTERCHANGEABLE HIGH-LOW SUPPORT



SPARE PARTS

CODE	PRODUCT	GUN LENGTH
FA404903	INOX FINNED SHAFT Ø 6.5mm BT. FLOPPER (105 cm)	75 cm
FA404904	INOX FINNED SHAFT Ø 6.5mm BT. FLOPPER (120 cm)	90 cm
FA404905	INOX FINNED SHAFT Ø 6.5mm BT. FLOPPER (130 cm)	100 cm
FA404906	INOX FINNED SHAFT Ø 6.5mm BT. FLOPPER (140 cm)	110 cm
FA404907	INOX FINNED SHAFT Ø 6.5mm BT. FLOPPER (150 cm)	120 cm
FA400483	CIRCULAR BAND w/LW Ø 14mm ID3.2mm - RED (48cm) (GUN 75)	120 cm
FA400484	CIRCULAR BAND w/LW Ø 14mm ID3.2mm - RED (57cm) (GUN 90)	120 cm
FA400485	CIRCULAR BAND w/LW Ø 14mm ID3.2mm - RED (63cm) (GUN 100)	120 cm
FA400486	CIRCULAR BAND w/LW Ø 14mm ID3.2mm - RED (69cm) (GUN 110)	120 cm
FA400487	CIRCULAR BAND w/LW Ø 14mm ID3.2mm - RED (77cm) (GUN 120)	120 cm
FB1516168	BAND RUBBER TUBING 50FT - RED - Ø 16mm - ØID 1.6	



CHEROKEE EXO

MODULAR POWER

Anticorodal black frame with integrated spear guide, grip made of engineering plastic reinforced with glass fibre, high or low soft sternal support. Ultra-light triggering case with trigger, release mechanism and line ring on the side in AISI 316, machined from solid with a CNC process. The shock absorber makes silent the release of the shaft. Reversible side-safety mechanism. Reinforced reel with steel pin buckle. Head for double

elastic with magnetic spear lock: as soon as the spear is put in place, it is held by two magnets mounted in a watertight chamber. This characteristic guarantees maximum speed of reset without the disadvantages of conventional mechanical restraint systems. The speargun is supplied with a 16 mm natural latex elastic, with Dyneema wishbone.

✓ **READY FOR USE** **MADE IN ITALY**

TECHNICAL FEATURES

- Ultra light release box and trigger
- Lateral guide line release with automatic return
- Interchangeable high-low sternal support
- Shaft Ø 6.5 mm
- Quick loading magnetic open muzzle
- Circular band Ø 16 mm with lined wishbone 2 mm
- Rigged barrel Ø 28 mm with shaft guide
- Measurements: 110, 100, 90, 75 & 60 cm

QUICK LOADING MAGNETIC OPEN MUZZLE



SHOCK ABSORBER



RIGGED AND REINFORCED BARREL WITH SHAFT GUIDE



INTERCHANGEABLE HIGH / LOW SUPPORT



ULTRA LIGHT HANDLE



Ultra light release box and trigger

Lateral guide line release with automatic return



CODE	SIZE	CASE PACK
FE364000	60 cm	6
FE364100	75 cm	6
FE364200	90 cm	6
FE364300	100 cm	6
FE364400	110 cm	6

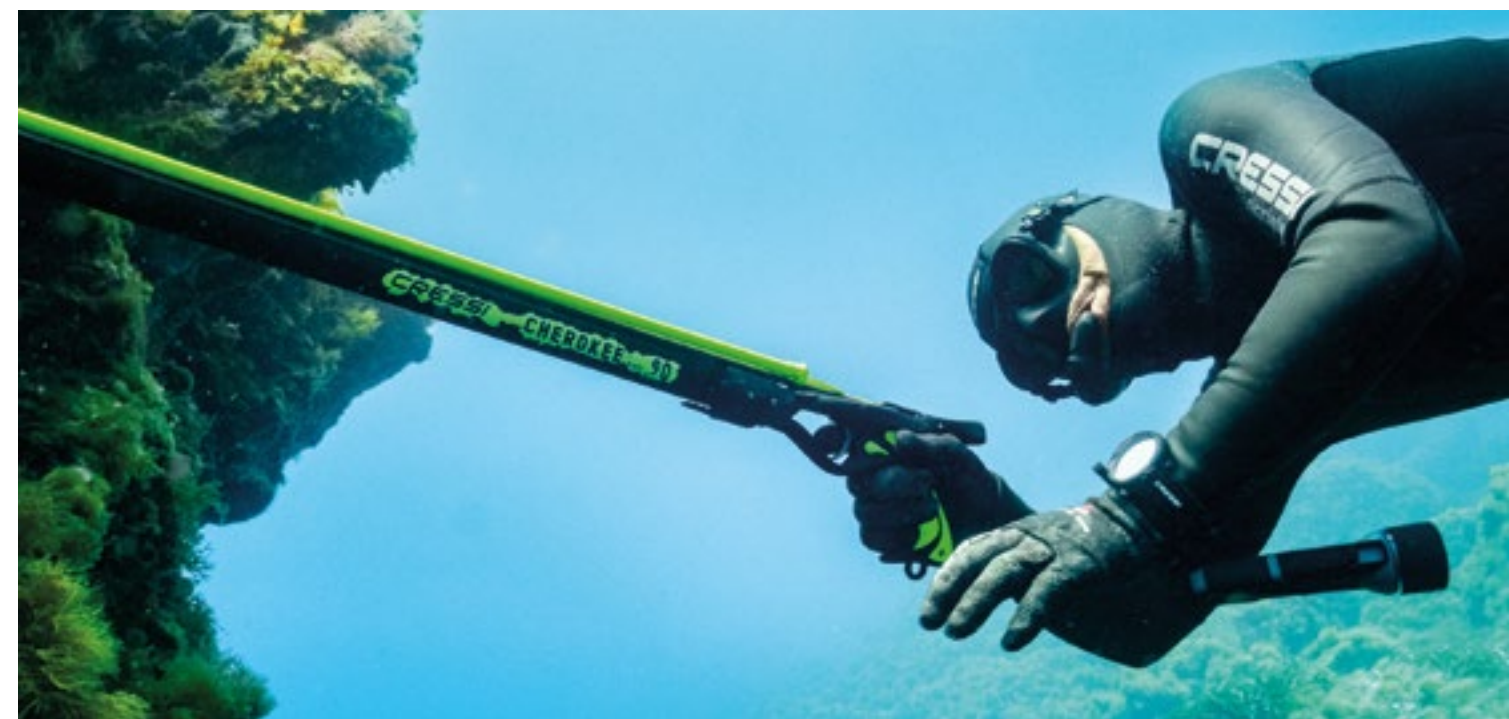

ACCESSORIES

CODE	PRODUCT
FA359050	REEL R50
FA359030	REEL R30

SPARE PARTS

CODE	PRODUCT	GUN LENGTH
FA404902	INOX FINNED SHAFT Ø 6.5mm BT. FLOPPER [90 cm]	60 cm
FA404903	INOX FINNED SHAFT Ø 6.5mm BT. FLOPPER [105 cm]	75 cm
FA404904	INOX FINNED SHAFT Ø 6.5mm BT. FLOPPER [120 cm]	90 cm
FA404905	INOX FINNED SHAFT Ø 6.5mm BT. FLOPPER [130 cm]	100 cm
FA404906	INOX FINNED SHAFT Ø 6.5mm BT. FLOPPER [140 cm]	110 cm
FA400562	CIRCULAR BAND w/LW Ø 16mm ID3.2mm - LIME [39cm] (GUN 60)	60 cm
FA400563	CIRCULAR BAND w/LW Ø 16mm ID3.2mm - LIME [48cm] (GUN 75)	75 cm
FA400564	CIRCULAR BAND w/LW Ø 16mm ID3.2mm - LIME [57cm] (GUN 90)	90 cm
FA400565	CIRCULAR BAND w/LW Ø 16mm ID3.2mm - LIME [63cm] (GUN 100)	100 cm
FA400566	CIRCULAR BAND w/LW Ø 16mm ID3.2mm - LIME [69cm] (GUN 110)	110 cm



YUMA FAST

THE GUN FOR AMBUSH AND DEN

Anticorrosive black frame with integrated spear guide, grip made of engineering plastic reinforced with glass fiber, integrated soft sternal support. Ultra-light triggering case with a release mechanism in AISI 316. Dovetail reel coupling. Head for double elastic with magnetic spear lock: as soon as the spear is put in place, it is held by two

magnets mounted in a watertight chamber. This characteristic guarantees maximum speed of reset without the disadvantages of conventional mechanical restraint systems. The speargun is supplied with a double 14 mm natural latex band, with a Dyneema wishbone.



CODE	SIZE	CASE PACK
FE349000	60 cm	6
FE349100	75 cm	6
FE349200	90 cm	6
FE349300	100 cm	6

✓ READY FOR USE MADE IN ITALY

TECHNICAL FEATURES

- Guide line release with automatic return
- Integrated sternal support
- Shaft \varnothing 6 mm with tig welded fins and reversed flopper
- Quick loading magnetic open muzzle
- Circular band \varnothing 14 mm with a 2 mm lined wishbone
- Rugged barrel \varnothing 26 mm with shaft guide

FINNED SHAFT \varnothing 6.5 MM WITH BOTTOM FLOPPER



14 MM CIRCULAR BAND WITH A 2 MM LINED WISHBONE



SHOCK ABSORBER



RUGGED BARREL WITH SHAFT GUIDE



ULTRALIGHT ERGONOMIC HANDLE, ANGLED FOR INCREASING PRECISION



SPARE PARTS

CODE	PRODUCT	GUN LENGTH
FA407090	INOX FINNED SHAFT \varnothing 6mm BT. FLOPPER (90 cm)	60 cm
FA407105	INOX FINNED SHAFT \varnothing 6mm BT. FLOPPER (105 cm)	75 cm
FA407120	INOX FINNED SHAFT \varnothing 6mm BT. FLOPPER (120 cm)	90 cm
FA407130	INOX FINNED SHAFT \varnothing 6mm BT. FLOPPER (130 cm)	100 cm
FA400483	CIRCULAR BAND w/LW \varnothing 14mm ID3.2mm - RED (48cm) (GUN 75)	120 cm
FA400484	CIRCULAR BAND w/LW \varnothing 14mm ID3.2mm - RED (57cm) (GUN 90)	120 cm
FA400485	CIRCULAR BAND w/LW \varnothing 14mm ID3.2mm - RED (63cm) (GUN 100)	120 cm
FA400486	CIRCULAR BAND w/LW \varnothing 14mm ID3.2mm - RED (69cm) (GUN 110)	120 cm
FA400487	CIRCULAR BAND w/LW \varnothing 14mm ID3.2mm - RED (77cm) (GUN 120)	120 cm
FB1532148	BAND RUBBER TUBING 50FT - RED - \varnothing 14mm - \varnothing ID 3.2	



COMANCHE RAIL

THE HISTORY OF OUR SPEARGUNS

The Comanche Rail is the latest version of Cressi's world champion spear gun. The high-strength, anti-corrosion aluminum barrel now features an integrated guide rail for increased accuracy. The high-tech and lightweight modern thermoplastic hand grip and muzzle guarantee the utmost maneuverability in the water, adding to the Comanche Rail's accuracy. The compact and hydrodynamic muzzle makes it possible to add a second lower band to increase power for larger prey. The muzzle and handgrip are configured so

the shooter can easily acquire a sight picture of the gun while simultaneously tracking their target. The Comanche Rail comes with a heat-treated 6.0 mm spring stainless steel 17-4 PH notched shaft, 16 mm parallel power bands, metal articulated wishbone, and a shaft rigged to the gun with a 1.4 mm braided multifilament line rated to 80 kg | 176 lb. The Comanche Rail also features a dovetail notch in front of the trigger guard, allowing a reel to be mounted.

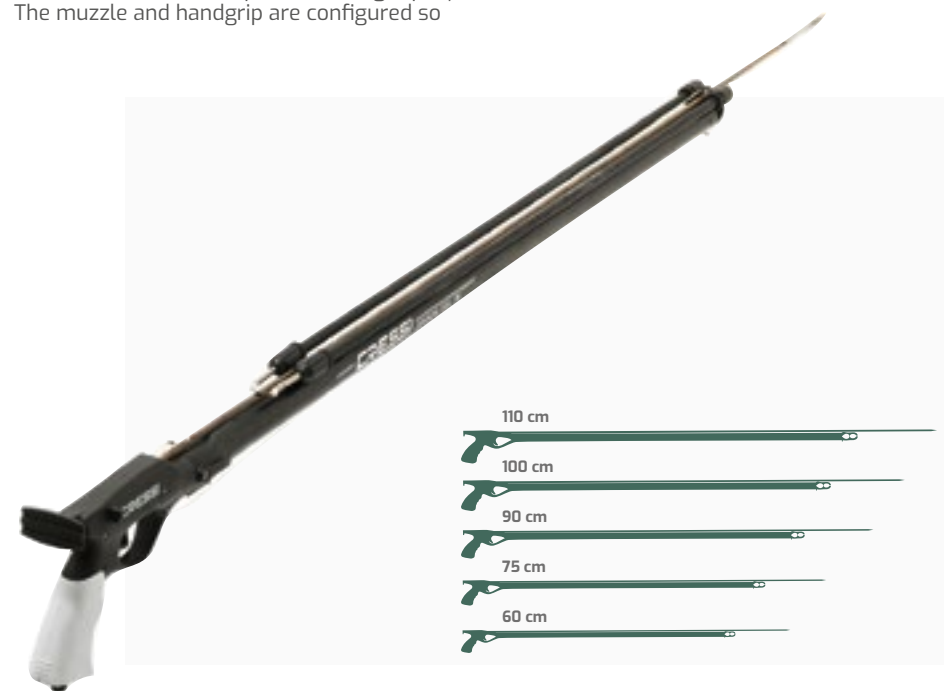

CODE	SIZE	CASE PACK
FE359000	60 cm	6
FE359100	75 cm	6
FE359200	90 cm	6
FE359300	100 cm	6
FE359400	110 cm	6

ACCESSORIES

CODE	PRODUCT
FA359050	REEL R50
FA359030	REEL R30

SPARE PARTS

CODE	PRODUCT	GUN LENGTH
FA410002	INOX NOTCHED SHAFT Ø 6mm [90cm]	60 cm
FA410003	INOX NOTCHED SHAFT Ø 6mm [105cm]	75 cm
FA410004	INOX NOTCHED SHAFT Ø 6mm [115cm]	90 cm
FA410005	INOX NOTCHED SHAFT Ø 6mm [125cm]	100 cm
FA410006	INOX NOTCHED SHAFT Ø 6mm [130cm]	110 cm
FA400002	PARALLEL BAND Ø 16mm [16cm]	60 cm
FA400003	PARALLEL BAND Ø 16mm [18.5cm]	75 cm
FA400004	PARALLEL BAND Ø 16mm [20cm]	85 cm
FA400005	PARALLEL BAND Ø 16mm [22cm]	90 cm
FA400006	PARALLEL BAND Ø 16mm [25.5cm]	100 cm
FA400007	PARALLEL BAND Ø 16mm [27.5cm]	110 cm



✓ READY FOR USE MADE IN ITALY

TECHNICAL FEATURES

- Anti-corrosion aluminum barrel with a shaft guide
- Lightweight angled handle to increase shot's precision
- Hydrodynamic closed muzzle
- Dovetail notch for reel assembling

NOTCHED SHAFT Ø 6.0 MM



ULTRA COMPACT CLOSED MUZZLE QUICKLOAD MINI SPEARHEAD



Ø 16 MM PARALLEL BANDS WITH METAL WISHBONE



RUGGED AND REINFORCED BARREL WITH SHAFT GUIDE



SPECIAL HANDLE ANGLE TO INCREASE THE SHOT'S PRECISION



APACHE

ROBUST AND MINIMALIST

Apache is Cressi's entry level speargun and can also be handily used as a second gun. This gun is an excellent choice when fishing in holes, around rocks, shallows and where the target is in close proximity. The Apache incorporates a closed muzzle, which helps with ease of loading and improved accuracy. The sealed barrel is anodized for

enhanced corrosion resistance, while the ergonomic molded handle permits easier maneuverability and quick muzzle pointing. The power band is fitted with a standard stainless wishbone and the gun includes the widely preferred Tahitian style flopper shaft.



CODE	SIZE	CASE PACK
FE341035	35 cm	6
FE341045	45 cm	6
FE341060	60 cm	6
FE341075	75 cm	6
FE341090	90 cm	6

SPARE PARTS

CODE	PRODUCT	GUN LENGTH
FA350535	STEEL NOTCHED THREADED SHAFT Ø 7.0 mm [65 cm]	35 cm
FA350545	STEEL NOTCHED THREADED SHAFT Ø 7.0 mm [75 cm]	45 cm
FA350560	STEEL NOTCHED THREADED SHAFT Ø 7.0 mm [90cm]	60 cm
FA350575	STEEL NOTCHED THREADED SHAFT Ø 7.0 mm [105 cm]	75 cm
FA350590	STEEL NOTCHED THREADED SHAFT Ø 7.0 mm [115 cm]	90 cm
FA340019	CIRCULAR BAND Ø 13 mm [24 cm] GUN 35	35 cm
FA340020	CIRCULAR BAND Ø 13 mm [31 cm] GUN 45	45 cm
FA340021	CIRCULAR BAND Ø 13 mm [34 cm] GUN 60	60 cm
FA340022	CIRCULAR BAND Ø 13 mm [39 cm] GUN 75	75 cm
FA340023	CIRCULAR BAND Ø 13 mm [44 cm] GUN 90	90 cm
FA390002	INOX SPEAR HEAD MONO-FLOPPER Ø 6.5mm THREAD	
FA350020	JOINTED WISHBONE TYPE A	



✓ READY FOR USE MADE IN ITALY

TECHNICAL FEATURES

- Ergonomic molded handle for easier maneuverability
- Durable anodized heavy duty sealed aluminum barrel
- Closed muzzle for improved accuracy and ease of loading
- Advanced Tahitian-style flopper shaft for superior penetration
- Replaceable band and wishbone assembly is user friendly

SPECIAL HANDLE ANGLE TO INCREASE THE SHOT'S PRECISION



Ø 6.5 MM NOTCHED THREADED SHAFT



CLOSED MUZZLE



BARREL Ø 26 MM



Ø 13 MM CIRCULAR BAND WITH METAL WISHBONE



KRAKEN

17-4 PH FINNED SHAFT Ø 7 MM

BOTTOM FLOPPER



CODE	SIZE	CASE PACK
FA406120	120 cm	6
FA406130	130 cm	6
FA406140	140 cm	6
FA406150	150 cm	6
FA406160	160 cm	6

17-4 PH FINNED SHAFT Ø 6.5 MM

BOTTOM FLOPPER



CODE	SIZE	CASE PACK
FA404902	90 cm	6
FA404903	105 cm	6
FA404904	120 cm	6
FA404905	130 cm	6
FA404906	140 cm	6
FA404907	150 cm	6

17-4 PH FINNED SHAFT Ø 6 MM

BOTTOM FLOPPER



CODE	SIZE	CASE PACK
FA407090	90 cm	6
FA407105	105 cm	6
FA407120	120 cm	6
FA407130	130 cm	6

INOX FINNED SHAFT Ø 7 MM

TOP FLOPPER

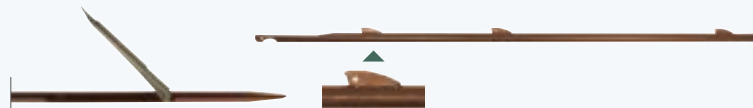

CODE	SIZE	CASE PACK
FA405103	115 cm	6
FA405104	130 cm	6
FA405105	140 cm	6
FA405106	150 cm	6
FA405107	160 cm	6

STAINLESS STEEL NOTCHED SHAFT Ø 6.5 MM

TOP FLOPPER

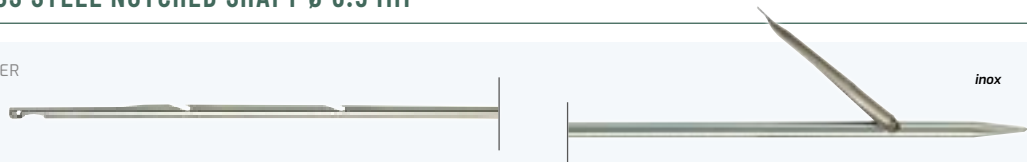

CODE	SIZE	CASE PACK
FA410501	75 cm	6
FA410502	90 cm	6
FA410503	105 cm	6
FA410504	115 cm	6
FA410505	125 cm	6
FA410506	130 cm	6
FA410507	140 cm	6
FA410508	150 cm	6

SLING GUN SHAFTS

17-4 PH NOTCHED SHAFT Ø 6.5 MM

TOP FLOPPER



CODE	SIZE	CASE PACK
FA410002	90 cm	6
FA410003	105 cm	6
FA410004	115 cm	6
FA410005	125 cm	6
FA410006	130 cm	6
FA410007	140 cm	6
FA410008	150 cm	6

INOX FINNED THREADED SHAFT Ø 7 MM

Ø 6 MM THREAD

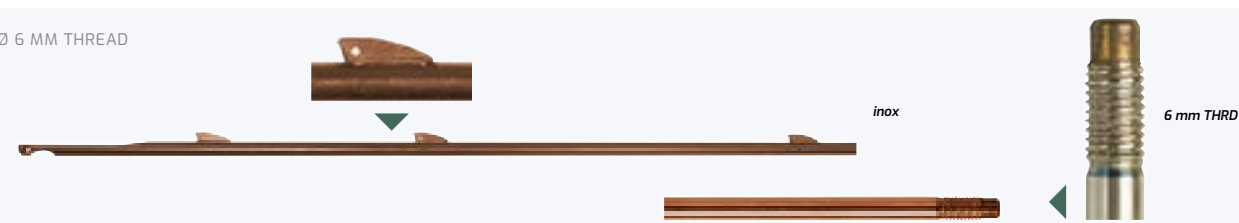

CODE	SIZE	CASE PACK
FA405203	115 cm	6
FA405204	130 cm	6
FA405205	140 cm	6
FA405206	150 cm	6
FA405207	160 cm	6

STEEL NOTCHED THREADED SHAFT Ø 7 MM

Ø 6 MM THREAD



CODE	SIZE	CASE PACK
FA350535	65 cm	6
FA350545	75 cm	6
FA350560	90 cm	6
FA350575	105 cm	6
FA350590	115 cm	6

CONVERSION chart

Inches	>	Millimeters	:	Multiply By 25.4
Inches	>	Centimeters	:	Multiply By 2.54
Feet	>	Meters	:	Multiply By 0.3048
Pounds	>	Grams	:	Multiply By 454

in	15/64"	9/32"	5/16"	15/32"	1/2"	9/16"	5/8"	3/4"
mm	6	7	8	12	13	14	16	19

in	13.77	15.74	17.71	21.65	23.62	27.55	29.52	33.46	35.43	37.40	39.37	41.33	43.30	45.27	47.24
cm	35	40	45	55	60	70	75	85	90	95	100	105	110	115	120

SLIP TIP + FLOPPER + RETAINER

The Slip Tip has a Flopper and a Retainer. Designed with a Tahitian Style Point. It is made of stainless steel 17-4 PH H900 heat treatment.

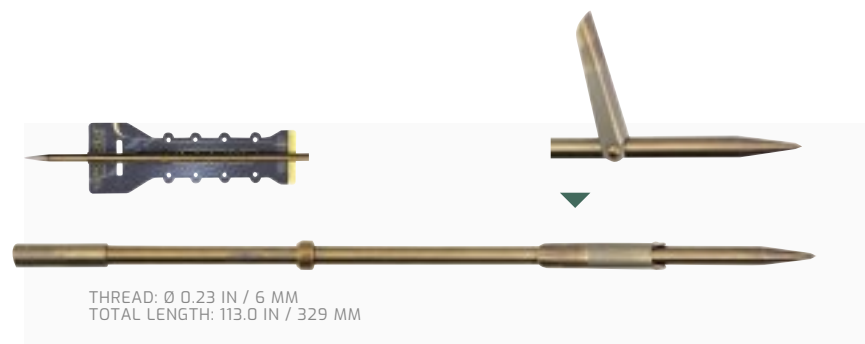

THREAD: Ø 0.23 IN / 6 MM
TOTAL LENGTH: 113.0 IN / 329 MM

CODE	PRODUCT	CASE PACK
USX021100	SLIP TIP 6 mm + FLOPPER - THREAD - 17-4 PH + CABLE 2 mm	10

INOX SPEAR HEAD MONO-FLOPPER

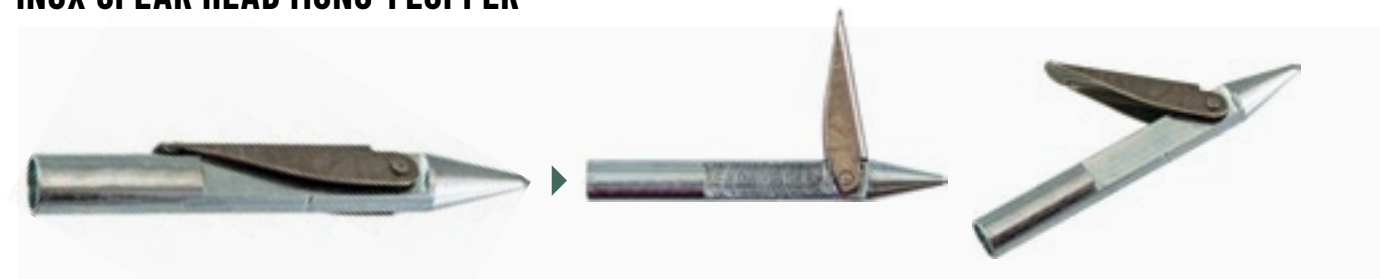

CODE	PRODUCT
FA390002	INOX SPEAR HEAD MONO-FLOPPER ø 6.5mm THREAD



RUBBER BAND TUBING 50 FT



DESCRIPTION:
Reinforced internal tube, bigger density (shore 45°) to maximize the resistance to pressure of the ball over the internal walls of the rubber.

DESCRIPTION:
Reinforced internal tube, bigger density (shore 45°) to maximize the resistance to pressure of the ball over the internal walls of the rubber.

DESCRIPTION:
Reinforced internal tube, bigger density (shore 45°) to maximize the resistance to pressure of the ball over the internal walls of the rubber.

CODE	COLOR	SIZE	STYLE	CASE PACK
FB1516142	Blue	50 ft 15 m	Ø 14mm - ØID 1.6	1
FB1516145	Black	50 ft 15 m	Ø 14mm - ØID 1.6	1
FB1516148	Red	50 ft 15 m	Ø 14mm - ØID 1.6	1
FB1516162	Blue	50 ft 15 m	Ø 16mm - ØID 1.6	1
FB1516165	Black	50 ft 15 m	Ø 16mm - ØID 1.6	1
FB1516168	Red	50 ft 15 m	Ø 16mm - ØID 1.6	1
FB1532142	Blue	50 ft 15 m	Ø 14mm - ØID 3.2	1
FB1532145	Black	50 ft 15 m	Ø 14mm - ØID 3.2	1
FB1532148	Red	50 ft 15 m	Ø 14mm - ØID 3.2	1
FB1532162	Blue	50 ft 15 m	Ø 16mm - ØID 3.2	1
FB1532165	Black	50 ft 15 m	Ø 16mm - ØID 3.2	1
FB1532168	Red	50 ft 15 m	Ø 16mm - ØID 3.2	1
FB1532182	Blue	50 ft 15 m	Ø 18mm - ØID 3.2	1
FB1532185	Black	50 ft 15 m	Ø 18mm - ØID 3.2	1
FB1532188	Red	50 ft 15 m	Ø 18mm - ØID 3.2	1

CIRCULAR BAND

W / LW Ø 16 mm | Ø 14 mm



CODE	COLOR	SIZE	STYLE
FA400524	Blue	57 cm	Ø 16 mm - ØID 3.2
FA400525	Blue	63 cm	Ø 16 mm - ØID 3.2
FA400526	Blue	69.5 cm	Ø 16 mm - ØID 3.2
FA400527	Blue	77 cm	Ø 16 mm - ØID 3.2
FA400528	Blue	81 cm	Ø 16 mm - ØID 3.2
FA400562	Lime	39 cm	Ø 16 mm - ØID 3.2
FA400563	Lime	48 cm	Ø 16 mm - ØID 3.2
FA400564	Lime	57 cm	Ø 16 mm - ØID 3.2
FA400565	Lime	63 cm	Ø 16 mm - ØID 3.2
FA400566	Lime	69 cm	Ø 16 mm - ØID 3.2
FA400482	Red	39 cm	Ø 14 mm - ØID 3.2
FA400483	Red	48 cm	Ø 14 mm - ØID 3.2
FA400484	Red	57 cm	Ø 14 mm - ØID 3.2
FA400485	Red	63 cm	Ø 14 mm - ØID 3.2
FA400486	Red	69 cm	Ø 14 mm - ØID 3.2
FA400487	Red	77 cm	Ø 14 mm - ØID 3.2

CIRCULAR RUBBER BAND

Ø 18 mm | Ø 16 mm

PURE DYNEEMA
HIGH STRENGTH.
200KG (TENSILE STRENGTH)



CODE	SIZE	STYLE	CASE PACK
FA400153	47 cm	Ø 16 mm	1
FA400154	58 cm	Ø 16 mm	1
FA400155	63 cm	Ø 16 mm	1
FA400156	69 cm	Ø 16 mm	1
FA400157	75 cm	Ø 16 mm	1

DESCRIPTION:
Designed to use with Finned Shaft. Stainless steel spheres 7 mm maximum diameter; (bottleneck with lock out 2mm in diameter). This design ensures the lock without forcing the knot too much and limiting the internal pressure on the rubber.



CIRCULAR BAND

Ø 16 MM | Ø 13 MM

Band: Ø 5/8 in / 16 mm
Thread: Ø 15/32 in / 12 mm
Band: Ø 1/2 in / 13 mm
Thread: Ø 15/32 in / 12 mm



CODE	SIZE	STYLE	CASE PACK
FA340019	26 cm	Ø 13 mm	6
FA340020	31 cm	Ø 13 mm	6
FA340021	34 cm	Ø 13 mm	6
FA340022	39 cm	Ø 13 mm	6
FA340023	44 cm	Ø 13 mm	6

DESCRIPTION:
The rubber, in black color, is made from 100% natural latex by gravity extrusion, to maintain constant the diameter and so the mechanical properties of the band. The diameter of the band is 13mm. The diameter of the thread is 12mm.

PARALLEL ELASTIC

Ø 16 MM



Band: Ø 5/8 in / 16 mm
Thread: Ø 15/32 in / 12 mm

CODE	SIZE	STYLE	CASE PACK
FA400002	16 cm	Ø 16 mm	6
FA400003	18.5 cm	Ø 16 mm	6
FA400004	20 cm	Ø 16 mm	6
FA400005	22 cm	Ø 16 mm	6
FA400006	22.5 cm	Ø 16 mm	6
FA400007	27.5 cm	Ø 16 mm	6

DESCRIPTION:
The rubber, in black color, is made from 100% natural latex by gravity extrusion, to maintain constant the diameter and so the mechanical properties of the band.



REELS

DOVETAIL MOUNTING SYSTEM

These reel models are constructed from a single piece of metal which is worked by a high precision lathe. There are no welds to ensure excellent performance and long life. The frame and the central pin are in AISI 316 steel. The drilling on the frame itself allows it to be used also on arbalete spearguns of different brands. The special clutch

provides an excellent closing torque. The assembly system allows easy maintenance and cleaning. All sizes are equipped with a rewinder ring and size R50 is also equipped with an anti-blocking roller. The models R30 and R50 are equipped with a lightened drum in order to weigh as little as possible on the balance of the speargun.



R20

DESCRIPTION: 65 ft - 20 m with line Ø 1.5 mm
CHEROKEE (ANY MODEL) · MOICANO · COMANCHE RAIL · YUMA FAST · KIOWA · SIOUX · PACIFICO

CODE
FA359020



R30

DESCRIPTION: 100 ft - 30 m with line Ø 1.5 mm

CODE
FA359030



R50

DESCRIPTION: 160 ft - 50 m with line Ø 1.5 mm

CODE
FA359050

REEL

FISHING REEL



TECHNICAL FEATURES

- Durable and effective
- Smooth Multi-Adjustable Clutch Style Drag System
- Clutch Style Drag System, Adjustable when Paying Out Line
- Ergonomic Easily Accessible Star Adjusting Knob
- Vertical Mount Design for Minimal Drag
- Material: Non-Corrosive, Durable and Impact
- Resistant Plastic
- Dimension: 10.9 x 15 x 9.4 centimeters

Reels are an essential accessories for spearfishing big fish. Prevents fish and gun loss. It's constructed from non-corrosive, durable and impact resistant plastic. The dovetail sleigh hook system to the gun

is placed so that the use of the different line-releasing devices is guaranteed, including the mechanical one activated by the trigger.

DESCRIPTION: 130 ft - 40 m with line Ø 1.5 mm
Dovetail Mounting System Cherokee Ocean - Comanche 2.0 - Yuma - Mohicano

CODE
FA359001

HIGH TENACITY LINE

MADE IN ITALY



DESCRIPTION: Diameter: 2.5 mm
Length: 200 mt

CODE
FA390030

WISHBONE STANDARD



CODE
FA350022

JOINTED WISHBONE TYPE -A 3 PRONGS SPEAR HEAD



CODE
FA350020



CODE
FA390008

COMPETITION NYLON THREAD 180



DESCRIPTION: Diameter: 1.80 mm
Length: 5 m | 16.4 ft
2 sleeves included

CODE
FA354524

COMPETITION NYLON THREAD 160



DESCRIPTION: Diameter: 1.60 mm
Length: 5 m | 16.4 ft
2 sleeves included

CODE
FA354522

COMPETITION NYLON THREAD 140



DESCRIPTION: Diameter: 1.40 mm
Length: 5 m | 16.4 ft
2 sleeves included

CODE
FA354525

SHOCK CORD W/ DYNEEMA



CODE
FA354603

SHOCK CORD W/ SNAP



CODE
FA354604

SHOCK CORD W/ PIGTAIL SWIVEL



CODE
FA354605

CRIMPING TOOL

NEW 2023

HAND CRIMPER TOOL

Ideal for crimping mono and stainless steel with the perfectly sized compression jaws to properly crimp. Hardened for durability, these crimpers are ideal for rigging your speargun.



CODE
FA354001

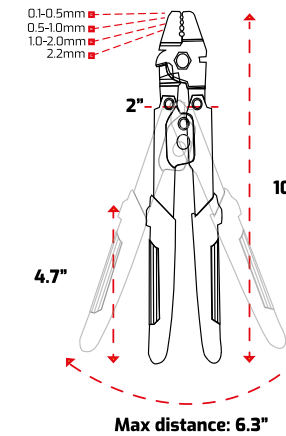

TECHNICAL FEATURES

- High-Carbon Steel Material
- 4 Crimping Positions
- 2 Precision side Cutters



CRIMPING TOOL SET

NEW 2023

DOVETAIL MOUNTING SYSTEM

Ideal for crimping mono and stainless steel with the perfectly sized compression jaws to properly crimp. Hardened for durability, these crimpers are ideal for rigging your speargun.



CODE
FA354002

TECHNICAL FEATURES

- High-Carbon Steel Material
- 4 Crimping Positions
- 2 Precision side Cutters



COPPER DOUBLE BARREL CRIMP SLEEVES Ø1.6MM

NEW 2023



CODE STYLE

FA354530 10 pcs
FA354531 50 pcs

COPPER DOUBLE BARREL CRIMP SLEEVES Ø1.8MM

NEW 2023



CODE STYLE

FA354540 10 pcs
FA354541 50 pcs

COPPER DOUBLE BARREL CRIMP SLEEVES Ø2.0MM

NEW 2023



CODE STYLE

FA354550 10 pcs
FA354551 50 pcs

MULTIFILAMENT Ø1.6mm 200lb

NEW 2023

CODE	COLOR	SIZE	DIAMETER
FM162025	Dark Blue	25 ft	Ø 1.6 mm
FM162050	Dark Blue	50 ft	Ø 1.6 mm
FM165025	Black	25 ft	Ø 1.6 mm
FM165050	Black	50 ft	Ø 1.6 mm
FM168025	Red	25 ft	Ø 1.6 mm
FM168050	Red	50 ft	Ø 1.6 mm
FM169025	Green	25 ft	Ø 1.6 mm
FM169050	Green	50 ft	Ø 1.6 mm

MULTIFILAMENT Ø1.8mm 300lb

NEW 2023

CODE	COLOR	SIZE	DIAMETER
FM182025	Dark Blue	25 ft	Ø 1.8 mm
FM182050	Dark Blue	50 ft	Ø 1.8 mm
FM185025	Black	25 ft	Ø 1.8 mm
FM185050	Black	50 ft	Ø 1.8 mm
FM188025	Red	25 ft	Ø 1.8 mm
FM188050	Red	50 ft	Ø 1.8 mm
FM189025	Green	25 ft	Ø 1.8 mm
FM189050	Green	50 ft	Ø 1.8 mm

MULTIFILAMENT Ø1.8mm 300lb

NEW 2023

CODE	COLOR	SIZE	DIAMETER
FM202025	Dark Blue	25 ft	Ø 2.0 mm
FM202050	Dark Blue	50 ft	Ø 2.0 mm
FM205025	Black	25 ft	Ø 2.0 mm
FM205050	Black	50 ft	Ø 2.0 mm
FM208025	Red	25 ft	Ø 2.0 mm
FM208050	Red	50 ft	Ø 2.0 mm
FM209025	Green	25 ft	Ø 2.0 mm
FM209050	Green	50 ft	Ø 2.0 mm



DRY GUN BAG



A beautiful bag for carrying the spearguns. It features an adjustable shoulder strap and a reinforced handle. It has YKK zip closing long 52.5 in | 133 cm. Inside there is a small pocket with velcro closure. On the top, you can roll and close firmly thanks to the adjustable buckles. Thanks to the special coating the bag is waterproof and will protect the equipment

inside. It is long approximately 70 in (179 cm), enough for carrying long spearguns or other equipment. It is an ideal bag for the spearfishing man that want to protect and easily transport his gear.

CODE	CASE PACK
UA926200	4

NIKITA



Your speargun is a tool you use to bring home food. Like any tool, it needs to be cared for so it will perform to its best ability when needed. The Nikita Gun Bag for Pneumatic Spear Guns will give your speargun the protection it needs when in storage, being transported, and keeps it out of the elements

until needed to and from the dive site. Made from durable sewn fabric, drawstring closure equipped with barrel lock secures the gun in the bag when traveling or in storage.

CODE	SIZE	CASE PACK
UA926500	75 cm 29.5 in	5
UA926600	120 cm 47.2 in	5

TECHNICAL FEATURES

- 840 Denier Nylon with waterproof coating
- YKK zip closing long 133 cm | 52.5 in
- Dimensions: 179 x 30.5 x 20 cm | 70 x 12 x 7.9 in
- Reinforced side handle and shoulder strap



TECHNICAL FEATURES

- Bag for carrying and protecting the Pneumatic guns
- Allows easy and safe transportation of gear
- Drawstring closure equipped with barrel lock
- Durable sewn fabric construction
- Two sizes available: 75 cm | 29.5 in and 120 cm | 47.2 in

SAETTA

QUALITY & POWER



The Saetta black is the ultimate in pneumatic spearfishing. An upgraded model of the world-renowned Cressi SL series. The Saetta offers unmatched power, comfort and accuracy. A few design tweaks have been able to maximize shot power with high precision and speed. Among the upgrades of the extremely reliably SL series is a new muzzle with incorporated holes to aid in water drainage and a new, soft, angled white handle that also aids in locating the speargun underwater. The Saetta still boasts some of the same successful features of its

predecessors. For one, an anatomical high grip butt that enables the gun to be held in line with the arm. A strong line hook situated on the bottom of the grip butt for shaft loading. Also a safety catch that frees the line: releasing the device, when the trigger is pulled, and lastly, an Ø 8 mm threaded shaft. The Cressi Saetta is the new standard in pneumatic spearguns. The Saetta is available also with the version with the Power Reducer, a lever that reduces the power of the half, in case of close targets.



CODE	SIZE	STYLE	CASE PACK
FR384000	40 cm	No Power Reducer	6
FR385500	55 cm	No Power Reducer	6
FR387000	70 cm	No Power Reducer	6



CODE	SIZE	STYLE	CASE PACK
F5385500	55 cm	With Power Reducer	6
F5387000	70 cm	With Power Reducer	6
F5388800	88 cm	With Power Reducer	6
F5389910	110 cm	With Power Reducer	6

ACCESSORIES

CODE	PRODUCT
FA390001	MINI SPEAR HEAD
FA390004	MACH SPEAR HEAD 2-FLOPPER
FA390032	PRESSURE GAUGE for SAETTA
FZ370073	HAND PUMP for SAETTA/SAETTA.PRI/SAETTA.PRO
FA354523	SHAFT REFLOATER for PNEUMATIC GUNS

SPARE PARTS

CODE	PRODUCT	GUN LENGTH
FA360036	STAINLESS STEEL THREADED SHAFT Ø 8.0mm (36.5cm)	40 cm
FA361036	STAINLESS STEEL THREADED SHAFT Ø 8.0mm (55cm)	55 cm
FA362036	STAINLESS STEEL THREADED SHAFT Ø 8.0mm (68.5cm)	70 cm
FA363036	STAINLESS STEEL THREADED SHAFT Ø 8.0mm (87.5cm)	90 cm
FA365036	STAINLESS STEEL THREADED SHAFT Ø 8.0mm (99.5cm)	95 cm
FA366036	STAINLESS STEEL THREADED SHAFT Ø 8.0mm (109.5cm)	110 cm

MADE IN ITALY

TECHNICAL FEATURES

- Internal Ø 13 mm barrel
- Power reducer version available
- Safety lock
- Ergonomic handle
- Handle eyelet for cord connection
- Threaded shaft Ø 8.0 mm



The legendary Cressi handle. The angle between barrel and handle determines the winning ergonomics of cressi pneumatic guns



MADE IN ITALY

SL STAR

THE HISTORY OF OUR PNEUMATIC GUNS



The SL Star range of pneumatic spear guns has been in production for many years now, and they have won worldwide fame for their excellence in terms of robustness, reliability, precision and powerful shooting. The various models correspond to the equivalent models in the SL series, without power reducer. Constantly updated over the years, the SL Star spearguns are ultra light, easy to use, and fire quickly. They come with anatomical

high grip butts enabling the gun to be held in line with the arm with no extra effort. The bright yellow butt means you can identify the gun even if it ends up on the sea-bottom after shooting. A strong line hook is situated on the bottom of the butt for shaft loading. The guns are fitted with a safety catch and, when the trigger is pulled, it frees the line releasing device. Stainless steel shafts are available separately.

CODE	SIZE	CASE PACK
FR374000	40 cm	6
FR375500	55 cm	6
FR377000	70 cm	6

ACCESSORIES

CODE	PRODUCT
FA390001	MINI SPEAR HEAD
FA390004	MACH SPEAR HEAD 2-FLOPPER
FA390020	PRESSURE GAUGE for SL/SL STAR
FA320060	HAND PUMP for SL SL STAR
FA354523	SHAFT REFLOATER for PNEUMATIC GUNS

SPARE PARTS

CODE	PRODUCT	GUN LENGTH
FA360036	STAINLESS STEEL THREADED SHAFT Ø 8.0mm (36.5cm)	35 cm
FA361036	STAINLESS STEEL THREADED SHAFT Ø 8.0mm (55cm)	45 cm
FA362036	STAINLESS STEEL THREADED SHAFT Ø 8.0mm (68.5cm)	60 cm

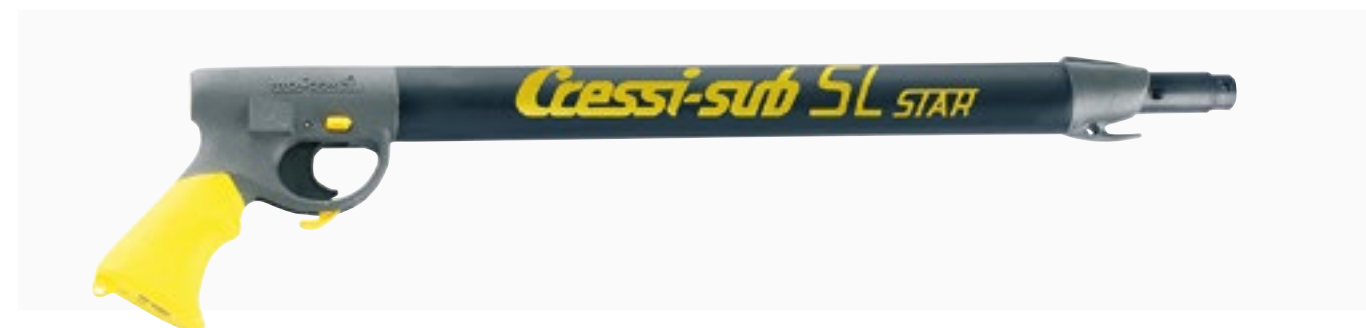

TECHNICAL FEATURES

- Ergonomic handle
- Shaft Ø 8.0 mm
- Safety lock
- Handle eyelet for cord connection



The legendary Cressi handle. The angle between barrel and handle determines the winning ergonomics of cressi pneumatic guns



PNEUMATIC GUN SHAFTS

17-4 PH SHAFT Ø 7.5 mm



DESCRIPTION:
These shafts offer exceptional durability due to the special steel construction.

CODE	GUN LENGTH
FA372000	35 cm
FA373000	45 cm
FA376000	60 cm

PR80 SHAFT Ø 8.0 mm

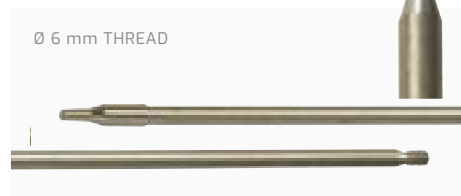

DESCRIPTION:
For Cressi pneumatic spearguns, threaded to fit any Cressi threaded spear tip.

CODE	GUN LENGTH
FA360036	40 cm
FA361036	55 cm
FA362036	70 cm
FA363036	90 cm
FA365036	99.5 cm
FA366036	110 cm

INOX SHAFT Ø 8.0 mm

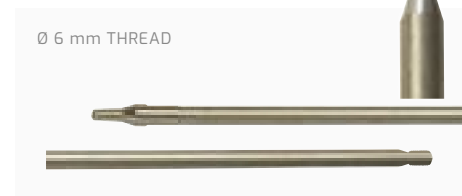

DESCRIPTION:
Tempered steel shaft for Cressi pneumatic spearguns. Threaded to fit any Cressi threaded spear tip.

CODE	GUN LENGTH
FA360030	40 cm
FA360031	55 cm
FA360032	70 cm
FA360033	100 cm
FA360035	110 cm

SPEARHEADS

FOR PNEUMATIC SPEARGUNS

MINI SPEAR HEAD

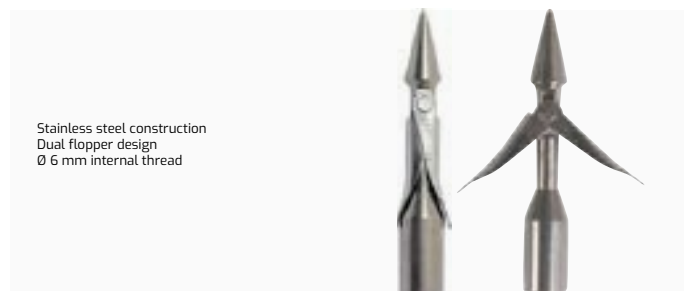

Stainless steel construction
Dual flopper design
Ø 6 mm internal thread

DESCRIPTION:
The Mini Spear Head is a dual flopper. Conical point. Threaded spear tip. Made with corrosion resistant Stainless Steel. The dual flopper setup tucks neatly against the relieved tip for the ultimate in penetration. Yet provides dual floppers for the ultimate in fish holding power. Threaded to fit Pneumatic shafts and threaded Euro shafts.

CODE	PRODUCT
FA390001	MINI SPEAR HEAD
FA390008	3 PRONGS SPEAR HEAD

MACH SPEAR HEAD



Stainless steel construction
Dual flopper design
Ø 6 mm internal thread

DESCRIPTION:
The Mach Spear Head is a dual flopper. Conical point. Threaded spear tip. The Stainless Steel dual flopper setup fold against the tip for the ultimate in penetration. Yet provides dual floppers for the ultimate in fish holding power. Threaded to fit Pneumatic shafts and threaded Euro shafts.

CODE	PRODUCT
FA390004	MACH SPEAR HEAD 2-FLOPPER

SHAFT REFLOATER



CODE
FA354523

SHAFT LOADER



CODE
FA390018

SPEARGUN OIL 100 ml



CODE
FA390022

PRESSURE GAUGE SL • SL STAR

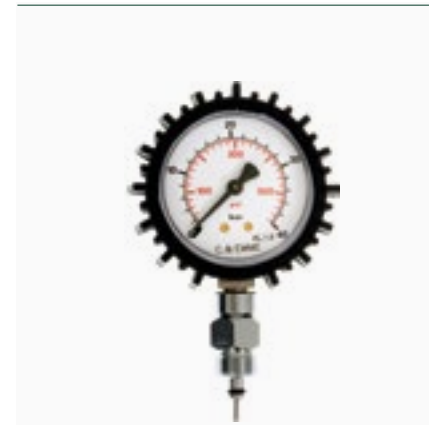

CODE
FA390020

PRESSURE GAUGE SAETTA • SAETTA PRO



CODE
FA390032

HAND PUMP SL • SL STAR

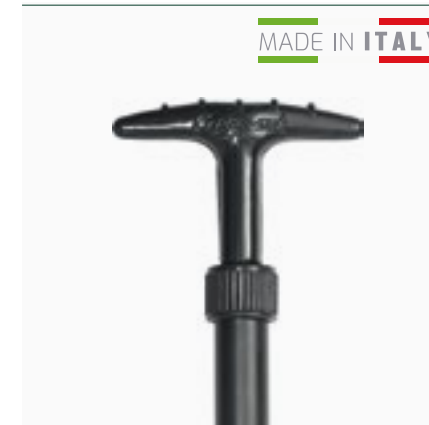

CODE
FA320060

HAND PUMP SAETTA • SAETTA PRO

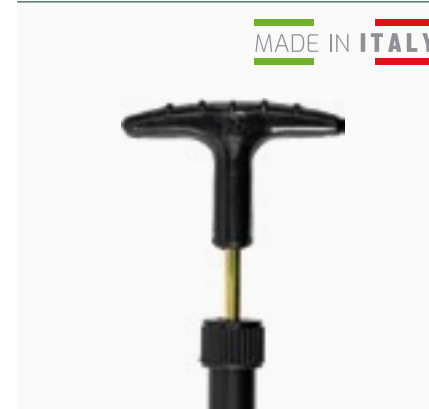

CODE
FZ370073

RUBBER SPEARGUN	GUN DETAILS										SHAFT DETAILS								POWER BAND DETAILS								
	OVERALL LENGTH cm - in	POWER LENGTH cm - in	BARREL Ø mm	SHOT RANGE m - ft	READY TO USE	SHOCK ABSORBER INCLUDED	MUZZLE TYPE	LINE LOOP	SHAFT CODE	MATERIAL	Ø mm	LENGTH cm	FLOPPER TYPE	TAB N°	TAB TYPE	REST TAB	POINT TYPE	COMPATIBLE SHAFTS Ø RANGE mm	COMPATIBLE SHAFTS LENGTHS RANGE cm	BAND CODE	N°	TYPE	MATERIAL	Ø mm	LENGTH mm	WISHBONE	
	CHEROKEE POWER 90																										
	CHEROKEE POWER 100	138 54.3	104 40.9	28	6.9 22.7	no	yes	2x Circular band muzzle	2	FA406120	17-4 PH STAINLESS STEEL	7	120	BOTTOM FLOPPER	2	LARGE SHARKFIN	yes	PIN POINT	from 6 to 7	120/130	FA400524	2x	Circular	Dipped natural latex	16	57	DYNEEMA® SK78
	CHEROKEE POWER 110	148 58.2	114 44.8	28	7.4 24.3	no	yes	2x Circular band muzzle	2	FA406140	17-4 PH STAINLESS STEEL	7	140	BOTTOM FLOPPER	2	LARGE SHARKFIN	yes	PIN POINT	from 6 to 7	140/155	FA400526	2x	Circular	Dipped natural rubber latex	16	69.5	DYNEEMA® SK78
	CHEROKEE POWER 120	158 62.2	124 48.8	28	7.8 25.8	no	yes	2x Circular band muzzle	2	FA406150	17-4 PH STAINLESS STEEL	7	150	BOTTOM FLOPPER	2	LARGE SHARKFIN	yes	PIN POINT	from 6 to 7	150/165	FA400527	2x	Circular	Dipped natural rubber latex	16	77	DYNEEMA® SK78
	CHEROKEE POWER 130	168 66.1	134 52.7	28	8.3 27.4	no	yes	2x Circular band muzzle	2	FA406160	17-4 PH STAINLESS STEEL	7	160	BOTTOM FLOPPER	2	LARGE SHARKFIN	yes	PIN POINT	from 6 to 7	160/175	FA400528	2x	Circular	Dipped natural rubber latex	16	83	DYNEEMA® SK78
	CHEROKEE FAST 75	113 44.4	79 31.1	28	5.5 18.1	no	yes	2x Circular band muzzle	1	FA404903	17-4 PH STAINLESS STEEL	6.5	105	BOTTOM FLOPPER	2	MINI SHARKFIN	no	PIN POINT	from 6 to 7	105/120	FA400483	2x	Circular	Dipped natural rubber latex	14	48	DYNEEMA® SK78
	CHEROKEE FAST 90	128 50.3	94 37.0	28	6.2 20.3	no	yes	2x Circular band muzzle	1	FA404904	17-4 PH STAINLESS STEEL	6.5	120	BOTTOM FLOPPER	2	MINI SHARKFIN	yes	PIN POINT	from 6 to 7	120/135	FA400484	2x	Circular	Dipped natural rubber latex	14	57	DYNEEMA® SK78
	CHEROKEE FAST 100	138 54.3	104 40.9	28	6.6 21.8	no	yes	2x Circular band muzzle	1	FA404905	17-4 PH STAINLESS STEEL	6.5	130	BOTTOM FLOPPER	2	MINI SHARKFIN	yes	PIN POINT	from 6 to 7	130/145	FA400485	2x	Circular	Dipped natural rubber latex	14	63	DYNEEMA® SK78
	CHEROKEE FAST 110	148 58.2	114 44.8	28	7.1 23.3	no	yes	2x Circular band muzzle	1	FA404906	17-4 PH STAINLESS STEEL	6.5	140	BOTTOM FLOPPER	2	MINI SHARKFIN	yes	PIN POINT	from 6 to 7	140/155	FA400486	2x	Circular	Dipped natural rubber latex	14	69.5	DYNEEMA® SK78
	CHEROKEE FAST 120	158 62.2	124 48.8	28	7.5 24.9	no	yes	2x Circular band muzzle	1	FA404907	17-4 PH STAINLESS STEEL	6.5	150	BOTTOM FLOPPER	2	MINI SHARKFIN	yes	PIN POINT	from 6 to 7	150/165	FA400487	2x	Circular	Dipped natural rubber latex	14	77	DYNEEMA® SK78
	CHEROKEE EXO 60	98 38.5	64 25.1	28	4.5 14.9	no	yes	2x Circular band muzzle	1	FA404902	17-4 PH STAINLESS STEEL	6.5	90	BOTTOM FLOPPER	2	MINI SHARKFIN	no	PIN POINT	from 6 to 7	90/105	FA400562	1x	Circular	Dipped natural rubber latex	16	39	DYNEEMA® SK78
	CHEROKEE EXO 75	113 44.4	79 31.1	28	5.2 17.0	no	yes	2x Circular band muzzle	1	FA404903	17-4 PH STAINLESS STEEL	6.5	105	BOTTOM FLOPPER	2	MINI SHARKFIN	no	PIN POINT	from 6 to 7	105/120	FA400563	1x	Circular	Dipped natural rubber latex	16	48	DYNEEMA® SK78
	CHEROKEE EXO 90	128 50.3	94 37.0	28	5.8 19.1	no	yes	2x Circular band muzzle	1	FA404904	17-4 PH STAINLESS STEEL	6.5	120	BOTTOM FLOPPER	2	MINI SHARKFIN	yes	PIN POINT	from 6 to 7	120/135	FA400564	1x	Circular	Dipped natural rubber latex	16	57	DYNEEMA® SK78
	CHEROKEE EXO 100	138 54.3	104 40.9	28	6.2 20.6	no	yes	2x Circular band muzzle	1	FA404905	17-4 PH STAINLESS STEEL	6.5	130	BOTTOM FLOPPER	2	MINI SHARKFIN	yes	PIN POINT	from 6 to 7	130/145	FA400565	1x	Circular	Dipped natural rubber latex	16	63	DYNEEMA® SK78
	CHEROKEE EXO 110	148 58.2	114 44.8	28	6.7 22.0	no	yes	2x Circular band muzzle	1	FA404906	17-4 PH STAINLESS STEEL	6.5	140	BOTTOM FLOPPER	2	MINI SHARKFIN	yes	PIN POINT	from 6 to 7	140/155	FA400566	1x	Circular	Dipped natural rubber latex	16	69.5	DYNEEMA® SK78
	COMANCHE RAIL 60	102 40.1	60 23.6	28	4.3 14.1	yes	no	1X Parallel + 1x Circular band muzzle	1	FA410002	17-4 PH STAINLESS STEEL	6	90	TOP FLOPPER	2	SMOOTH NOTCH	no	PIN POINT	from 6 to 7	90-105	FA400002	1x	Parallel	Synthetic	16	16	jointed-wishbone
	COMANCHE RAIL 75	127 50.0	75 29.5	28	5.3 17.4	yes	no	1X Parallel + 1x Circular band muzzle	1	FA410004	17-4 PH STAINLESS STEEL	6	115	TOP FLOPPER	2	SMOOTH NOTCH	no	PIN POINT	from 6 to 7	105-120	FA400003	1x	Parallel	Synthetic	16	18.5	jointed-wishbone
	COMANCHE RAIL 90	142 55.9	90 35.4	28	5.9 19.4	yes	no	1X Parallel + 1x Circular band muzzle	1	FA410006	17-4 PH STAINLESS STEEL	6	130	TOP FLOPPER	2	SMOOTH NOTCH	yes	PIN POINT	from 6 to 7	120-135	FA400005	1x	Parallel	Synthetic	16	22	jointed-wishbone
	COMANCHE RAIL 100	152 59.8	100 39.3	28	6.3 20.7	yes	no	1X Parallel + 1x Circular band muzzle	1	FA410007	17-4 PH STAINLESS STEEL	6	140	TOP FLOPPER	2	SMOOTH NOTCH	yes	PIN POINT	from 6 to 7	130-145	FA400006	1x	Parallel	Synthetic	16	25.5	jointed-wishbone
	COMANCHE RAIL 110	162 63.7	110 43.3	28	6.7 22.0	yes	no	1X Parallel + 1x Circular band muzzle	1	FA410008	17-4 PH STAINLESS STEEL	6	150	TOP FLOPPER	2	SMOOTH NOTCH	yes	PIN POINT	from 6 to 7	140-155	FA400007	1x	Parallel	Synthetic	16	27.5	jointed-wishbone
	YUMA FAST 60	102 40.1	64 25.1	26	4.3 14.1	no	yes	2x Circular band muzzle	1	FA407090	17-4 PH STAINLESS STEEL	6	90	BOTTOM FLOPPER	2	MINI SHARKFIN	no	PIN POINT	up to 6	90-95	FA400482	1x	Circular	Dipped natural rubber latex	14	39	DYNEEMA® SK78
	YUMA FAST 75	117 46.0	79 31.1	26	4.9 16.1	no	yes	2x Circular band muzzle	1	FA407105	17-4 PH STAINLESS STEEL	6	105	BOTTOM FLOPPER	2	MINI SHARKFIN	no	PIN POINT	up to 6	105-110	FA400483	1x	Circular	Dipped natural rubber latex	14	48	DYNEEMA® SK78
	YUMA FAST 90	132 51.9	94 37.0	26	5.5 18.1	no	yes	2x Circular band muzzle	1	FA407120	17-4 PH STAINLESS STEEL	6	120	BOTTOM FLOPPER	2	MINI SHARKFIN	yes	PIN POINT	up to 6	120-125	FA400484	1x	Circular	Dipped natural rubber latex	14	57	DYNEEMA® SK78
	YUMA FAST 100	142 55.9	104 40.9	26	5.9 19.4	no	yes	2x Circular band muzzle	1	FA407130	17-4 PH STAINLESS STEEL	6	130	BOTTOM FLOPPER	2	MINI SHARKFIN	yes	PIN POINT	up to 6	130-135	FA400485	1x	Circular	Dipped natural rubber latex	14	63	DYNEEMA® SK78
	APACHE 35	67 26.3	30 11.8	28	3.0 10.1	no	no	1x Circular band muzzle	1	FA350535	PR80 GALVANIZED SPRING	7	65	THREAD SPEAR FLOPPER	2	SHARP NOTCH	no	PIN POINT	from 6 to 7	-	FA340019	1x	Circular	Synthetic	13	24	standard-wishbone
	APACHE 45	77 30.3	40 15.7	28	3.4 11.3	no	no	1x Circular band muzzle	1	FA350545	PR80 GALVANIZED SPRING	7	75	THREAD SPEAR FLOPPER	2	SHARP NOTCH	no	PIN POINT	from 6 to 7	-	FA340020	1x	Circular	Synthetic	13	31	standard-wishbone
	APACHE 60	87 34.2	55 21.6	28	3.8 12.6	no	no	1x Circular band muzzle	1	FA350560	PR80 GALVANIZED SPRING	7	85	THREAD SPEAR FLOPPER	2	SHARP NOTCH	no	PIN POINT	from 6 to 7	-	FA340021	1x	Circular	Synthetic	13	34	standard-wishbone
	APACHE 75	102 40.1	70 27.5	28	4.4 14.5	no	no	1x Circular band muzzle	1	FA350575	PR80 GALVANIZED SPRING	7	100	THREAD SPEAR FLOPPER	2	SHARP NOTCH	no	PIN POINT	from 6 to 7	-	FA340022	1x	Circular	Synthetic	13	39	standard-wishbone
	APACHE 90	117 46.0	85 33.4	28	4.9 16.3	no	no	1x Circular band muzzle	1	FA350590	PR80 GALVANIZED SPRING	7	115	THREAD SPEAR FLOPPER	2	SHARP NOTCH	no	PIN POINT	from 6 to 7	-	FA340023	1x	Circular	Synthetic	13	44	standard-wishbone

PNEUMATIC SPEARGUN	GUN DETAILS					EASIER LOADING PRESSURE		STANDARD PRESSURE		HARDER LOADING PRESSURE		SHAFT DETAILS							
	READY TO USE SET	SHOCK ABSORBER INCLUDED	SHOT RANGE m - ft	TOTAL LENGTH GUN + SPEAR cm	BARREL DIAMETER mm	LINE LOOP	bar	psi	bar	psi	bar	psi	MATERIAL	DIAMETER mm	LENGTH cm	FLOPPER TYPE	POINT TYPE	INCLUDED SHAFT SKU	
	SAETTA 40	no	NO	2.4 7.9	70	13	2	16	232	18	261	24	348	PR80 GALVANIZED SPRING	8.0	36.5 (+10)	THREAD SPEAR FLOPPER	PIN POINT	FA360036
	SAETTA 55	no	NO	3.0 9.8	85	13	2	16	232	18	261	24	348	PR80 GALVANIZED SPRING	8.0	55.0 (+10)	THREAD SPEAR FLOPPER	PIN POINT	FA361036
	SAETTA 70	no	NO	3.4 11.4	100	13	2	16	232	18	261	24	348	PR80 GALVANIZED SPRING	8.0	68.5 (+10)	THREAD SPEAR FLOPPER	PIN POINT	FA362036
	SAETTA W/REDUCER 55	no	NO	3.0 9.8	85	13	2	16	232	18	261	24	348	PR80 GALVANIZED SPRING	8.0	55.0 (+10)	THREAD SPEAR FLOPPER	PIN POINT	FA361036
	SAETTA W/REDUCER 70	no	NO	3.4 11.4	100	13	2	16	232	18	261	24	348	PR80 GALVANIZED SPRING	8.0	68.5 (+10)	THREAD SPEAR FLOPPER	PIN POINT	FA362036
	SAETTA W/REDUCER 88	no	NO	4.1 13.5	118	13	2	16	232	18	261	24	348	PR80 GALVANIZED SPRING	8.0	87.5 (+10)	THREAD SPEAR FLOPPER	PIN POINT	FA363036
	SAETTA W/REDUCER 110	no	NO	4.8 15.9	140	13	2	16	232	18	261	24	348	PR80 GALVANIZED SPRING	8.0	109.5 (+10)	THREAD SPEAR FLOPPER	PIN POINT	FA366036
	SL STAR 40	no	NO	2.2 7.3	70	13	2	16	232	18	261	24	348	PR80 GALVANIZED SPRING	8.0	36.5 (+10)	THREAD SPEAR FLOPPER	PIN POINT	FA360036
	SL STAR 55	no	NO	2.7 9.0	85	13	2	16	232	18	261	24	348	PR80 GALVANIZED SPRING	8.0	55.0 (+10)	THREAD SPEAR FLOPPER	PIN POINT	FA361036
	SL STAR 70	no	NO	3.1 10.4	100	13	2	16	232	18	261	24	348	PR80 GALVANIZED SPRING	8.0	68.5 (+10)	THREAD SPEAR FLOPPER	PIN POINT	FA362036

FG1

FIBERGLASS MONO-PIECE POLE SPEAR

The FG1 is the ultimate pole spear made in fiberglass to ensure lightness and speed while underwater. Ideal for traveling and perfect for small to medium size fish. The top ends with a male fitting of 6 mm and two spanner flats that allow tightening using a wrench. It features an elastic rubber band made of OD latex tube with a cord inside installed to the hole. A Paralyzer Tip, composed of 3 tiny barb prongs is included.

CODE	CASE PACK
FP015001	5

FG2

NEW 2023

FIBERGLASS 2-PIECE POLE SPEAR

The FG2 is the ultimate pole spear made in fiberglass to ensure lightness and speed while underwater. Ideal for traveling and perfect for small to medium size fish. The top ends with a male fitting of 6 mm and two spanner flats that allows tightening using a wrench. The pole is 182,5 cm | 72 in long and has a diameter of 13 mm. The rubber sling is made using a Ø 9 mm OD latex tube with a cord inside, installed to the hole. The latex tube length is 76 cm | 30 in, cord length is 22 cm | 8.5 in. Total length of 98 cm | 38.6 in. A Paralyzer Tip, composed of 3 tiny barb prongs, 30.5 cm | 12 in long, is included. Underwater fishing is a way of life and must be done responsibly and sustainably for the environment. Choose your prey well and fish only what is sufficient for feeding yourself, respect nature.

CODE	CASE PACK
FP015002	5

FG3

FIBERGLASS 3-PIECE POLE SPEAR

The FG3 is the ultimate pole spear made in fiberglass to ensure lightness and speed while underwater. Ideal for traveling and perfect for small to medium size fish. The top ends with a male fitting and two spanner flats that allow tightening using a wrench. It's composed of 3 pieces that can be assembled as desired. The threaded tip can accommodate different paralyzed tips.

CODE	CASE PACK
FP015003	5

TECHNICAL FEATURES

- Pole spear made in fiberglass for ensure lightness and speed while underwater.
- The bottom end is rounded with a hole for the rubber sling.
- The top ends with a male fitting of 6 mm and two spanner flats that allows tightening using a wrench.
- The rubber sling is made using a Ø 10 mm OD latex tube with cord inside, installed to the hole.
- Paralyzer tip composed of 3 tiny barb prongs, 25 cm | 10 in long, is included.

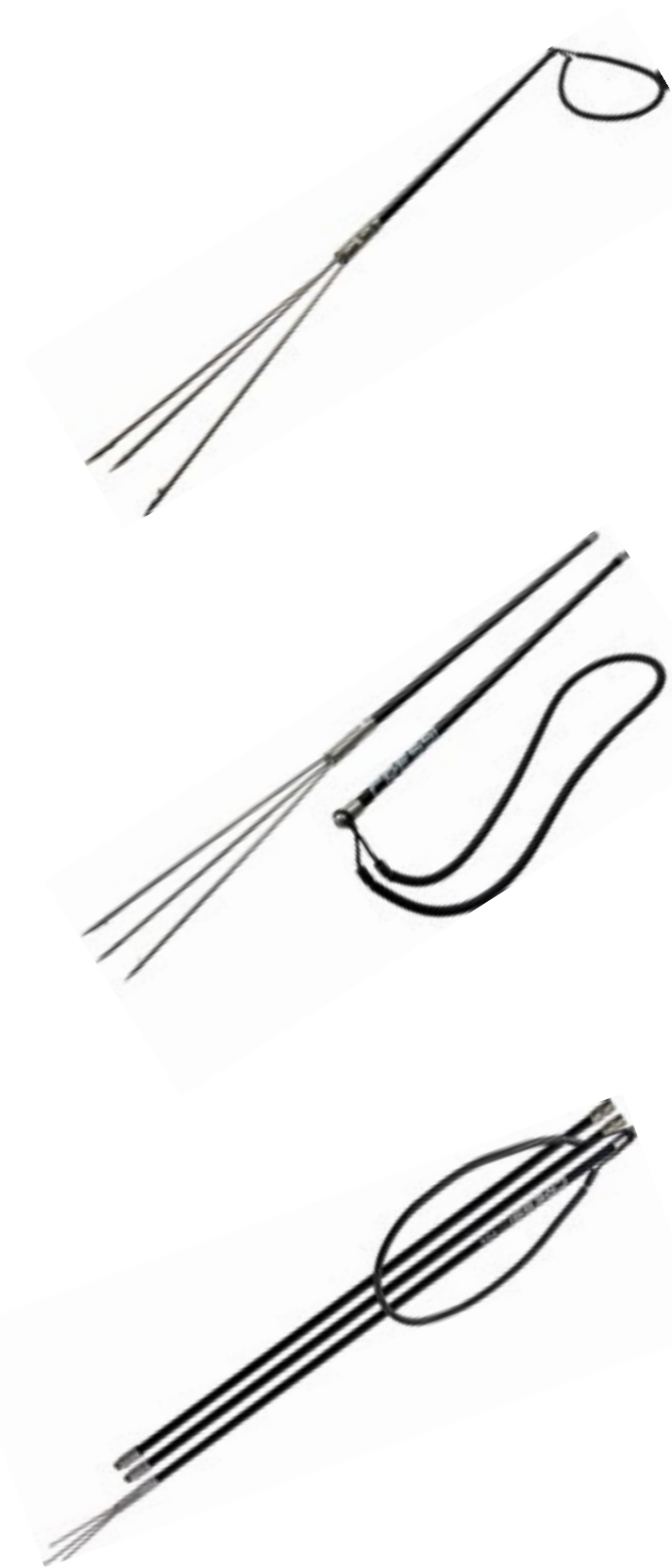

ALUMINUM

ALUMINUM 3-PIECE POLE SPEAR

The Aluminum pole spear is the perfect solution for traveling hunters. Threaded lightweight sections break down to fit in a typical dive bag and can be quickly assembled once at the dive site. Included is a 3-prongs

"Lionfish Cluster" tip and high-quality power band. Other tips are available as accessories, not included. The 3 pieces modular design gives the possibility to choose different assembling for the spearfisherman needs.

TECHNICAL FEATURES

- Thick-walled aluminum construction for durability
- Threaded joints join quickly and securely
- 3-prong lionfish paralyzer tip included



3 PIECES: 6.5 FT LONG FOR NORMAL HUNTING CONDITIONS

2 PIECES: 4.9 FT LONG FOR CLOSE RANGE HUNTING AND LION FISH HUNTING

1 PIECE: 2.7 FT LONG STRICTLY FOR LION FISHES

CODE	SIZE	STYLE	CASE PACK
USX040000	6.5 ft	3 pcs	5

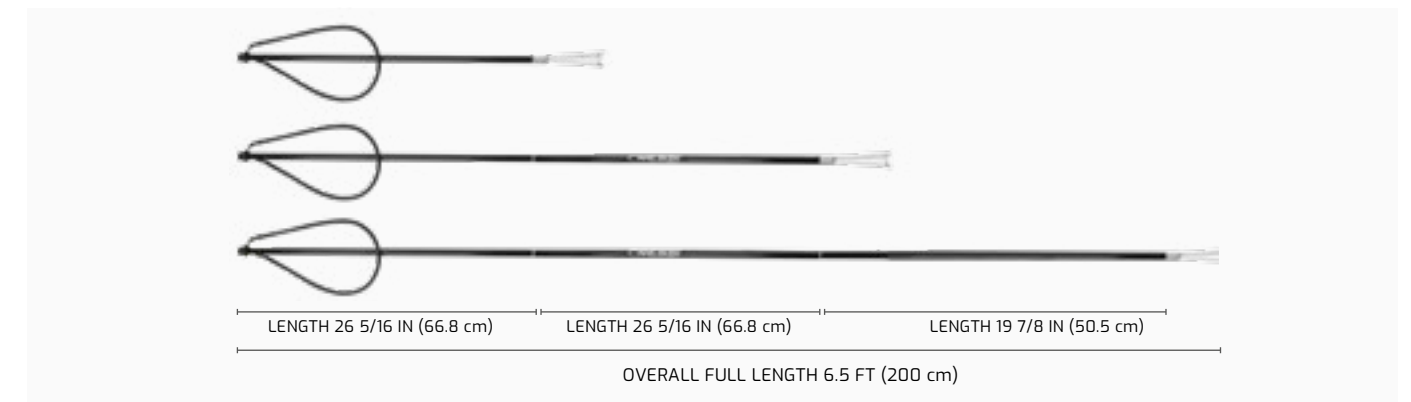

POLE SPEAR ACCESSORIES

FG POLE EXTENSION

CODE	SIZE	COLOR
FZ390155	79 cm	Black

3 BARBLESS PRONGS PARALYZER TIP



DESCRIPTION: 3 Barbless Prongs
 Total length: 14 in - 35.5 cm
 Tip Ø: 5/8 in - 16 mm
 Thread Ø: 15/64 in - 6 mm

CODE
USX020000

5 BARB PRONGS PARALYZER TIP



DESCRIPTION: 5 Barbless Prongs
 Total length: 6 in - 15.2 cm
 Tip Ø: 5/8 in - 16 mm
 Thread Ø: 15/64 in - 6 mm

CODE
FZ390006

POLE SPEAR POWER BAND

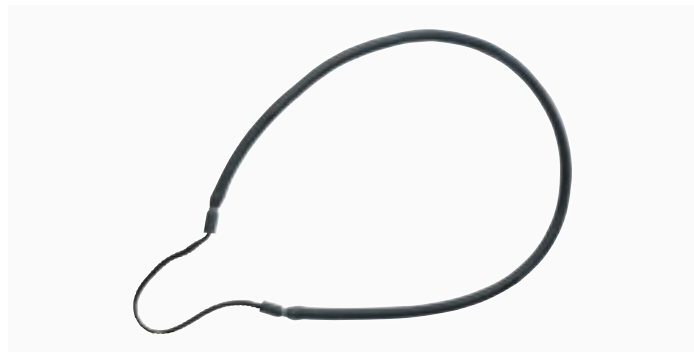

DESCRIPTION:
 Rubber length: 29 1/8 in - 74 cm
 Cord length: 8 5/8 in - 22 cm
 Total length: 37 6/8 in - 96 cm
 Rubber Ø: 3/8 in - 0.9 mm

CODE	SIZE	STYLE
FZ390007	75 cm	Ø 9 mm
FZ390008	115 cm	Ø 9 mm

TIP ADAPTOR 11 MM



DESCRIPTION:
 Inside Ø: 11 mm
 Outer Ø: 6 mm

CODE
USX030000



TORCHES & KNIVES

SPEARFISHING

WHITE COLOR TEMPERATURE | ADJUSTABLE ELASTIC STRAP | EXCELLENT ERGONOMICS | SWITCH WITH 3 POSITIONS | LED LIGHT TECHNOLOGY | PREMIUM MATERIALS | NARROWED LIGHT BEAM

MADE IN ITALY

LUMIA+

ULTRA LED DIVE LAMP

Torch with a highly asymmetric design boasts excellent ergonomics and a highly tactile perception of its geometric characteristics. Thanks to this particular design, the switch position is immediately found without needing to use your eyesight. The porthole and body are coated with thermoplastic rubber to extend shelf life and reduce noises from impact when used for fishing. These ergonomic features are a big advantage over aluminium torches with a circular section which do not give feedback on the position of the grip and, in some cases, even require the use of two hands

to turn it on. The switch has three positions: Off, On Unstable with Automatic Return, On. The "On Unstable" position is particularly useful in fishing because it allows flashing by one simple press. The strap with slider spring allows adjustment according to the user's needs, but being elastic can be pulled out in case of emergency. Power is supplied by four AA batteries, either alkaline or rechargeable. The electronics ensure a constant level of brightness even when the batteries are rechargeable and/or not fully charged. Batteries included.

TECHNICAL FEATURES

- Luminous Flux: 300 Lumens
- Color Temperature: 6500 °K CRI>75
- Burn Time: 3.5 h
- Viewing Angle: 6°
- Illuminance: 30000 Lux
- Impact Resistance: 1.5 m
- Ingress Protection Code: PX-8 75m

NEW WHITE COLOR TEMPERATURE

The LED has a white color temperature similar to sunlight for maximum return of the colors in the underwater environment. The light beam of the LED is narrowed into a spot light beam of about 6° by means of a lens made of ultra-transparent material protected by the polycarbonate optical porthole.

ACTIVE ELECTRONICS

Power is supplied by four AA batteries, either alkaline or rechargeable. The power supply has an electronic management system that eliminates the gap between the different electrical potentials of different types of batteries and ensures an efficiency of 30% higher than the commonly used systems. The active electronics of the flashlight guarantee constant light, even when the battery charge decreases. When the charge drops below the safety threshold value, the lighting level will reduce to warn the user that the batteries are depleted.

Length	168 mm - 6.61 in
Head diameter	47 mm - 1.85 in
Weight	130 g - 4.58 oz (without batteries)

LUMIA+ HIGH RANGE COLOR SPECTRUM



STANDARD LIGHT LIMITED RANGE COLOR SPECTRUM

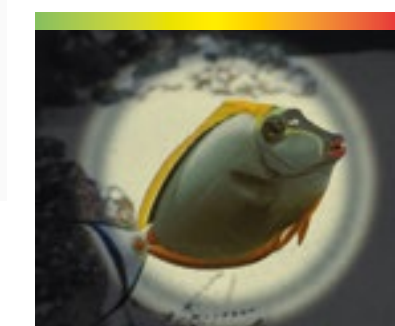

EXCELLENT ERGONOMICS
THANKS TO THERMOPLASTIC
RUBBER COATING AND HIGHLY
ASYMMETRIC DESIGN

SWITCH
WITH 3 POSITIONS
ON | OFF | HOLDING ON
WITH AUTOMATIC RETURN

NARROWED
LIGHT BEAM
APPROXIMATELY 6°
SPOT LIGHT BEAM
THANKS TO TIR LENS

ADJUSTABLE
ELASTIC STRAP
TO CUSTOMISE THE
USE ACCORDING
TO YOUR NEEDS

NEUTRAL WHITE
COLOR TEMPERATURE
SIMILAR TO SUNLIGHT
FOR MAXIMUM RETURN
OF THE COLORS



BLACK/BLACK



BLACK/GREY



CODE	COLOR	CASE PACK
SJ550150	Black/Black	10
SJ550170	Black/Grey	10

ORCA

STAINLESS STEEL



This legendary product has been around for years and years and has now become a sought-after collector's item. It is considerably heavy and large, perfect for a work tool, which this knife is designed to be. The large blade is forged from special steel, with a smooth edge on one side and partly serrated on the other.

CODE	CASE PACK
RC556000	10

Blade length	17,8 cm - 7.0 in
Total length	30 cm - 11.8 in
Blade width	32 mm - 1.25 in
Blade thickness	5,5 mm - 0.22 in
Knife-only weight	450 g - 15.9 oz
Weight with sheath	600 g - 21.2 oz

SPARE PARTS

CODE	PRODUCT
RZ550003	SHEATH W/ STRAPS for ORCA
RZ551007	HOLDER for TOTEM/ORCA
RZ550018	STRAPS for KNIVES (PAIR)

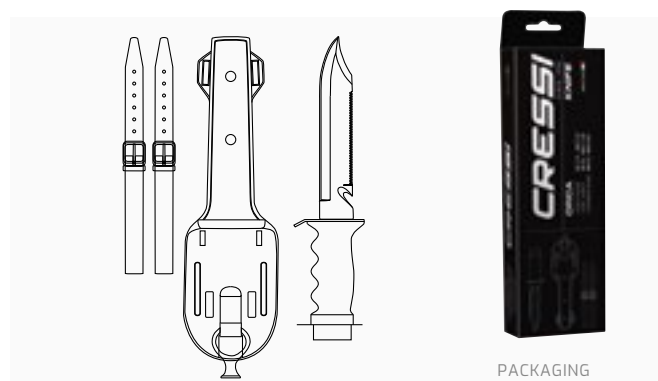

PACKAGING

GIANT

STAINLESS STEEL 304



Knife having large dimensions that make it particularly effective during use. Perfect as a work tool or for particularly intensive use. Made of AISI 420 tempered steel and black coating.

CODE	CASE PACK
RC556500	10

Blade length	17,8 cm - 7.0 in
Total length	30,0 cm - 11.8 in
Blade width	29,7 mm - 1.1 in
Blade thickness	5,2 mm - 0.2 in
Knife-only weight	271 g - 9.6 oz
Weight with sheath	429 g - 15.1 oz

SPARE PARTS

CODE
RZ550015

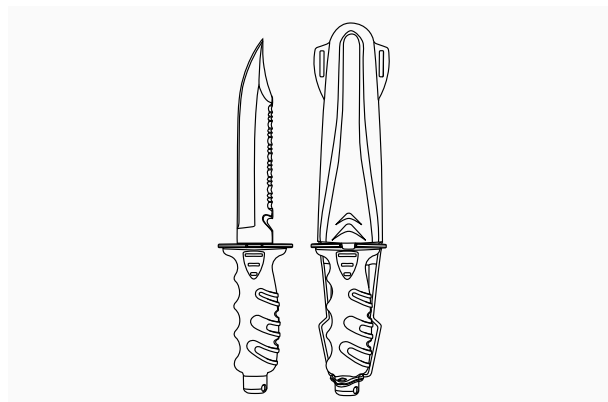

LIZARD

NEW 2023

STAINLESS STEEL



Italian-made professional, multipurpose diver's knife, with blade and handle in w 1.4116 martensitic stainless steel, hardness HRC 55/56, for an extremely sharp and honed blade. A knife with a dagger handle designed specifically for fishing. In the body of the knife a part is intended for the extraction of stranded shafts and for straightening them. The knife can be removed from its sheath quickly and with one hand thanks to a special mechanical system.

CODE	CASE PACK
RC559600	10

TECHNICAL FEATURES

- Made of w 1.4116 martensitic stainless steel, hardness HRC 55/56
- Blade length: 10.5 cm | 4.13 in
- Total length: 21.0 cm | 8.26 in
- Blade thickness: 3.8 mm | 0.15 in

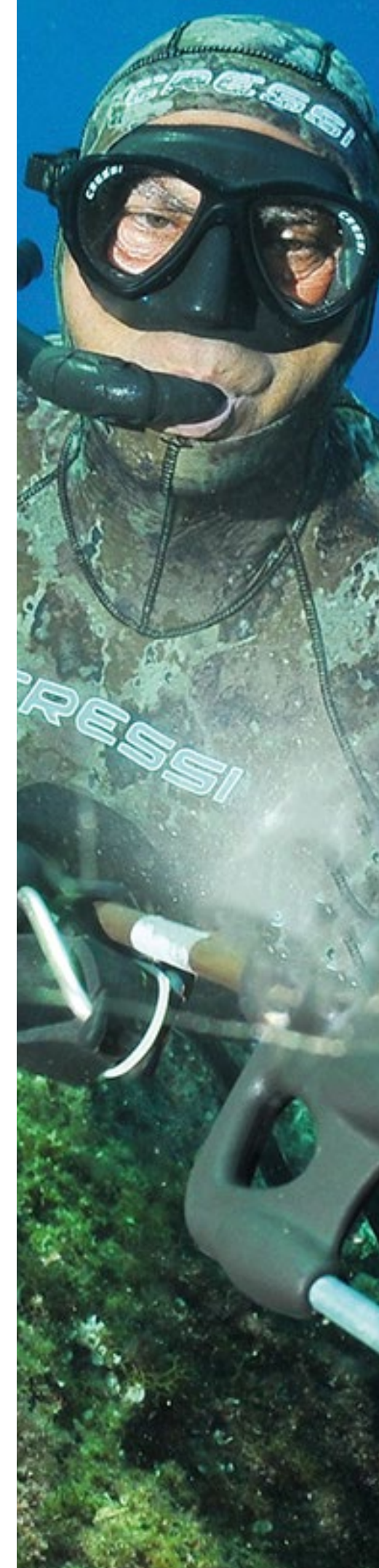

420 JAPANESE 420 STEEL

FINISHER

STAINLESS STEEL



The Finisher is a medium-sized stiletto knife, designed for spearfishing. Handy, great penetration of the blade, resistance, and grip. The blade is extended through the inside of the handle and it has screwed a little pot on the end. It features 420 tempered steel and Black Coating. The blade features one side with a smooth edge and the other with a serrated edge. It has a comfortable grip with a rubbery technopolymer coating and a plastic sheath that is very hydrodynamic with the fixation of the knife by means of a rubber ring.

CODE	CASE PACK
RC559300	10

Blade length	12,7 cm - 5 in
Total length	24,7 cm - 9.7 in
Blade width	17 mm - 0.67 in
Blade thicknesses	3-5 mm - 0.1-0.2 in
Knife-only weight	130 g - 4.6 oz
Weight with sheath	200 g - 7.1 oz

SPARE PARTS

CODE	PRODUCT
RZ550016	SHEATH for FINISHER KNIFE
RZ550018	STRAPS for KNIVES (PAIR)

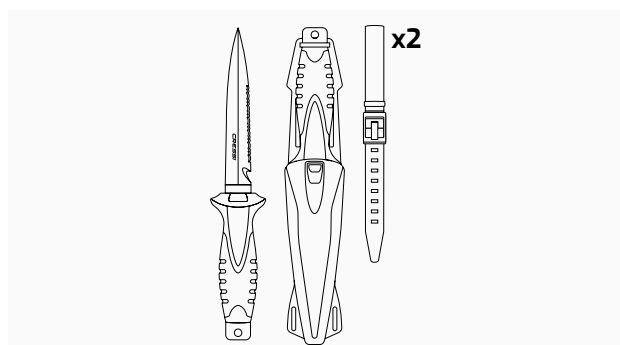

304 JAPANESE STEEL

BORG

STAINLESS STEEL



The Borg is a modern, large knife with a futuristic design and a strong, tempered blade. One side of the stainless steel blade is straight-edged, the other one is serrated right along the blade; they are both very sharp and effective for line cutting. The handle has an ergonomic design to ensure a secure grip even while wearing gloves. It is separated from the blade by a small techno-polymer thumb tab. The knife comes with a sheath that features a locking mechanism to allow one-hand release.

CODE	STYLE	CASE PACK
RC559100	Pointed Tip	10

Blade length	14,0 cm - 5.5 in
Total length	26,5 cm - 10.4 in
Blade width	25 mm - 1 in
Blade thicknesses	5 mm - 0.19 in
Knife-only weight	230 g - 8.1 oz
Weight with sheath	330 g - 11.6 oz

SPARE PARTS

CODE	PRODUCT
RZ550013	SHEATH for BORG KNIFE
RZ550018	STRAPS for KNIVES (PAIR)

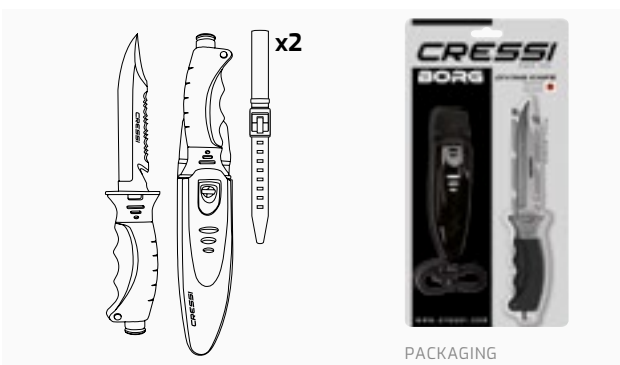

304 JAPANESE STEEL

BORG



The Borg is a modern, large knife with a futuristic design and a strong, tempered blade. One side of the stainless steel blade is straight-edged, the other one is serrated right along the blade; they are both very sharp and effective for line cutting. The handle has an ergonomic design to ensure a secure grip even while wearing gloves. It is separated from the blade by a small techno-polymer thumb tab. The knife comes with a sheath that features a locking mechanism to allow one-hand release.

CODE	STYLE	CASE PACK
RC559150	Blunt Tip	10

Blade length	13,0 cm - 5.0 in
Total length	25,5 cm - 10.0 in
Blade width	25 mm - 1 in
Blade thicknesses	5 mm - 0.19 in
Knife-only weight	230 g - 8.1 oz
Weight with sheath	330 g - 11.6 oz

SPARE PARTS

CODE	PRODUCT
RZ550013	SHEATH for BORG KNIFE
RZ550018	STRAPS for KNIVES (PAIR)

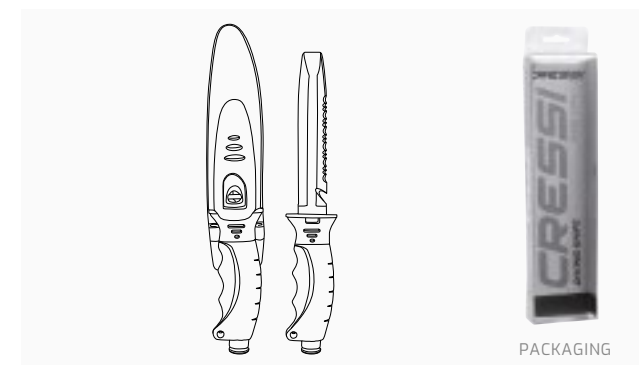

NORGE

STAINLESS STEEL



Norge is a modern, compact knife with a futuristic design and a strong tempered blade. The anatomical, non-slip handle is made from soft grip material. It is separated from the blade by a small technopolymer thumb tab. The blade is made from special tempered stainless steel, with a smooth edge on one side and partly serrated on the other. This side of the blade has a line cutter at the handle end. The black technopolymer sheath comes with loops to attach it to leg or at the waist.

CODE	CASE PACK
RC553010	10

Blade length	11,7 cm - 4.6 in
Total length	22,8 cm - 9.0 in
Blade width	25 mm - 1 in
Blade thicknesses	4,5 mm - 0.18 in
Knife-only weight	140 g - 4.9 oz
Weight with sheath	250 g - 8.8 oz





420 JAPANESE
420 STEEL

MADE IN ITALY

KNIVES / SPEARFISHING CRESSI

PREDATOR

STAINLESS STEEL 420 + COATING



Predator is the evolution of the Killer model, designed to be the perfect finishing knife, very handy and anatomical. Its dimensions make it particularly suitable to be stored as a spare knife, or for divers who like to gear up in a practical and effective way.

CODE	CASE PACK
RC554500	10

Blade length	8,6 cm - 3.4 in
Total length	18,3 cm - 7.2 in
Blade width	17 mm - 0.67 in
Blade thicknesses	3-5 mm - 0.1-0.2 in
Knife-only weight	109 g - 3.8 oz
Weight with sheath	228 g - 8.0 oz

SPARE PARTS

CODE	PRODUCT
RZ550017	SHEATH for PREDATOR KNIFE
RZ550018	STRAPS for KNIVES (PAIR)

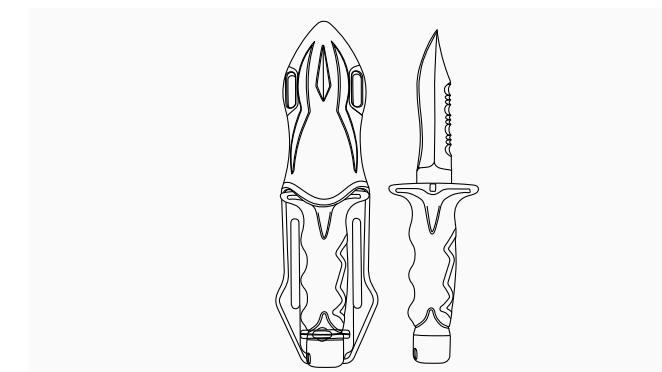

KILLER

STAINLESS STEEL



A small knife that's been around for years now, highly appreciated because it is easy to handle and the blade penetrates really well. This is forged from a single piece of stainless steel, and is blocked at the grip by a screw knob situated at the end of the grip. One side of the blade has a smooth cutting edge, the other is partly serrated. The anatomical technopolymer grip ends at the blade with a thumb tab. The sheath is made from plastic and has a traditional elastic band to hold on the knife and loops to attach the knife to your leg or onto your belt.

CODE	CASE PACK
RC554000	10

Blade length	8,6 cm - 3.4 in
Total length	18 cm - 7.1 in
Blade width	25,2 mm - 1 in
Blade thicknesses	3-5 mm - 0.12-0.2 in
Knife-only weight	120 g - 4.2 oz
Weight with sheath	200 g - 7.1 oz

SPARE PARTS

CODE	PRODUCT
RZ550008	SHEATH W/ STRAPS for KILLER



PACKAGING

SUPERTOTEM

STAINLESS STEEL



An inexpensive, average-size knife with an excellent quality-price ratio. One side of the stainless steel blade is straight-edged, the other one is serrated right along the blade; they are both very sharp and effective for line cutting. The anatomic grip is made from technopolymers and has a series of moulds for the fingers, ending with a thumb protection tab at the blade end. The plastic sheath holds the knife firmly with a traditional elastic band and has loops to attach it to the leg or strap.

CODE	CASE PACK
RC550000	10

Blade length	12,4 cm - 4.9 in
Total length	23,2 cm - 9.1 in
Blade width	32 mm - 1.25 in
Blade thickness	3 mm - 0.12 in
Knife-only weight	120 g - 4.2 oz
Weight with sheath	210 g - 7.4 oz

SPARE PARTS

CODE	PRODUCT
RZ550004	SHEATH W/ STRAPS for SUPERTOTEM
RZ550018	STRAPS for KNIVES (PAIR)

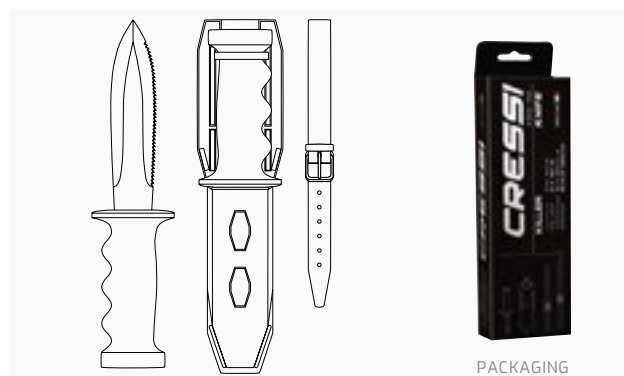

PACKAGING

GRIP

SPEAR TITANIUM



Hose attachment included
BC mount straps included

The Grip Titanium is a small-sized knife with a titanium blade that lasts longer and is easy to use. It's rust-resistant and features a high-precision sharpened tip. One side is an extra-rigid serrated blade for sawing; the other side is a skillfully crafted straight blade. It features an ergonomic non-slip handle grip and a hole to add a lanyard (not included).

CODE	CASE PACK
RC559420	5

Blade length	7,4 cm - 2.9 in
Total length	17,4 cm - 6.8 in
Knife-only weight	35,4 g - 1.2 oz
Weight with sheath	80,7 g - 2.8 oz

SPARE PARTS

CODE	PRODUCT
RZ550022	SHEATH FOR GRIP TITANIUM

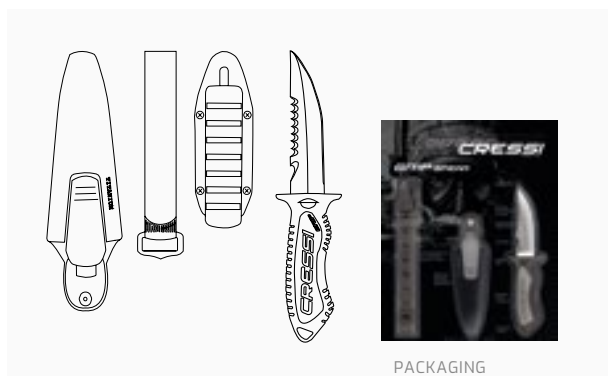

PACKAGING

GRIP

SPEAR



The Grip Spear is a small-sized knife with a tapered blade that makes it ideal for spearfishing. The blade is made of stainless steel. It features a high-precision dagger point tip. One side is an extra-rigid serrated blade for sawing, the other side is a skillfully crafted straight blade. It features an ergonomic non-slip handle grip and a hole to add a lanyard (not included). The knife comes with a sheath that can be attached to the BCD shoulder strap.

CODE	CASE PACK
RC559400	5

Blade length	8,1 cm - 3.1 in
Total length	17,4 cm - 6.8 in
Knife-only weight	49 g - 1.7 oz
Weight with sheath	85 g - 3.0 oz

SPARE PARTS

CODE	PRODUCT
RZ550021	SHEATH FOR GRIP SPEAR

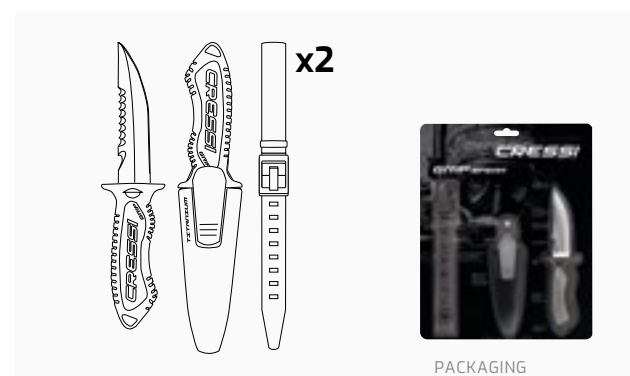

PACKAGING

GRIP

SPEAR BLACK

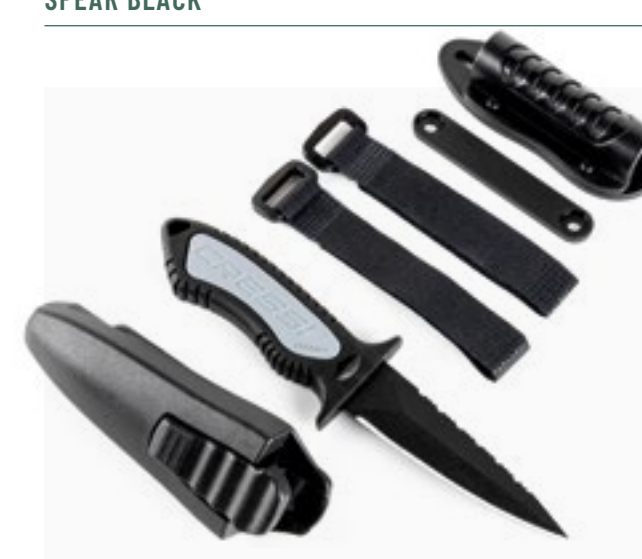

The Grip Spear Black is a small-sized knife with a special blade with two edges; ideal for any dives. The blade is made with the Japanese 420 Stainless Steel: strong and rust resistant. It features a high precision Dagger point tip. One side is an extra rigid serrated blade for sawing, the other side is a skillfully crafted straight blade. It features an ergonomic non-slip handle grip and a hole to add a lanyard (not included). The knife comes with a sheath that can be attached at the BCD shoulder strap. It has a Lock Mechanism that secures the knife. With 2 rubber straps (included) you can fix the sheath at your leg or at you arm.

CODE	CASE PACK
RC559430	5

Blade length	7,6 cm - 3.0 in
Total length	17,4 cm - 6.8 in
Knife-only weight	51 g - 1.8 oz
Weight with sheath	88 g - 3.1 oz

SPARE PARTS

CODE	PRODUCT
RZ550021	SHEATH FOR GRIP SPEAR

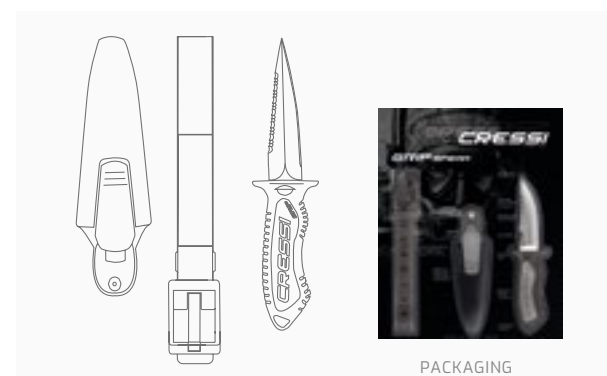

PACKAGING

SKORPION

| STAINLESS STEEL



Skorpion is a modern knife of last generation design and of medium dimensions, with a resistant tempered blade of tempered AISI 304 steel, with a smooth edge and a serrated edge with a wire cutter incorporated. The handle is anatomically shaped and made of "soft grip" material for a secure grip. It is separated from the blade by an integrated handguard made of technopolymer. Includes a pot in the same material as the leaf. The cover is made of black technopolymer and has straps for fixing to the thigh or belt. The knife comes with a sheath that features a locking mechanism to allow one-hand release. The sheath comes with two, standard issue straps to attach it to your leg.

CODE	STYLE
RC559000	Steel Blade
XRC569050	Black Blade

Blade length	11 cm - 4.3 in
Total length	23.2 cm - 9.1 in
Blade width	25.5 mm - 1 in
Blade thickness	5 mm - 0.18 in
Knife-only weight	200 g - 7.1 oz
Weight with sheath	280 g - 9.9 oz

SPARE PARTS

CODE	PRODUCT
RZ550014	SHEATH for SKORPION KNIFE
RZ550018	STRAPS for KNIVES (PAIR)



PACKAGING

VIGO

STAINLESS STEEL



Versatile knife featuring a blade made from stainless steel specifically made for the marine environment. Sheath with locking mechanism to allow one-hand release. The knife comes with two, standard issue straps to attach it to your leg.

CODE	CASE PACK
RC555000	10

Blade length	11,8 cm - 4.6 in
Total length	23,5 cm - 9.2 in
Blade width	25,2 mm - 1 in
Blade thickness	5 mm - 0.19 in
Knife-only weight	147 g - 5.2 oz
Weight with sheath	217 g - 7.6 oz



PACKAGING

KNIVES SPARE PARTS

CODE	PRODUCT
RZ550003	SHEATH W/ STRAPS for ORCA
RZ550004	SHEATH W/ STRAPS for SUPERTOTEM
RZ550010	SHEATH for LAMA ARA KNIFE
RZ550012	SHEATH for LIMA KNIFE
RZ550013	SHEATH for BORG KNIFE
RZ550014	SHEATH for SKORPION KNIFE
RZ550015	SHEATH for GIANT KNIFE
RZ550016	SHEATH for FINISHER KNIFE
RZ550017	SHEATH for PREDATOR KNIFE
RZ550018	STRAPS for KNIVES (PAIR)
RZ550019	SHEATH FOR ALLIGATOR
RZ550020	SHEATH FOR GRIP BLUNT
RZ550021	SHEATH FOR GRIP SPEAR
RZ550022	SHEATH FOR GRIP TITANIUM
RZ551007	HOLDER for TOTEM/ORCA

KNIVES COMPARISON CHART

product	blade length	total length	blade width	blade thickness	knife-only weight	weight with sheath
orca	17,8 cm 7.0 in	30 cm 11.82 in	32 mm 1.25 in	5,5 mm 0.22 in	450 g 15.9 oz	600 g 21.2 oz
giant	17,8 cm 7.0 in	30,0 cm 11.8 in	29,7 mm 1.1 in	5,2 mm 0.2 in	271 g 9.6 oz	429 g 15.1 oz
finisher	12,7 cm 5.0 in	24,7 cm 9.7 in	17 mm 0.67 in	3-5 mm 0.1-0.2 in	130 g 4.6 oz	200 g 7.1 oz
BORG Pointed Tip	14,0 cm 5.5 in	26,5 cm 10.4 in	25 mm 1 in	5 mm 0.19 in	230 g 8.1 oz	330 g 11.6 oz
BORG Blunt Tip	13,0 cm 5.0 in	25,5 cm 5.0 in	25 mm 1 in	5 mm 0.19 in	230 g 8.1 oz	330 g 11.6 oz
norge	11,7 cm 4.6 in	22,8 cm 9.0 in	25 mm 1 in	4,5 mm 0.18 in	140 g 4.9 oz	250 g 8.8 oz
KAI	10 cm 3.9 in	23 cm 9 in	30 mm 1.2 in	4 mm 0.15 in	140 g 4.9 oz	180 g 6.3 oz
KAI MINI	4,5 cm 1.77 in	11 cm 4.33 in	30 mm 1.2 in	4 mm 0.15 in	65 g 2.3 oz	90 g 3.2 oz
predator	8,6 cm 3.4 in	18,3 cm 7.2 in	17 mm 0.67 in	3-5 mm 0.1-0.2 in	109 g 3.8 oz	228 g 8.0 oz
killer	8,6 cm 3.4 in	18 cm 7.1 in	25,2 mm 1 in	3-5 mm 0.1-0.2 in	120 g 4.2 oz	200 g 7.1 oz
supertotem	12,4 cm 4.9 in	23,2 cm 9.1 in	32 mm 1.25 in	3 mm 0.12 in	120 g 4.2 oz	210 g 7.4 oz
grip Point Tip	8,1 cm 3.1 in	17,4 cm 6.8 in	n/a	n/a	49 g 1.7 oz	85 g 3.0 oz
skorpion	11 cm 4.3 in	23,2 cm 9.1 in	25,5 mm 1 in	5 mm 0.18 in	200 g 7.1 oz	280 g 9.9 oz
vigo	11,8 cm 4.6 in	23,5 cm 9.2 in	25,2 mm 1 in	5 mm 0.19 in	147 g 5.2 oz	217 g 7.6 oz

BRAND SUPPORT

FULL FACE MASK METAL SLATWALL DISPLAY



CODE
VAEDUKE

MASK ACRYLIC SLATWALL DISPLAY



CODE
VAEMASK

SNORKEL ACRYLIC SLATWALL DISPLAY



CODE
VAESNOR

FLAT ACRYLIC SLATWALL DISPLAY



CODE
VAEFLAT

WRIST COMPUTER DISPLAY
ACRYLIC TABLE TOP DISPLAY



CODE
VAEUATT

WRIST COMPUTER DISPLAY
METAL SLATWALL DISPLAY



CODE
VAEUMWC

REGULATOR DISPLAY
METAL SLATWALL DISPLAY



CODE
VAEUMWR

CONSOLE DISPLAY
METAL SLATWALL DISPLAY



CODE
VAEUMWD

HOOK FOR WETSUITS



CODE
VAEWETSUIT

HOOK FOR FINS



CODE
VAEFINS

SLATWALL METAL FACEOUT



CODE
VAEWAGF

MOBILE METAL STAND DISPLAY



CODE
VAEMOMS

BLUE FLAG



70 X 45 CM | 27.6 X 17.7 IN

30 X 20 CM | 11.8 X 7.9 IN

CODE	COLOR	SIZE
VABANB05	Blue	70 x 45 cm 27.6 x 17.7 in
VABANB06	Blue	30 x 20 cm 11.8 x 7.9 in

DIVE CENTER FLAG



100 X 70 CM | 39.4 X 27.6 IN

70 X 45 CM | 27.6 X 17.7 IN

30 X 20 CM | 11.8 X 7.9 IN

CODE	COLOR	SIZE
VABANB11	White	100 x 70 cm 39.4 x 27.6 in
VABANB15	White	70 x 45 cm 27.6 x 17.7 in
VABANB16	White	30 x 20 cm 11.8 x 7.9 in

FEATHER

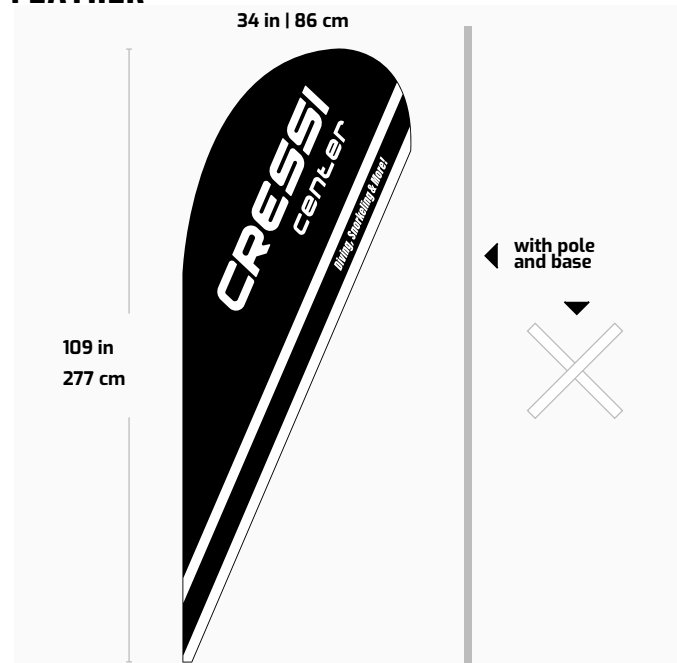

CODE

VABANOUT



STICKERS



sticker
Back adhesive side

Small	10 x 9,1 cm
	3.94 x 3.58 in
Regular	30 x 27 cm
	11.8 x 10.6 in
Big	58,5 x 53 cm
	23 x 20.8 in

CODE	SIZE
VPADE5210	Small
VPADE5010	Regular
VPADE5110	Big



sticker
Back adhesive side

Small	15 x 15,3 cm
	5.9 x 6 inch
Regular	30 x 30,5 cm
	11.8 x 12 inch

CODE	SIZE
VPADE5011	Small
VPADE5211	Regular



sticker
Back adhesive side

Size	48 x 21,1 cm
	18.9 x 8.3 inch

CODE

VPADE5012

HOODIE

85% ORGANIC COTTON | 15% POLYESTER 300 GSM



CODE	SIZE
VA945202	S
VA945203	M
VA945204	L
VA945205	XL
VA945206	2XL
VA945207	3XL

METAL DISPLAY

40 SUNGLASSES [10+10+10+10]



CODE
XVAESUNG



SPARE PARTS

BOON!



OPTICAL LENSES

FOCUS

The Optical Lens are sold individually. The Focus lenses can be mounted both for left and right.

PLEASE ALSO REFER TO THE CRESSI SPARE PARTS CATALOG FOR FURTHER INFORMATION AND TECHNICAL DETAILS

CODE	PRODUCT
NEW 23 DI240110	BIFOCAL OPTICAL LENS +1.0 (LEFT) for FOCUS
NEW 23 DI240115	BIFOCAL OPTICAL LENS +1.5 (LEFT) for FOCUS
NEW 23 DI240120	BIFOCAL OPTICAL LENS +2.0 (LEFT) for FOCUS
NEW 23 DI240125	BIFOCAL OPTICAL LENS +2.5 (LEFT) for FOCUS
NEW 23 DI240130	BIFOCAL OPTICAL LENS +3.0 (LEFT) for FOCUS
NEW 23 DI240135	BIFOCAL OPTICAL LENS +3.5 (LEFT) for FOCUS
NEW 23 DI240140	BIFOCAL OPTICAL LENS +4.0 (LEFT) for FOCUS
NEW 23 DI240210	BIFOCAL OPTICAL LENS +1.0 (RIGHT) for FOCUS
NEW 23 DI240215	BIFOCAL OPTICAL LENS +1.5 (RIGHT) for FOCUS
NEW 23 DI240220	BIFOCAL OPTICAL LENS +2.0 (RIGHT) for FOCUS
NEW 23 DI240225	BIFOCAL OPTICAL LENS +2.5 (RIGHT) for FOCUS
NEW 23 DI240230	BIFOCAL OPTICAL LENS +3.0 (RIGHT) for FOCUS
NEW 23 DI240235	BIFOCAL OPTICAL LENS +3.5 (RIGHT) for FOCUS
NEW 23 DI240240	BIFOCAL OPTICAL LENS +4.0 (RIGHT) for FOCUS
DI240010	OPTICAL LENS -1.0 for FOCUS
DI240015	OPTICAL LENS -1.5 for FOCUS
DI240020	OPTICAL LENS -2.0 for FOCUS
DI240025	OPTICAL LENS -2.5 for FOCUS
DI240030	OPTICAL LENS -3.0 for FOCUS
DI240035	OPTICAL LENS -3.5 for FOCUS
DI240040	OPTICAL LENS -4.0 for FOCUS
DI240045	OPTICAL LENS -4.5 for FOCUS
DI240050	OPTICAL LENS -5.0 for FOCUS
DI240055	OPTICAL LENS -5.5 for FOCUS
DI240060	OPTICAL LENS -6.0 for FOCUS
DI240065	OPTICAL LENS -6.5 for FOCUS
DI240070	OPTICAL LENS -7.0 for FOCUS
DI240075	OPTICAL LENS -7.5 for FOCUS
DI240080	OPTICAL LENS -8.0 for FOCUS

BIG EYES EVOLUTION & QUANTUM

PLEASE ALSO REFER TO THE CRESSI SPARE PARTS CATALOG FOR FURTHER INFORMATION AND TECHNICAL DETAILS

CODE	PRODUCT
NEW 23 DI335010	BIFOCAL OPTICAL LENS +1.0 (RIGHT) for BIG EYES EVO/QUANTUM
NEW 23 DI335015	BIFOCAL OPTICAL LENS +1.5 (RIGHT) for BIG EYES EVO/QUANTUM
NEW 23 DI335020	BIFOCAL OPTICAL LENS +2.0 (RIGHT) for BIG EYES EVO/QUANTUM
NEW 23 DI335025	BIFOCAL OPTICAL LENS +2.5 (RIGHT) for BIG EYES EVO/QUANTUM
NEW 23 DI335030	BIFOCAL OPTICAL LENS +3.0 (RIGHT) for BIG EYES EVO/QUANTUM
DI336010	OPTICAL LENS - 1.0 (RIGHT) for BIG EYES EVO/QUANTUM
DI336015	OPTICAL LENS - 1.5 (RIGHT) for BIG EYES EVO/QUANTUM
DI336020	OPTICAL LENS - 2.0 (RIGHT) for BIG EYES EVO/QUANTUM
DI336025	OPTICAL LENS - 2.5 (RIGHT) for BIG EYES EVO/QUANTUM
DI336030	OPTICAL LENS - 3.0 (RIGHT) for BIG EYES EVO/QUANTUM
DI336035	OPTICAL LENS - 3.5 (RIGHT) for BIG EYES EVO/QUANTUM
DI336040	OPTICAL LENS - 4.0 (RIGHT) for BIG EYES EVO/QUANTUM
DI336045	OPTICAL LENS - 4.5 (RIGHT) for BIG EYES EVO/QUANTUM
DI336050	OPTICAL LENS - 5.0 (RIGHT) for BIG EYES EVO/QUANTUM
DI336055	OPTICAL LENS - 5.5 (RIGHT) for BIG EYES EVO/QUANTUM
DI336060	OPTICAL LENS - 6.0 (RIGHT) for BIG EYES EVO/QUANTUM
NEW 23 DI335110	BIFOCAL OPTICAL LENS +1.0 (LEFT) for BIG EYES EVO/QUANTUM
NEW 23 DI335115	BIFOCAL OPTICAL LENS +1.5 (LEFT) for BIG EYES EVO/QUANTUM
NEW 23 DI335120	BIFOCAL OPTICAL LENS +2.0 (LEFT) for BIG EYES EVO/QUANTUM
NEW 23 DI335125	BIFOCAL OPTICAL LENS +2.5 (LEFT) for BIG EYES EVO/QUANTUM
NEW 23 DI335130	BIFOCAL OPTICAL LENS +3.0 (LEFT) for BIG EYES EVO/QUANTUM
DI336110	OPTICAL LENS - 1.0 (LEFT) for BIG EYES EVO/QUANTUM
DI336115	OPTICAL LENS - 1.5 (LEFT) for BIG EYES EVO/QUANTUM
DI336120	OPTICAL LENS - 2.0 (LEFT) for BIG EYES EVO/QUANTUM
DI336125	OPTICAL LENS - 2.5 (LEFT) for BIG EYES EVO/QUANTUM
DI336130	OPTICAL LENS - 3.0 (LEFT) for BIG EYES EVO/QUANTUM
DI336135	OPTICAL LENS - 3.5 (LEFT) for BIG EYES EVO/QUANTUM
DI336140	OPTICAL LENS - 4.0 (LEFT) for BIG EYES EVO/QUANTUM
DI336145	OPTICAL LENS - 4.5 (LEFT) for BIG EYES EVO/QUANTUM
DI336150	OPTICAL LENS - 5.0 (LEFT) for BIG EYES EVO/QUANTUM
DI336155	OPTICAL LENS - 5.5 (LEFT) for BIG EYES EVO/QUANTUM
DI336160	OPTICAL LENS - 6.0 (LEFT) for BIG EYES EVO/QUANTUM

BIG EYES

PLEASE ALSO REFER TO THE CRESSI SPARE PARTS CATALOG FOR FURTHER INFORMATION AND TECHNICAL DETAILS

CODE	PRODUCT
DI260010	OPTICAL LENS -1.0 (RIGHT) for BIG EYES
DI260015	OPTICAL LENS -1.5 (RIGHT) for BIG EYES
DI260020	OPTICAL LENS -2.0 (RIGHT) for BIG EYES
DI260025	OPTICAL LENS -2.5 (RIGHT) for BIG EYES
DI260030	OPTICAL LENS -3.0 (RIGHT) for BIG EYES
DI260035	OPTICAL LENS -3.5 (RIGHT) for BIG EYES
DI260040	OPTICAL LENS -4.0 (RIGHT) for BIG EYES
DI260045	OPTICAL LENS -4.5 (RIGHT) for BIG EYES
DI260050	OPTICAL LENS -5.0 (RIGHT) for BIG EYES
DI260055	OPTICAL LENS -5.5 (RIGHT) for BIG EYES
DI260060	OPTICAL LENS -6.0 (RIGHT) for BIG EYES
DI260110	OPTICAL LENS -1.0 (LEFT) for BIG EYES
DI260115	OPTICAL LENS -1.5 (LEFT) for BIG EYES
DI260120	OPTICAL LENS -2.0 (LEFT) for BIG EYES
DI260125	OPTICAL LENS -2.5 (LEFT) for BIG EYES
DI260130	OPTICAL LENS -3.0 (LEFT) for BIG EYES
DI260135	OPTICAL LENS -3.5 (LEFT) for BIG EYES
DI260140	OPTICAL LENS -4.0 (LEFT) for BIG EYES
DI260145	OPTICAL LENS -4.5 (LEFT) for BIG EYES
DI260150	OPTICAL LENS -5.0 (LEFT) for BIG EYES
DI260155	OPTICAL LENS -5.5 (LEFT) for BIG EYES
DI260160	OPTICAL LENS -6.0 (LEFT) for BIG EYES

MADE IN ITALY

FULL FACE MASK PARTS

Please also refer to the Cressi Spare Parts Catalog for further information and Technical Details

CODE	PRODUCT
XDZ500001	Duke Dry Complete Snorkel - Clear/Grey
XDZ500002	Duke Dry Complete Snorkel - Black/Grey
XDZ500009	Duke Dry Mouthpiece Cover - Black
XDZ500010	Duke Dry Mouthpiece Cover - Grey
XDZ500011	Duke Dry Strap - Black-White/Silver
XDZ500012	Valves Kit For Duke
XDZ500300	Baron Jr Complete Snorkel - Clear/Clear

MASK PARTS

Please also refer to the Cressi Spare Parts Catalog for further information and Technical Details

CODE	PRODUCT
DZ210005	Buckles - Black (Pair) For Onda/Ondina/Perla/Plumetta/Sirena
DZ210020	Buckles - Black For Marea/Marea Jr/Sky/Sky Jr/Ocean
DZ210040	Silicone Strap - Clear For Sea Line Masks
DZ210042	Silicone Strap - Black For Sea Line Masks
DZ221000	Buckles For Scuba Mask Tw - Black/Clear
DZ221030	Buckles For Scuba Mask Tw - White/Clear
DZ221040	Buckles For Scuba Mask Tw - Pink/Clear
DZ221050	Buckles For Scuba Mask Tw - Black/Black
DZ222000	Strap For Scuba Mask Tw - Clear
DZ222030	Strap For Scuba Mask Tw - White
DZ222040	Strap For Scuba Mask Tw - Pink
DZ222050	Strap For Scuba Mask Tw - Black
DZ215005	Silicone Strap - Clear For Big Eyes/Focus
DZ215006	Silicone Strap - Black For Big Eyes/Focus
DZ210008	Buckles - Black For Big Eyes
DZ210010	Buckles - Black For Focus/Sky
DZ215007	Strap Loop Large For Focus/Big Eyes - Clear (Pair)
DZ260030	Strap + Retainers - White For Pegaso
DZ271030	Buckles - Yellow/White For Pegaso
DZ272030	Buckles - Blue/White For Pegaso
DZ274130	Buckles - Lilac/White For Pegaso

FINS PARTS

Please also refer to the Cressi Spare Parts Catalog for further information and Technical Details

CODE	PRODUCT
BZ170003	Fin Strap For Palau Fins
BZ170004	Buckles For Palau Fins
CZ242030	Strap & Buckles Assembly - Blue/White For Mini Bonete/Rocks
CZ244130	Strap & Buckles Assembly - Lilac/White For Bonete/Rocks
USZ100020	Strap & Buckles Assembly - Black/Blue For Bonete
USZ100041	Strap & Buckles Assembly - Black/Purple For Bonete
USZ100050	Strap & Buckles Assembly - Black/Black For Bonete

SNORKEL PARTS

Please also refer to the Cressi Spare Parts Catalog for further information and Technical Details

CODE	PRODUCT
EZ267004	Snorkel Keeper For America/Top - Black
EZ267005	Snorkel Keeper For Corsica/Mexico/Gamma - Black
EZ267009	Snorkel Keeper For Corsica/Mexico/Gamma - Clear
EZ267011	Snorkel Keeper For Top - Clear
EZ267015	Snorkel Keeper For Alpha Ultra Dry/Beta - Grey
EZ267018	Snorkel Keeper For Supernova Dry/Tao/Tao Dry - Black
EZ267018W	Snorkel Keeper For Supernova Dry/Tao/Tao Dry - White
EZ270017	Mouthpiece For Alpha Ultra Dry/Beta - Black
EZ267019	Snorkel Keeper For Minidry - White
EZ267019B	Snorkel Keeper For Minidry - Black
EZ269030	Snorkel Keeper - White For Iguana/Iguana Dry
EZ270019	Mouthpiece For Alpha Ultra Dry/Beta - Clear
EZ270022	Mouthpiece For Supernova Dry/Tao/Tao Dry - Black
EZ270024	Mouthpiece For Supernova Dry/Tao/Tao Dry - Clear
EZ270026	Mouthpiece For Mini Dry - Clear
EZ270029	Mouthpiece For Mexico/Corsica - Black
EZ270031	Mouthpiece For Mexico/Corsica - Clear
EZ270036	Mouthpiece For Top - Clear
EZ270039	Mouthpiece For Tao Dry - Yellow
EZ270040	Mouthpiece For Tao Dry - Blue
EZ270041	Mouthpiece For Tao Dry - Pink
EZ270044	Mouthpiece For Tao Dry - Lilac
EZ271020	Mouthpiece - Clear/Blue For Iguana/Iguana Dry
EZ271041	Mouthpiece - Clear/Lilac For Iguana/Iguana Dry
USZ631000	Mouthpiece - Island Snorkel

SWIM GOGGLES PARTS

Please also refer to the Cressi Spare Parts Catalog for further information and Technical Details

CODE	PRODUCT
DZ300006	Strap For Minima/Galileo - Clear
DZ300050	Buckles (Black) For Swim Goggles
DZ300060	Buckles (Clear) For Swim Goggles
DZ301020	Swim Goggles Silicone Strap - Blue
DZ301030	Swim Goggles Silicone Strap - White
DZ301040	Swim Goggles Silicone Strap - Pink
DZ301041	Swim Goggles Silicone Strap - Lilac
DZ301050	Swim Goggles Silicone Strap - Black
DZ301051	Swim Goggles Silicone Strap - Grey
DZ301060	Swim Goggles Silicone Strap - Clear

CODE	PRODUCT
XKZ000001	Manta Battery Kit W/O-Ring (Renata 371 - 36.0 X Ø 0.8 Mm)
KZ764788	Watchstrap - Red For Manta

DIMENSION CHARTS

BAGS DIMENSION CHART

	DIMENSION (LENGTH-WIDTH-HEIGHT)		VOLUME		WEIGHT	
	CENTIMETER	INCH	LITER	CU FT	KG	LB
JUMBO	50 x 35 x 80 h	19 3/4 x 13 3/4 x 31 1/2	140	4.90	4.5 kg	9 lb 15 oz
MOBY 5	40 x 28 x 76 h	15 1/2 x 11 x 30 h	115	4.06	3.9 kg	8 lb 10 oz
MOBY 5 HYDRO	40 x 28 x 76 h	15 1/2 x 11 x 30 h	115	4.06	5.1 kg	11 lb 4 oz
GORILLA PRO XL	95 x 34 x 42 h	37 x 13 x 16 h	135	4.77	1.5 kg	3 lb 5 oz
TUNA	95 x 40 x 41 h	37 1/2 x 15 3/4 x 16 1/8 h	120	4.23	3.5 kg	7 lb 11 oz
GORGONA	ø 38 x 96 h	ø 15 x 37 3/8 h	107	3.78	750 g	1 lb 10 oz
ROATAN	ø 39.5 - 72 h	15 ø - 28 h	90	3.18	1.2 kg	2 lb 10 oz
UTILA	ø 38.5 - 70 h	15 ø - 27 h	85	3.00	1.1 kg	2 lb 7 oz
CRETE	ø 37 x 60 h	ø 14 5/8 x 23 5/8 h	64.5	2.28	580 g	1 lb 4 oz
PIPER	35.5 x 23 x 56 h	14 x 9 x 22 h	49	1.73	2.9 kg	6 lb 6 oz
DRY GARA BACK	39.5 x 23.5 x 66 h	15 x 9 x 26 h	60	2.12	1.12 kg	2 lb 7.5 oz
PIOVRA	30 x 30 x 102 h	11 3/4 x 11 3/4 x 40 1/8 h	70	2.47	1.5 kg	3 lb 5 oz
PIOVRA XL	30 x 30 x 130 h	11 3/4 x 11 3/4 x 44 h	85	3.00	1.6 kg	3 lb 8 oz
OCTOPUS	ø 23 x 54 h	ø 9 x 21 1/2 h	30	1.06	660 g	1 lb 7 oz
DRY BAG 20 L	ø 23 x 43 h	ø 9 x 17 h	20	0.71	480 g	16.9 oz
DRY BAG 15 L	ø 23 x 34 h	ø 9 x 13 1/2 h	15	0.53	350 g	12.3 oz
DRY BAG 10 L	ø 19 x 36 h	ø 7 1/2 x 14 1/8 h	10	0.35	320 g	11.3 oz
DRY BAG 5 L	ø 19 x 28 h	ø 7 1/2 x 11 h	5	0.18	255 g	9 oz

Cressi's Size Chart is to be used as a reference only

MEN'S LONG WETSUITS DIMENSION CHART



SIZE	WEIGHT		A - HEIGHT		B - CHEST		C - WAIST		D - HIP		
	US/EU	KG	LB	CM	IN	CM	IN	CM	IN	CM	IN
X5: 36/46		50-58	110-128	156-165	61-65	70-75	28-30	59-65	23-26	72-77	28-30
S: 38/48		60-68	132-150	164-173	65-68	78-83	31-33	65-71	25-28	78-83	31-33
M: 40/50		70-78	154-172	169-178	67-70	86-91	34-36	71-77	28-30	84-89	33-35
L: 42/52		80-88	176-194	174-183	69-72	94-99	37-39	77-83	30-33	90-95	35/37
XL: 44/54		90-98	198-216	179-188	71-74	102-107	40-42	83-89	33-35	96-101	38-40
2XL: 46/56		100-108	220-238	184-193	72-76	110-115	43-45	89-95	35-37	102-107	40-42
3XL: 48/58		105-115	231-254	191-198	75-78	118-123	46-48	95-101	37-40	108-113	43-45

Cressi's Size Chart is to be used as a reference only

WOMEN'S LONG WETSUITS DIMENSION CHART



SIZE	WEIGHT		A - HEIGHT		B - CHEST		C - WAIST		D - HIP		
	US/EU	KG	LB	CM	IN	CM	IN	CM	IN	CM	IN
X5: 8/42		47-52	104-115	160-165	63-65	77-82	30-32	56-61	22-24	83-87	32-34
S: 10/44		53-58	117-128	165-170	65-67	82-87	32-34	60-65	24-26	87-91	34-36
M: 12/46		59-64	130-141	170-175	67-69	87-92	34-36	64-69	25-27	91-95	36-37
L: 14/48		64-70	141-154	175-180	69-71	92-97	36-38	68-73	27-29	95-99	37-39
XL: 16/50		70-80	154-176	180-185	71-73	97-102	38-40	72-77	28-30	99-103	39-41
2XL: 18/52		80-90	176-198	185-190	73-75	102-107	40-42	76-81	30-32	103-107	40.5-42

Cressi's Size Chart is to be used as a reference only

TROPICAL GLOVES 2MM



SIZE CHART		
SIZE	PALM CIRCUMFERENCE	HAND LENGTH
S	7.5 - 8 in (19 cm - 20.3 cm)	7 - 7.5 in (17.7 cm - 19 cm)
M	8 - 8.5 in (20.3 cm - 21.5 cm)	7.5 - 8 in (19 cm - 20.5 cm)
L	8.5 - 9 in (21.5 cm - 22.8 cm)	8 - 8.5 in (20.5 cm - 21.5 cm)
XL	9 - 9.5 in (22.9 cm - 24.1 cm)	8.5 - 9 in (21.5 cm - 22.8 cm)
2XL	9.5 - 10 in (24.1 cm - 25.4 cm)	9 - 9.5 in (22.9 cm - 24.1 cm)

Cressi's Size Chart is to be used as a reference only

HIGH STRETCH GLOVES



SIZE CHART		
SIZE	PALM CIRCUMFERENCE	HAND LENGTH
S	7.5 - 8 in (19 cm - 20.3 cm)	7 - 7.5 in (17.7 cm - 19 cm)
M	8 - 8.5 in (20.3 cm - 21.5 cm)	7.5 - 8 in (19 cm - 20.5 cm)
L	8.5 - 9 in (21.5 cm - 22.8 cm)	8 - 8.5 in (20.5 cm - 21.5 cm)
XL	9.5 - 10.5 in (24 cm - 26 cm)	8.5 - 9 in (21.5 cm - 22.8 cm)

Cressi's Size Chart is to be used as a reference only

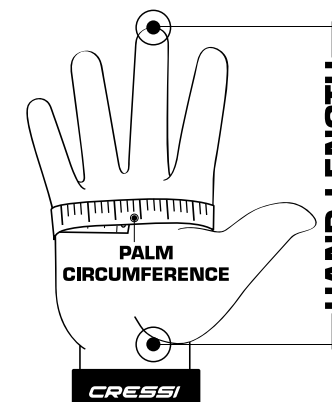

PALM CIRCUMFERENCE:
Measured at area shown (use soft measuring tape)

HAND LENGTH:
Measure from the wrist crease to the tip of the middle finger

HOODS

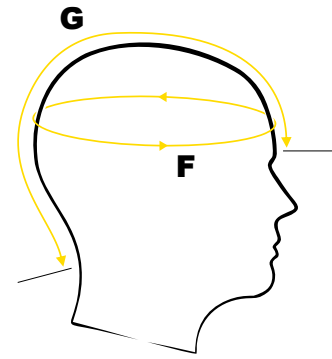

WOMEN'S SIZE CHART			MEN'S SIZE CHART		
SIZE	F HEAD CIRCUMFERENCE	G HEAD LENGTH	SIZE	F HEAD CIRCUMFERENCE	G HEAD LENGTH
XS	19.7 - 21.3 in (50-54 cm)	17.7 - 18.1 in (45-46 cm)	S	20.9 - 22 in (53-56 cm)	17.7 - 18.1 in (45-46 cm)
S/M	21.7 - 22.8 in (55-58 cm)	18.1 - 18.5 in (46-47 cm)	M/L	22 - 23.6 in (56-60 cm)	18.1 - 18.5 in (46-47 cm)
L/XL	23.2 - 24.4 in (59-62 cm)	18.5 - 18.9 in (47-48 cm)	XL/2XL/3XL	23.6 - 25.2 in (60-64 cm)	18.9 - 19.7 in (48-50 cm)

Cressi's Size Chart is to be used as a reference only



TIP TO GET THE SHOE SIZE

Use a ruler to measure the heel to toe length and the chart to determine your shoe size.

BALEARI

RUNS SMALL **FIT SIZE** RUNS LARGE

PRODUCT DIMENSION CHART		SIZE CONVERSION CHART		
SIZE	A HEEL-TOE LENGTH	EU FOOT SIZE	US MEN'S FOOT SIZE	US WOMEN'S FOOT SIZE
5	(23 cm)	36/37	5	6
6	(24 cm)	38/39	6.5	7.5
7	(25 cm)	39/40	7.5	8.5
8	(26 cm)	41/42	9	10
9	(27 cm)	42/43	10	11
10	(28 cm)	44/45	11	12
11	(29 cm)	45/46	12	13
12	(30 cm)	47/48	13.5	14.5

Cressi's Size Chart is to be used as a reference only

MINORCA

RUNS SMALL **FIT SIZE** RUNS LARGE

PRODUCT DIMENSION		SIZE CONVERSION CHART		
HEEL-TOE LENGTH cm	HEEL-TOE LENGTH cm	EU FOOT SIZE	US MEN'S FOOT SIZE	US WOMEN'S FOOT SIZE
22.9	9	36	5	6
23.7	9 1/3	37	6	7
24.6	9 2/3	38.5	7	8
25.4	10	39.5	8	9
26.2	10 1/3	41	9	10
27.1	10 2/3	42	10	11
27.9	11	43.5	11	12
28.8	11 1/3	44.5	12	13
29.6	11 2/3	46	13	14
30.5	12	47	14	14+

Cressi's Size Chart is to be used as a reference only

ANTI-SLIP NEOPRENE SOCKS



PALMA ST

3mm WITH GRIP



PALMA LT

3mm WITH GRIP



TIP TO GET THE SHOE SIZE

Use a ruler to measure the heel to toe length and the chart to determine your shoe size.

SIZE CONVERSION CHART			
SIZE	EU FOOT SIZE	US MEN'S FOOT SIZE	US WOMEN'S FOOT SIZE
S	36 / 38	5 / 6.5	6 / 7.5
M	39 / 40	7 / 8	8 / 9
L	41 / 43	9 / 10.5	10 / 11.5
XL	44 / 46	11 / 12.5	12 / 13.5

* Not available in size XL
Cressi's Size Chart is to be used as a reference only

PRODUCT DIMENSION CHART			SIZE CONVERSION CHART		
SIZE	HEEL-TOE LENGTH CM	HEEL-TOE LENGTH IN	EU FOOT SIZE	US MEN'S FOOT SIZE	US WOMEN'S FOOT SIZE
XS/S	22.9 / 23.7	9 / 9 1/3	36	5 / 6	6 / 7
S/M	23.7 / 25.4	9 1/3 / 10	37	7 / 8	8 / 9
M/L	25.4 / 27.1	10 1/3 / 10 2/3	38.5	9 / 10	10 / 11
L/XL	27.1 / 28.8	11 / 11 1/3	39.5	11 / 12	12 / 13
XL/2XL	28.8 / 30.5	11 2/3 / 12	41	13	14

Cressi's Size Chart is to be used as a reference only

PRODUCT DIMENSION CHART			SIZE CONVERSION CHART		
SIZE	HEEL-TOE LENGTH CM	HEEL-TOE LENGTH IN	EU FOOT SIZE	US MEN'S FOOT SIZE	US WOMEN'S FOOT SIZE
XS/S	22.9 / 23.7	9 / 9 1/3	36	5 / 6	6 / 7
S/M	23.7 / 25.4	9 1/3 / 10	37	7 / 8	8 / 9
M/L	25.4 / 27.1	10 1/3 / 10 2/3	38.5	9 / 10	10 / 11
L/XL	27.1 / 28.8	11 / 11 1/3	39.5	11 / 12	12 / 13
XL/2XL	28.8 / 30.5	11 2/3 / 12	41	13	14

Cressi's Size Chart is to be used as a reference only



Art Direction:
Jenifer Chavez
Editorial & Cover Design:
Alejandra Gómez
Lifestyle images
by **Cressi Ambassadors**

© Cressi Sub S.P.A. All rights reserved.
Reproduction, scanning, transmittal or storage,
by any means of the images in this catalog, whole
or in part, is prohibited without the prior written
permission of Cressi Sub S.P.A.



#WE
MANUFACTURE
QUALITY
SINCE 1946

info@cressiusa.com