



B **BLUE** **CRESSI**



2025
CATALOG
SNORKELING | SWIMMING

NEW

CATALOG BLUE COLLECTION 2025

SNORKELING ADULTS



Full Face Combos	14
Sets	15
Full Face Masks	19
Combos	21
Masks	25
Snorkels	28
Fins	30
Wetsuits	32
Accessories	93
Clean-up Tools	93
Mask Strap Covers	93

SNORKELING JUNIOR LINE



Full Face Masks	41
Sets	36
Combos	42
Masks	47
Snorkels	48
Fins	49
Wetsuits	86
Swimsuits	86

SWIMMING JUNIOR LINE



Swim Goggles Kids	73
Swim Masks Kids	82
Swim Fins	84
Accessories	88

SWIMMING ADULTS



Swim Goggles	53
Accessories	67

BRAND SUPPORT



Displays	93
Spare Parts	93
Dimension Charts	94

INDEX

A		H		R	
AQUA KIT EAR PLUGS + NOSE CLIP	70	H2O DOUBLE WALL 500 ML	69	RIGHT	60
B		H2O DOUBLE WALL 750 ML	69	ROCKS	77
BABALOO REUSABLE DIAPER	89	H2O FROSTED 1L	69	ROCKS PRO DRY SET	37
BALOO	75	H2O FROSTED 600ML	69	RUBBER COATED THERMAL FLASK	69
BARON & TONGA	14	HORIZON & SCILLA	20	S	
BARON	19	I		SCILLA	57
BARON JR	41	IGUANA DRY	48	SCILLA DRY	28
BARON JR & ROCKS SET	36	IKARUS & ORION	23	SEA HORSE	80
BLISS	64	IKARUS & ORION DRY	22	SEASHELL SEAKERS SET	40
BLOWFISH	85	IKARUS	26	SILICONE VALVES KIT FOR FULL FACE MASKS	93
BLUE LINE ADULT COMBO FABRIC BAG	50	ISLAND 2.0	29	SKYLIGHT	53
BLUE LINE ADULT FULL FACE MASK FABRIC BAG	50	K		SNORKEL KEEPER	93
BLUE LINE ADULT MASK FABRIC BAG	50	KIDS SWIMSUIT LONG SLEEVE	86	STARFISH	81
BLUE LINE ADULT SET FABRIC BAG	50	KIDS SWIMSUIT SHORT SLEEVE	87	STRAP & BUCKLES FOR FINS	93
BLUE LINE KIDS COMBO FABRIC BAG	50	KING BALOO	74	STRAP FOR MASK	93
BLUE LINE KIDS FULL FACE MASK FABRIC BAG	50	KING CRAB	76	STRAP FOR SWIM GOGGLES	93
BLUE LINE KIDS MASK FABRIC BAG	50	L		SUMBA XL	90
BLUE LINE KIDS SET FABRIC BAG	50	LIGHT	65	SUPER STRETCH SWIM CAP	67
BLUE LINE KIDS SET NET FABRIC BAG	50	M		SWIFT	67
BONETE PRO	31	MINI BONETE PRO DRY SET	39	SWIFTY KID	88
BONETE PRO DRY SET	17	MINI COBRA	73	SWIM BUOY	67
BUCKLES FOR PEGASO	93	MINI LIGHT	84	T	
BUCKLES FOR SWIM GOGGLES	93	MINI PEG & MINI ISLAND	46	TIBURON	33
C		MINI ISLAND	48	TINETTO & IGUANA DRY	42
CLEAR	57	MOON	83	TINETTO & MINI ISLAND	45
COBRA	55	MOUTH COVER FOR FULL FACE MASKS	93	TINETTO ROCKS DRY SET	38
COMFORT NOSE CLIP	71	MOUTH PIECE FOR SNORKELS	93	TINO & SCILLA	21
COMPLETE SNORKEL FOR FULL FACE MASK	93	MUSA & SCILLA	21	TINO ADVENTURE SET	16
COTTON FRAME	68	MUSA	25	TINO & ISLAND 2.0	23
CRAB	78	MUSA EXPLORER SET	15	TONGA	30
D		N		V	
DOLPHIN 2.0	79	NEOPRENE GOGGLE STRAP COVER	93	VORTEX	62
CRY EAR PLUGS	71	NOSE CLIPS	71	W	
E		NUOTO 3.0	63	WAHOO	32
ELASTIC STRAP FOR FULL FACE MASK	93	O			
F		ORION DRY	29		
FAST DRYING	68	P			
FLASH	58	PEGASO & IGUANA	44		
FOX	61	PEGASO & IGUANA DRY	43		
G		PEGASO	47		
GALILEO	56	PIUMETTA	82		
GOGGLE STRAP COVER	88	PLANET	54		
		PURA	66		



QUALITY PRODUCTS SINCE 1946

Cressi's legacy of innovation began in 1939 with two brothers who shared a passion for the sea and a gift for technical design and working with their hands. Egidio and Nanni Cressi began by crafting masks and spearguns that would allow them to move and hunt more efficiently in the waters near their home. By 1946 their designs and products had become so popular they founded the Cressi company in Genoa, Italy. Today, although Cressi is a worldwide leader in water sports manufacturing, it is still wholly owned by the Cressi family, and the commitment to innovation is still in the company's DNA. It has a long history of groundbreaking product development, and has often been the first to bring product advancements to the market.

This history of innovation is also made possible by a commitment to manufacture products in Italy at the Cressi facility. An investment in the latest manufacturing equipment and more than 16,000 square meters of roofed space, and the ability to have the designing and manufacturing process happen side by side has led to the absolute highest standards for quality. It also allows Cressi engineers to quickly develop, test and incorporate the latest materials and technologies.

Innovations continue, the results today are the same as they were in the beginning, the most advanced and best made products in the world.

CRESSI / Research, Development and Proprietary Exclusive Design

For the past decade, Cressi has dedicated itself to pioneering advancements in snorkeling and swimming technologies. With a relentless commitment to innovation, the company has focused on crafting products that elevate aquatic experiences. By developing proprietary and unique molds, Cressi has ensured precision and quality in every design. These molds serve as the foundation for creating equipment that offers unmatched performance and comfort.

The company's research and development teams have worked tirelessly, merging cutting-edge technology with decades of expertise in underwater sports. From high-performance snorkels to ergonomically designed fins and masks, every product reflects

Cressi's pursuit of excellence. This journey has not only enhanced safety and efficiency for divers but also brought the joy of underwater exploration to a broader audience.

Cressi's dedication to detail and innovation sets it apart, making it a trusted name among professionals and enthusiasts alike. Over the last 10 years, the brand has transformed the snorkeling and swimming landscape, cementing its reputation as a global leader in aquatic gear.

BLUE CRESSI / WARRANTY FIT

Cressi's extensive experience in the world of aquatic sports stands as a testament to the exceptional performance of its products. With decades of expertise, the company has mastered the art of creating high-quality gear that enhances every underwater adventure. This foundation of knowledge ensures that each product meets the highest standards of performance, quality, and comfort.

Every Cressi product is meticulously designed to support the needs of swimmers, snorkelers, and divers, combining advanced technology with ergonomic designs. From masks that offer unparalleled visibility to fins that maximize propulsion, Cressi's equipment is engineered for excellence. This commitment to quality guarantees

reliability in even the most challenging aquatic environments.

By prioritizing user comfort and functionality, Cressi continues to inspire confidence in both professional divers and recreational enthusiasts. The brand's reputation for innovation and durability reflects its unwavering dedication to enhancing underwater experiences. With Cressi, every dive becomes an exploration supported by products you can trust.

B

BLUE
CRESSI

VISION

To inspire a lifelong love for the ocean by creating innovative, safe, and fun snorkeling and swimming gear that connects young families and children to the magic of underwater exploration.

MISSION

To empower families and kids with high-quality, comfortable, and eco-conscious products, designed to make every aquatic adventure safe, accessible, and unforgettable. We aim to cultivate curiosity and respect for the underwater world while fostering joyful experiences for all skill levels.

YOUR PASSPORT TO UNDERWATER EXPLORATION!

This encapsulates the brand's commitment to providing families and children with the tools they need to embark on exciting underwater adventures, nurturing curiosity, and creating memories that last a lifetime.



SNORKELING GEAR



- 100% HIGH QUALITY SILICONE PARTS
- PREMIUM MATERIAL
- TEMPERED LENSES
- TRUSTABLE STRAP SYSTEM

Cressi's snorkeling gear is crafted with high-quality silicone for maximum comfort and durability, ensuring a snug and secure fit for all users. Our masks feature tempered, impact-resistant glass, providing clear vision and enhanced safety during underwater adventures. Designed with families in mind, the trusted buckles on our fins make adjustments effortless, even for young explorers.

Every product combines innovation and ease of use, prioritizing children's safety without compromising performance. Whether it's the softness of the silicone, the strength of the glass, or the reliability of the buckles, Cressi delivers the perfect balance of functionality and comfort.

SWIMMING GEAR



Discover the reliability of swimming gear crafted with precision and care in Italy. Our products are designed to deliver unmatched performance, combining innovation with traditional Italian craftsmanship. Made with premium materials, they ensure durability, comfort, and safety for swimmers of all levels.

From beginner-friendly designs to advanced options for professionals, every piece is engineered to support confident and enjoyable swimming experiences. Trusted worldwide, our Italian-manufactured gear embodies quality and attention to detail.

*"Trusted by parents and loved by kids, Cressi ensures every underwater journey is **safe, fun, and memorable**".*

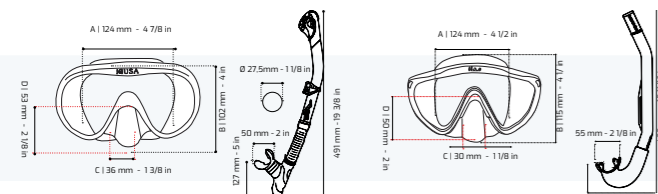

DESIGNED AND MADE IN ITALY



Cressi is proud to announce an **85% REDUCTION** in its environmental impact by transitioning from traditional plastic packaging to more **eco-friendly alternatives**.

Our new packaging is less bulky than clamshell designs, making it convenient for storage and transportation. Additionally, we've reusable protective cases for swim goggles, ensuring **long-lasting protection while reducing waste**.

This significant step aligns with our commitment to protecting the oceans and preserving the environment for future generations.

By adopting sustainable packaging, we ensure that our high-quality products not only enhance your aquatic adventures but also contribute to a healthier planet. With every purchase, you support a cleaner, greener future, reinforcing the connection between exploration and conservation. Together, we're making waves for a better tomorrow.

Previous Packaging:

1. Utilized significantly more plastic due to the clamshell design.
2. Occupied more space in shipping because of the higher volume required for clamshells.

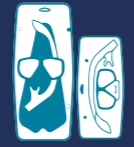

Old Plastic ClamShells



Bulkier and Heavier = Fewer Units per Box, Inefficient Transport Costs, and Higher CO2 Emissions

New Smarter Packaging:

1. Uses plastic bags, reducing plastic usage by 80% and waste compared to traditional clamshells or large cardboard boxes.
2. New design enables more units to fit in the same shipping box, improving shipping efficiency and reducing CO2 emissions from transportation.
3. Features a reusable and repurposable bag, promoting sustainability.

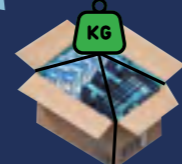

Compact and Lighter = More Units per Box, Optimized Transport Costs, and Reduced CO2 Emissions

80% LESS PLASTIC

There is also a new goggle packaging design created specifically using certified plastic from recycled bottles.

Clean energy for the sea

Our company cares to preserve the planet reducing its environmental impact from his energy sources to the wasting materials; In 2019 we have converted the entire Genoa headquarters and its production facilities at renewable energy sources and we are reducing the consumption of plastics and non-recyclable and polluted materials in packaging.

PET recycling in the circular economy

Recycling plastic brings significant benefits to the environment, because it makes possible to create new objects in high quality recycled. This reduces the demand for raw materials, requires less energy to process and reduces the amount of plastic that ends up in landfills.



Two 1.5 litre recycled water bottles used to make this box



CRESSI B2B PLATFORM: THE BEST SOLUTION



ADULT SNORKELING LINE

JUNIOR SNORKELING LINE



BLUE.CRESSIAMERICA.COM EXCLUSIVE ACCESS FOR AUTHORIZED DEALERS

Access is reserved for authorized Dealers. To get started, submit a request, and once approved in coordination with your Territory Sales Manager, you'll receive an invitation email from b2b@cressiusa.com. This grants full access to the platform's resources.

COMPREHENSIVE RESOURCE LIBRARY

The B2B Dealer Support landing page offers a comprehensive library of essential documents, including product catalogs, agreements, and marketing forms. Regular updates ensure that partners always have access to the latest information

KEY PLATFORM FEATURES:

- Easy Ordering Experience:** Place orders quickly with access to product details, photos, and descriptions.
- 24/7 Product Access:** Real-time inventory and product availability.
- Order Management:** View order history, shipping information, and manage backorders.
- Exclusive Deals:** Receive newsletters with specials and outlet deals.

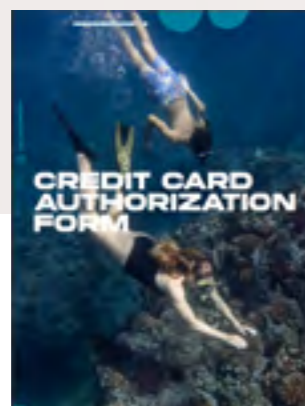

DOWNLOAD

ALL CRESSI DOCUMENTS YOU NEED, READY IN YOUR: BLUE.CRESSIAMERICA.COM DEALER SUPPORT AREA

ASIA BRYNNE

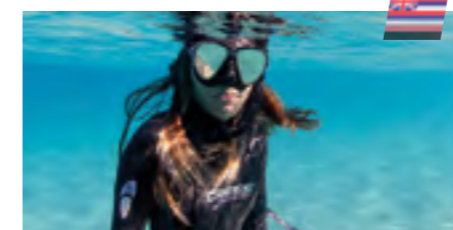

@ asiabrynne

I picked up my first disposable film camera at the age of 8 and never stopped shooting. The ocean is a place away from all of the noise, where you don't have to use words, time doesn't exist, and you can share space with animals. Being underwater is a break from the busyness of life.

BROOKS LAICH

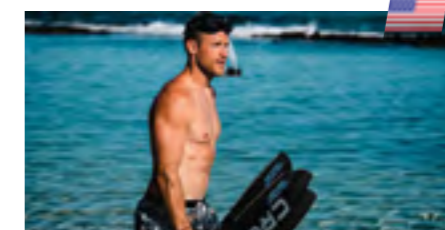

@ brookslaich

He's a Canadian former professional ice hockey forward. He played over 750 National Hockey League games. Brooks is a multi-athlete and a sports lover, so what better way to kick off the day? A little snorkel session when the water is calm and fishes and turtles are active.

CRAIG O'CONNELL

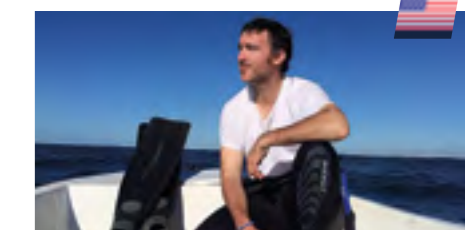

@ thesharkdoctor

I'm from a small town located several hours from the ocean. But I always had a fascination with the ocean, a fascination that really came to fruition during my first shark encounter in the Florida Keys when I was 14. My free diving and scuba career began and has been growing ever since.

THE BUCKET LIST FAMILY



@ thebucketlistfamily

The Geef family, just a typical family working from all over the world as Family Travel Journalists! Their story began in 2015, when they decided to sell everything and leave home for a trip around the world. They started an Instagram and YouTube channel called The Bucket List Family.

VOYAGES OF AGAPE



@ voyagesofagape

Agape is a 1984 Tavaya Vancouver 42', hull #93. "Agape" means unconditional love. She is a true blue water cruiser, and has already seen much of Mexico, the South Pacific, and beyond. For us Agape is home. She is safe and trustworthy vessel that will ferry us to the less seen places of the world.

BECOME THE NEXT CRESSI AMBASSADOR!

Are you passionate about exploring the underwater world and sharing its beauty with others? Dive into an exciting journey with Cressi Snorkeling Blue Line! As an ambassador, you'll represent a brand built on heritage, innovation, and a love for the seas since 1946. Inspire others to embrace the ocean, promote sustainability, and showcase the magic of snorkeling with gear crafted for adventure. Tell your story, and become a part of the Cressi family.

Interested?
Email us at marketing@cressiusa.com

SNORKELING

YOUR PASSPORT
TO UNDERWATER
EXPLORATION!

BARON & TONGA SET

BARON FULL FACE MASK + TONGA FINNS

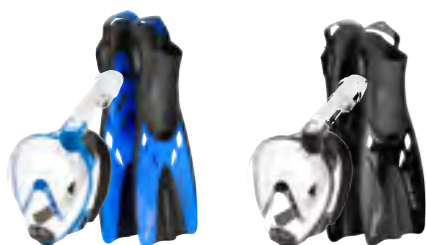

BLUE

BLACK

CODE	COLOR	MASK'S SIZE	FIN'S SIZE
SE010201	CLEAR/BLUE-BLUE	S/M	S/M
SE010204	CLEAR/BLUE-BLUE	M/L	L/XL
SE010501	CLEAR/BLACK-BLACK	S/M	S/M
SE010503	CLEAR/BLACK-BLACK	M/L	L/XL

TONGA FINNS SIZE CHART

SIZE CONVERSION CHART				
FIN SIZE	EU FOOT SIZE	UK FOOT SIZE	US MEN FOOT SIZE	US WOMEN FOOT SIZE
S/M	36/41	3/7	4.5/8.5	5/9.5
L/XL	42/47	7.5/11.5	9/13	10/14

PRODUCT DIMENSION CHART				
A	B	C	D	POCKET HEIGHT
454 mm 17.9 in	182 mm 7.2 in	245 mm 10 in	105 mm 4.1 in	74 mm 2.9 in
468 mm 18.4 in	182 mm 7.2 in	259 mm 10.2 in	105 mm 4.1 in	74 mm 2.9 in

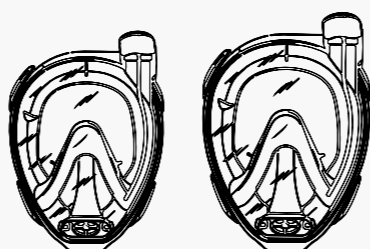
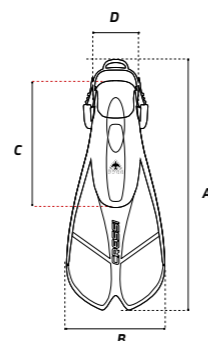

S/M 10 - 12 cm | 4 - 4.5 inch

M/L > 11.5 cm | > 4.5 inch

FIND YOUR IDEAL SIZE

MEASURE WITH THE RULER FROM THE BOTTOM OF THE CHIN TO THE EYELINE



TECHNICAL FEATURES

FULL FACE MASK

- 30% larger viewing area
- The valveless design gives the user effortless and natural breathing, with a wide and individual breathing chamber for nose and mouth.
- The face skirt is made of soft hypoallergenic silicone that gives comfort and a perfect seal.
- The two x-cross straps are easy to adapt for a perfect fit for your head.
- Frame and lens are made of polycarbonate material.

FINNS

- Open heel short blade
- Above blade foot pocket
- Adjustable strap length

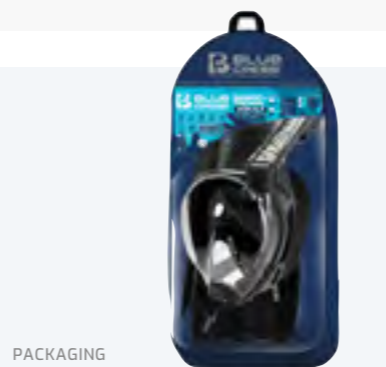

PACKAGING

FINNS COULD COME LABELED WITH EU AND UK SIZES ONLY. CRESSI'S SIZE CHART TO BE USED AS A REFERENCE ONLY.

FITSIZE



TO MAXIMIZE PERFORMANCE AND COMFORT, WEAR FINNS WITH:



MUSA EXPLORER SET

MUSA MASK + TONGA FINNS + SCILLA SNORKEL



ROSE GOLD

BLACK

AQUA GREEN

CODE	COLOR	SIZE
SE234501	ROSE GOLD	S/M
SE234502	ROSE GOLD	L/XL
SE235501	BLACK	S/M
SE235502	BLACK	L/XL
SE236301	AQUA GREEN	S/M
SE236302	AQUA GREEN	L/XL

TONGA FINNS SIZE CHART

SIZE CONVERSION CHART				
FIN SIZE	EU FOOT SIZE	UK FOOT SIZE	US MEN FOOT SIZE	US WOMEN FOOT SIZE
S/M	36/41	3/7	4.5/8.5	5/9.5
L/XL	42/47	7.5/11.5	9/13	10/14

PRODUCT DIMENSION CHART				
A	B	C	D	POCKET HEIGHT
454 mm 17.9 in	182 mm 7.2 in	245 mm 10 in	105 mm 4.1 in	74 mm 2.9 in
468 mm 18.4 in	182 mm 7.2 in	259 mm 10.2 in	105 mm 4.1 in	74 mm 2.9 in

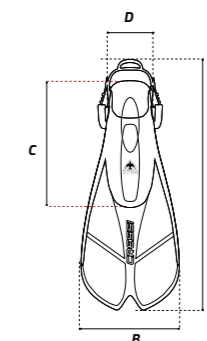

FINNS COULD COME LABELED WITH EU AND UK SIZES ONLY. CRESSI'S SIZE CHART TO BE USED AS A REFERENCE ONLY.

FITSIZE



TO MAXIMIZE PERFORMANCE AND COMFORT, WEAR FINNS WITH:



TECHNICAL FEATURES

MASK

- Frameless technology for maximum comfort
- Single tempered glass lens
- Wide field of view
- High-grade soft silicone
- Double feathered edge skirt
- Quick-adjustable strap buckles
- Easy-access nose pocket for 1-handed ear equalization

SNORKEL

- Dry-top valve seals breathing tube when submerged
- Flexible lower bore reduces jaw fatigue
- Mouthpiece drops away when not in use great for scuba divers
- High-quality silicone mouthpiece is comfortable and durable
- Angled mouthpiece reduces jaw fatigue
- Lower purge valve allows water to be quickly expelled
- Streamlined design reduces drag while swimming
- Adjustable snorkel keeper for securing to any mask

FINNS

- Adult short adjustable snorkeling fins
- Adaptive and comfortable foot pocket made in rubber
- Adjustable strap length
- Short blade, ideal for travel
- Buckle specially designed to ensure robustness and long use

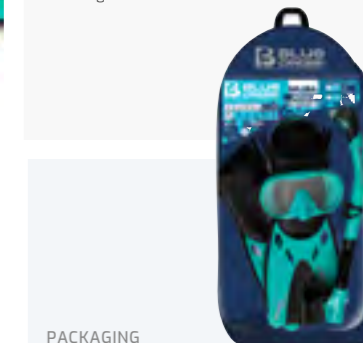

PACKAGING

MUSA MASK SIZE CHART

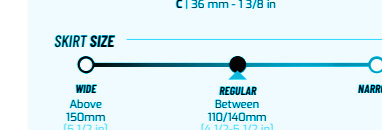
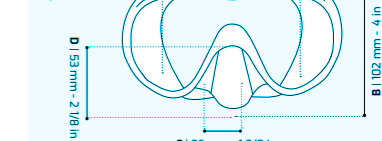

CRESSI'S SIZE CHART IS TO BE USED AS A REFERENCE ONLY

TINO ADVENTURE SET

TINO MASK + TONGA FINS + SCILLA SNORKEL



TECHNICAL FEATURES

MASK

- Frameless technology for maximum comfort
- Single tempered glass lens
- Wide field of view
- High-grade soft silicone
- Double feathered edge skirt
- Quick-adjustable strap buckles
- Easy-access nose pocket for 1-handed ear equalization

SNORKEL

- Dry-top valve seals breathing tube when submerged
- Flexible lower bore reduces jaw fatigue
- Mouthpiece drops away when not in use great for scuba divers
- High-quality silicone mouthpiece is comfortable and durable
- Angled mouthpiece reduces jaw fatigue
- Lower purge valve allows water to be quickly expelled
- Streamlined design reduces drag while swimming
- Adjustable snorkel keeper for securing to any mask

FINS

- Adult short adjustable snorkeling fins
- Adaptive and comfortable foot pocket made in rubber
- Adjustable strap length
- Short blade, ideal for travel
- Buckle specially designed to ensure robustness and long use



CLEAR/BLUE NAVY



BLACK/ICE BLUE



BLACK/GRAPHITE

CODE	COLOR	SIZE
SE240271	CLEAR/BLUE NAVY	S/M
SE240272	CLEAR/BLUE NAVY	L/XL
SE245281	BLACK/ICE CYAN	S/M
SE245282	BLACK/ICE CYAN	L/XL
SE245571	BLACK/GRAPHITE	S/M
SE245572	BLACK/GRAPHITE	L/XL



PACKAGING

TONGA FINS CHART SIZE

SIZE CONVERSION CHART				
FIN SIZE	EU FOOT SIZE	UK FOOT SIZE	US MEN FOOT SIZE	US WOMEN FOOT SIZE
S/M	36/41	3/7	4.5/8.5	5/9.5
L/XL	42/47	7.5/11.5	9/13	10/14

PRODUCT DIMENSION CHART				
A	B	C	D	POCKET HEIGHT
454 mm 17.9 in	182 mm 7.2 in	245 mm 10 in	105 mm 4.1 in	74 mm 2.9 in
468 mm 18.4 in	182 mm 7.2 in	259 mm 10.2 in	105 mm 4.1 in	74 mm 2.9 in

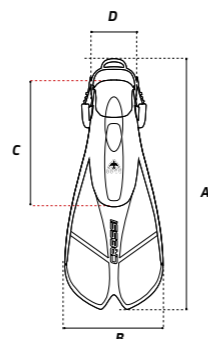

TINO SIZE CHART

SKIRT SIZE

WIDE ——— REGULAR (Between 110/140mm (4 1/2-5 1/2 in)) ——— NARROW

NOSE SIZE

5 — 4 — 3 — 2 — 1

CRESSI'S SIZE CHART IS TO BE USED AS A REFERENCE ONLY

FINS COULD COME LABELED WITH EU AND UK SIZES ONLY. CRESSI'S SIZE CHART TO BE USED AS A REFERENCE ONLY.

FITSIZE



TO MAXIMIZE PERFORMANCE AND COMFORT, WEAR FINN WITH:



BONETE PRO DRY SET

IKARUS MASK + ORION DRY SNORKEL + BONETE PRO FINS



TECHNICAL FEATURES

MASK

- Silicone skirt
- Tempered glass
- Buckle strap
- Length adjustment

SNORKEL

- Top dry valve
- Splash guard top
- Bottom purge valve
- Silicone mouthpiece

FINS

- Open heel short blade
- Above blade foot pocket
- Adjustable strap length



DOUBLE INJECTION PERSONALIZED STRAP



NEWLY REDESIGNED BUCKLE SYSTEM. INCREASED STURDINESS AND LIFESPAN



AQUA



PINK

The Bonete Dry Set is a great all-around snorkel package for the next vacation. The tempered glass mask, the dry snorkel and the short fins, are transportable in a mesh bag. The bag makes it easy to carry, rinse, dry and store the set after use. It is a lightweight and practical set for those who have the desire to travel around the world to explore the underwater world.

CODE	COLOR	SIZE
DM210261	TRANS. AQUA.	S/M
DM210262	TRANS. AQUA.	L/XL
DM210421	TRANS. PINK	S/M
DM210422	TRANS. PINK	L/XL



PACKAGING

BONETE FINS CHART SIZE

SIZE CONVERSION CHART				
FIN SIZE	EU SIZE	UK SIZE	US MM SIZE	US WW SIZE
S/M	36 - 41	3 1/2 - 7 1/2	4 1/2 - 8 1/2	5 1/2 - 9 1/2
L/XL	42 - 47	8 - 12	9 - 13	10 - 14

PRODUCT DIMENSION CHART			
A	B	C	FIN WEIGHT
39.6 cm 15 5/8 in	18.0 cm 7 1/8 in	19.6 cm 7 3/4 in	332 g 12 oz
41.1 cm 16 1/8 in	18.0 cm 7 1/8 in	19.6 cm 7 3/4 in	338 g 12 oz

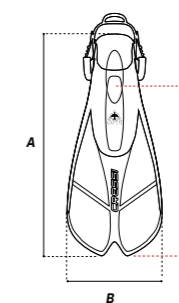

IKARUS SIZE CHART

SKIRT SIZE

WIDE ——— REGULAR (Between 110/140mm (4 1/2-5 1/2 in)) ——— NARROW

NOSE SIZE

5 — 4 — 3 — 2 — 1

CRESSI'S SIZE CHART IS TO BE USED AS A REFERENCE ONLY

FINS COULD COME LABELED WITH EU AND UK SIZES ONLY. CRESSI'S SIZE CHART TO BE USED AS A REFERENCE ONLY.

FITSIZE



TO MAXIMIZE PERFORMANCE AND COMFORT, WEAR FINN WITH:





BARON

WINDOW TO THE SEA

TECHNICAL FEATURES

- 30% larger viewing area
- The valveless design gives the user effortless and natural breathing, with a wide and individual breathing chamber for nose and mouth
- The face skirt is made of soft hypoallergenic silicone that gives comfort and a perfect seal
- The two x-cross straps are easy to adapt for a perfect fit for your head
- Frame and lens are made of polycarbonate material

NEW STRAP PATTERN

AVAILABLE IN FULL-FACE MASKS:
CLEAR/ICE CYAN AND
CLEAR/AQUA GREEN

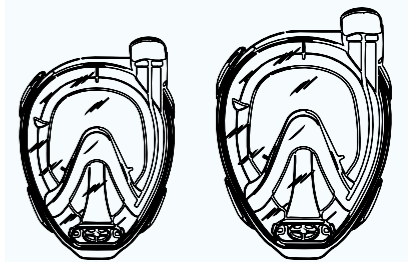

S/M
10-12 cm / 4-4.5 in

M/L
>11.5 cm / >4.5 in

FIND YOUR IDEAL SIZE

MEASURE WITH THE RULER FROM THE BOTTOM OF THE CHIN TO THE EYELINE



CLEAR/BLUE CLEAR/ICE CYAN CLEAR/BLACK CLEAR/AQUA GREEN BLACK/BLACK

CODE	COLOR	SIZE
NEW XDT020020	CLEAR/BLUE	S/M
NEW XDT020023	CLEAR/ICE CYAN	S/M
XDT020050	CLEAR/BLACK	S/M
XDT020091	CLEAR/AQUA GREEN	S/M
XDT025050	BLACK/BLACK	S/M
XDT030020	CLEAR/BLUE	M/L
NEW XDT030023	CLEAR/ICE CYAN	M/L
NEW XDT030050	CLEAR/AQUA GREEN	M/L
XDT030091	CLEAR/BLACK	M/L
XDT035050	BLACK/BLACK	M/L



PACKAGING

The Baron is the version of Duke with a different case pack (cardboard box instead of the reusable bag) and a more simplified aesthetic, but with identical features that differentiate it from other face masks on the market.

The Duke-Baron project has required in-depth studies of the design and circulation of both inlet and exhaust air, in order to solve the usual problems in these masks in competing models and make the Cressi face mask especially safe in any situation. The valveless design guarantees a large supply flow,

unthinkable in other similar models, especially in case of fatigue or stress. The evacuation of the exhalation is channeled in separated ductwork that prevents the accumulation of carbon monoxide in the breathing zone.

The air circulation in Baron is clearly superior to that of any other mask on the market. Tested in the laboratory of the Engineering Department of the Milan Polytechnic, where the results exceeded any expectations.





COMBOS
SNORKELING & BEACH



HORIZON & SCILLA

NEW 2025

HORIZON MASK + SCILLA SNORKEL



CLEAR/BLUE NAVY CLEAR/ICE CYAN BLACK/BLCK

CODE	COLOR
DM570027	CLEAR/NAVY
DM570023	CLEAR/ICE CYAN
DM575050	BLACK/BLACK

PACKAGING



MUSA & SCILLA

FRAMELESS MASK + SNORKEL DRY



AQUA/GREEN



BLACK



ROSE GOLD

TECHNICAL FEATURES

MASK

- Frameless technology for maximum comfort
- Single tempered glass lens
- Wide field of view
- High-grade soft silicone
- Double feathered edge skirt
- Quick-adjustable strap buckles
- Easy-access nose pocket for 1-handed ear equalization

SNORKEL

- Dry-top valve seals breathing tube when submerged
- Flexible lower bore reduces jaw fatigue
- Mouthpiece drops away when not in use great for scuba divers
- High-quality silicone mouthpiece is comfortable and durable
- Angled mouthpiece reduces jaw fatigue
- Lower purge valve allows water to be quickly expelled
- Streamlined design reduces drag while swimming
- Adjustable snorkel keeper for securing to any mask

PACKAGING



BLACK/GRAPHITE



CLEAR/BLUE NAVY



BLACK/ICE BLUE

TECHNICAL FEATURES

MASK

- Frameless technology for maximum comfort
- Single tempered glass lens
- Wide field of view
- High-grade soft silicone
- Double feathered edge skirt
- Quick-adjustable strap buckles
- Easy-access nose pocket for 1-handed ear equalization

SNORKEL

- Dry-top valve seals breathing tube when submerged
- Flexible lower bore reduces jaw fatigue
- Mouthpiece drops away when not in use great for scuba divers
- High-quality silicone mouthpiece is comfortable and durable
- Angled mouthpiece reduces jaw fatigue
- Lower purge valve allows water to be quickly expelled
- Streamlined design reduces drag while swimming
- Adjustable snorkel keeper for securing to any mask

PACKAGING



CODE	COLOR
DM435072	BLACK/GRAPHITE
DM430020	CLEAR/BLUE NAVY
DM435028	BLACK/ICE CYAN
NEW DM430040	CLEAR/TRANSLUCENT PINK

BLUE COMBOS - MUSA AND SCILLA - TINO AND SCILLA

IKARUS & ORION DRY

IKARUS MASK + ORION DRY SNORKEL



TECHNICAL FEATURES

MASKS

- Silicone skirt
- Tempered glass
- Buckle strap
- Length adjustment

SNORKEL

- Top dry valve (Orion dry)
- Splash guard top
- Bottom purge valve
- Silicone mouthpiece

IKARUS SIZE CHART

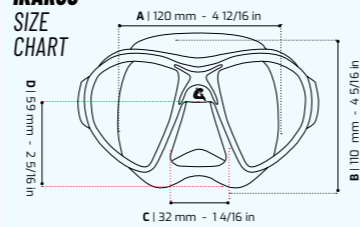

SKIRT SIZE

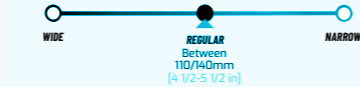

NOSE SIZE



CRESSI'S SIZE CHART IS TO BE USED AS A REFERENCE ONLY

The Ikarus & Orion Dry combo is a lightweight equipment great for travelers that want to discover the underwater world. Both mask and snorkel have parts made with soft and hypoallergenic silicone to ensure comfort and ease of use. The mask has a silicone skirt to ensure comfort and a perfect seal. Thanks to the adjustable buckles, it is possible to adjust the length of the silicone strap. The lenses are

made in tempered glass. The snorkel features a special valve on the top that seals the tube when submerged. The mouthpiece is made in soft silicone for avoiding jaw fatigue. At the bottom, a purge valve makes it easy to purge the water from the snorkel.

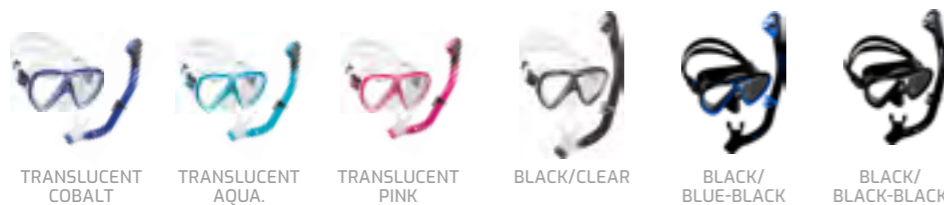

TRANSLUCENT COBALT TRANSLUCENT AQUA TRANSLUCENT PINK BLACK/CLEAR BLACK/BLUE-BLACK BLACK/BLACK-BLACK

CODE	COLOR
DM232121	TRANSLUCENT COBALT
DM232626	TRANSLUCENT AQUA
DM234242	TRANSLUCENT PINK
DM235000	BLACK/CLEAR
DM235520	BLACK/BLUE-BLACK
DM235550	BLACK/BLACK-BLACK



PACKAGING

IKARUS & ORION

IKARUS MASK + ORION SNORKEL

The Ikarus & Orion combo is lightweight equipment great for travelers that want to discover the underwater world. Both mask and snorkel have parts made with soft and hypoallergenic silicone to ensure comfort and ease of use. The mask has a silicone skirt for ensuring comfort and a perfect seal. Thanks to the adjustable buckles, it is possible to adjust the length of the silicone strap. The lenses are made of tempered glass. The snorkel features a special guard on the top that protects the tube from the water. The mouthpiece is made of soft silicone for avoiding jaw fatigue. At the bottom, a purge valve makes it easy to purge the water from the snorkel.



BLACK/YELLOW BLACK/BLUE BLACK/PINK BLACK/BLACK

CODE	COLOR
DM245010	BLACK/YELLOW
DM245020	BLACK/BLUE
DM245040	BLACK/PINK
DM245555	BLACK/BLACK-BLACK



TINO & ISLAND 2.0

TINOS MASK + ISLAND 2.0 SNORKEL

The Tino & Island 2.0 combo suits both novice and experienced snorkelers. The Tino mask has a broad teardrop-shaped tempered glass lens for clear underwater vision, a hypoallergenic silicone skirt with a dual-edge seal for comfort, and an adjustable split strap. The Island 2.0 boasts a streamlined tube and a flexible, easy-to-clear mouthpiece for comfort during extended use, a wide diameter tube for unhindered breathing, and a secure fixed keeper to prevent loss while snorkeling.



CLEAR/BLACK BLACK/BLACK

CODE	COLOR
DM440050	CLEAR/BLACK
DM445050	BLACK/BLACK



PACKAGING



MUSA

FRAMELESS MASK



TECHNICAL FEATURES

- Low volume
- Lightweight
- Single lens
- Tempered glass lens
- Fast-adjusting buckles
- High grade silicone seals bonds directly to the lens for lower weight and reduced drag

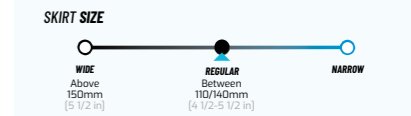
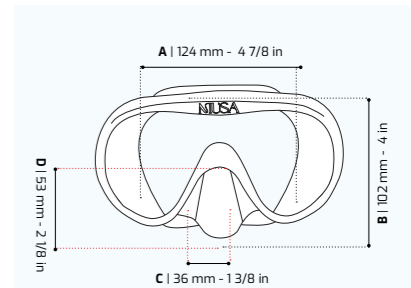

Cressi's Size Chart is to be used as a reference only

Musa is a frameless mask that boasts a low internal volume while offering a wide field of view in all directions. The specific design uses the assembly of the silicone skirt directly over a single tempered glass, guaranteeing superb sturdiness and the perfect watertight seal. The low weight of the mask makes it ideal for packing and travel. The flexible fit and reduced drag are appreciated for freediving and spearfishing,

snorkeling and diving. Making this mask a fantastic choice for any occasion. Additionally, the single tempered glass lens offers a wide field of vision, allowing the wearer to enjoy the underwater world when spearfishing, snorkeling, or scuba diving. The micro-metrically adjustable buckles are comfortable and effective, making adjusting the MUSA quick and easy.



AQUA GREEN



BLACK



ROSE GOLD

CODE	COLOR
DN326363	AQUA GREEN
DN325050	BLACK
DN326161	ROSE GOLD



PACKAGING



IKARUS NEW 2025



BLACK

CLEAR/ICE CYAN

CLEAR/AQUA GREEN

The Ikarus mask is a lightweight, travel-friendly choice for those eager to explore the underwater world. Its soft silicone skirt provides excellent comfort and a secure, watertight seal. The adjustable buckles make it easy to customize the silicone strap

for a perfect fit. Equipped with durable tempered glass lenses, the Ikarus mask ensures clear vision and reliable safety during your underwater adventures. Ideal for snorkeling in any environment.

TECHNICAL FEATURES

- Skirt made of hypoallergenic silicone.
- Lenses made of tempered glass.
- Easy adjustable buckles.

CODE	COLOR
DN335555	BLACK/BLACK
DN330023	CLEAR/ICE CYAN
DN330091	CLEAR/AQUA GREEN

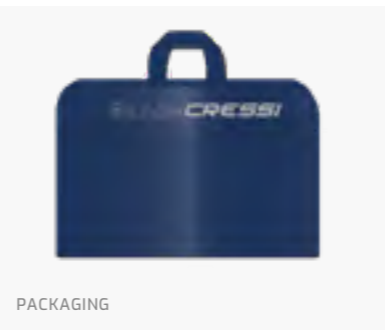
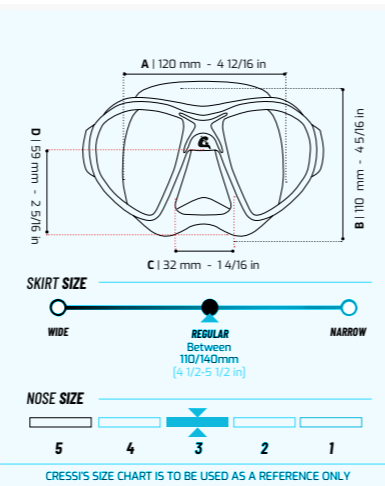

SCILLA DRY

DRY TOP | PURGE VALVE

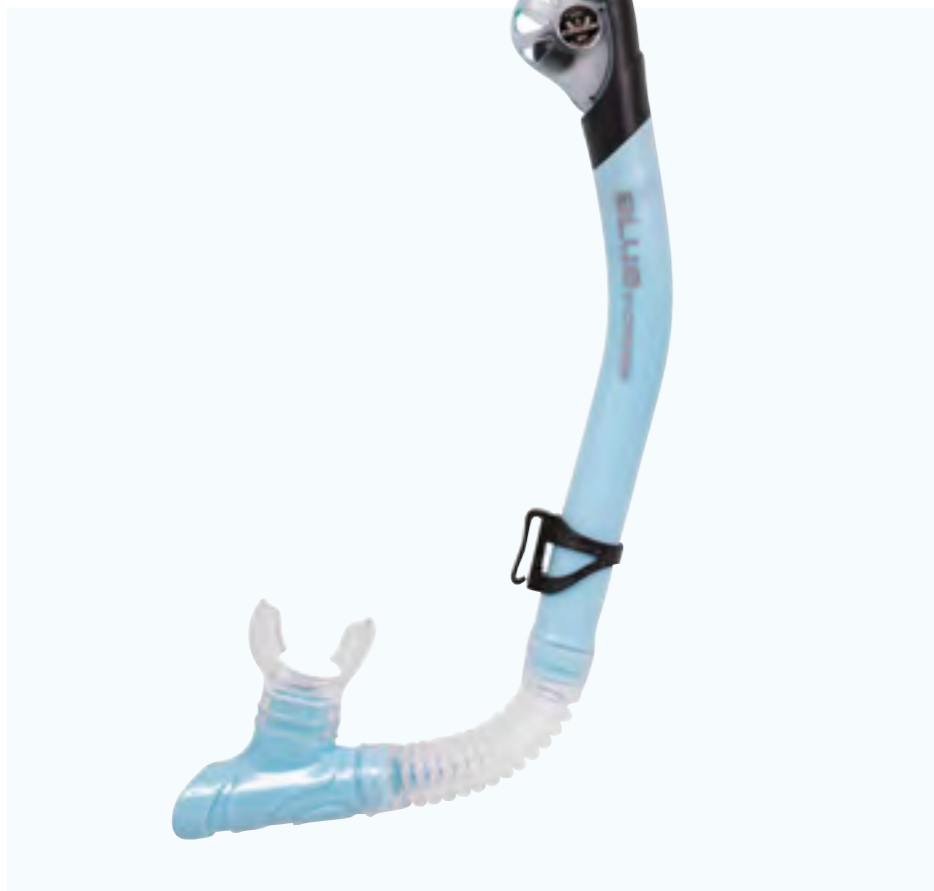

Immerse yourself in underwater wonder with the Cressi Scilla Snorkel. Featuring a Dry Top System, it keeps your breaths crisp. The ergonomic mouthpiece ensures comfort, and the purge valve effortlessly clears water. A splash guard adds convenience, while the corrugated silicone tube provides flexibility. The streamlined design enhances hydrodynamics, and an adjustable snorkel keeper offers a tailored fit. Choose from vibrant colors and elevate your snorkeling with the style-meets-functionality of the Cressi Scilla Snorkel!

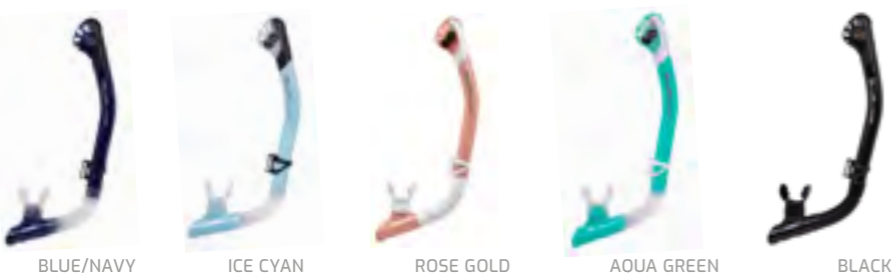

CODE	COLOR	CASE PACK
EG350020	BLUE NAVY	30
EG350028	ICE CYAN	30
EG350061	ROSE GOLD	30
EG350063	AQUA GREEN	30
EG355050	BLACK	30

TECHNICAL FEATURES

- Dry Top System
- Soft silicone mouthpiece
- Splash guard
- Corrugated silicone tube for flexibility
- Streamlined design



PACKAGING

ORION DRY NEW 2025

CODE	COLOR
EG335555	BLACK
EG330027	BLUE NAVY
EG330091	AQUA GREEN



PACKAGING

ISLAND 2.0

The Island snorkel features a minimal tube and a mouthpiece bends that provides easier clearing capability. The multi-positional silicone soft mouthpiece provides extreme comfort during prolonged use. The large diameter snorkel tube provides unobstructed ease of breathing. The fixed keeper prevents loss during snorkeling.



TECHNICAL FEATURES

- Large diameter snorkel tube provides unobstructed airflow
- Ease of breathing
- Fixed snorkeling keeper
- Hypoallergenic soft silicone mouthpiece



CODE	COLOR	CASE PACK
US260050	CLEAR/CLEAR/BLACK	10
US262605	TRANSLUCENT AQUA/CLEAR/BLACK	10
US264205	TRANSLUCENT PINK/CLEAR/BLACK	10
US265510	BLACK/BLACK/YELLOW	10

SPARE PARTS

CODE	PRODUCT
US2631000	MOUTHPIECE - CLEAR FOR ISLAND SNORKEL
US2631050	MOUTHPIECE - BLACK FOR ISLAND SNORKEL

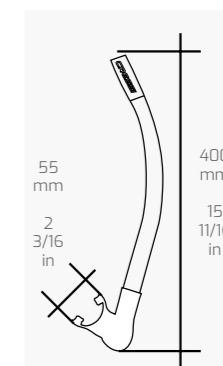

TONGA

SHORT ADJUSTABLE FINN



BLACK/BLUE



BLACK/PINK



BLACK/BLACK

The Cressi Tonga are short open heel fins with adjustable straps to use both outdoors and indoors. They are ideal for travelers thanks to their dimensions and light weight. The buckles have a special design to ensure robustness and long use. The fin strap features a large thumb loop to make easy the donning and doffing. It is also practical to hang them on a hook. The foot pocket is made of a rubber material that makes donning comfortable and easily adapts to different shapes of feet. Being an open foot pocket fin with an adjustable strap, it adapts to different shapes of feet and can also be shared between different people who have a similar size. The composite design of the blade provides comfortable finning and helps to reduce leg cramping. The fins come with a practical net bag ideal for rinsing the fins after use and removing any sand.

TECHNICAL FEATURES

- Adult short adjustable snorkeling fins
- Adaptive and comfortable foot pocket made in rubber
- Adjustable strap length
- Buckle specially designed to ensure robustness and long use
- Short blade, ideal for travel

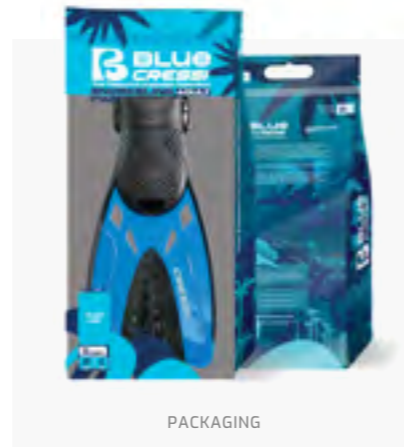

PACKAGING

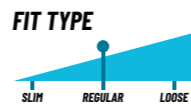
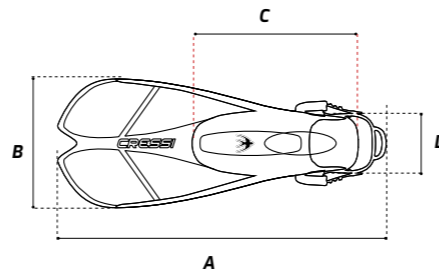

CODE	COLOR	SIZE
CA285201	BLACK/BLUE	S/M
CA285202	BLACK/BLUE	L/XL
CA285401	BLACK/PINK	S/M
CA285402	BLACK/PINK	L/XL
CA285551	BLACK/BLACK	S/M
CA285552	BLACK/BLACK	L/XL

CODE	PRODUCT
US2100020	Strap & Buckles Assembly - Black/Blue for Bonete/Tonga
US2100041	Strap & Buckles Assembly - Black/Pink for Bonete/Tonga
US2100050	Strap & Buckles Assembly - Black/Black for Bonete/Tonga

SIZE CONVERSION CHART				
FIN SIZE	EU FOOT SIZE	UK FOOT SIZE	US MEN FOOT SIZE	US WOMEN FOOT SIZE
S/M	36/41	3/7	4.5/8.5	5/9.5
L/XL	42/47	7.5/11.5	9/13	10/14

PRODUCT DIMENSION CHART				
A	B	C	D	POCKET HEIGHT
454 mm 17.9 in	182 mm 7.2 in	245 mm 10 in	105 mm 4.1 in	74 mm 2.9 in
468 mm 18.4 in	182 mm 7.2 in	259 mm 10.2 in	105 mm 4.1 in	74 mm 2.9 in

BONETE PRO

SHORT ADJUSTABLE FINN



TECHNICAL FEATURES

- Open heel short blade
- Above blade foot pocket
- Adjustable strap length



DOUBLE INJECTION PERSONALIZED STRAP



FIN DETAILS



NEWLY REDESIGNED BUCKLE SYSTEM. INCREASED STURDINESS AND LIFESPAN

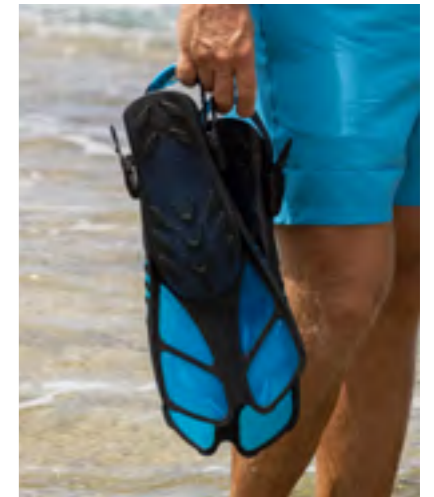

The Bonete fins are short, open-heel fins with adjustable straps. The redesigned buckle system increases the sturdiness and ensures a long lifespan. The fin strap features a large thumb loop for easy donning and doffing. They can also be hung on a hook for drying. The foot pocket is made of a rubber material for comfort and adapts to all feet. This open-foot pocket fin comes with an adjustable strap, which allows it to be shared between different people in a similar foot size-range. The composite design of the blade provides comfortable finning and helps reduce leg cramping. A practical net bag is included with the fins, ideal for rinsing them after use and removing any sand. The fins are ideal for travelers due to their compact dimensions and light weight.



TRANSLUCENT AQUA TRANSLUCENT PINK

CODE	COLOR	SIZE
CA240261	TRANSLUCENT AQUA	S/M
CA240262	TRANSLUCENT AQUA	L/XL
CA240401	TRANSLUCENT PINK	S/M
CA240402	TRANSLUCENT PINK	L/XL

CODE	PRODUCT
US2100020	Strap & Buckles Assembly - Black/Blue for Bonete/Tonga
US2100041	Strap & Buckles Assembly - Black/Pink for Bonete/Tonga
US2100050	Strap & Buckles Assembly - Black/Black for Bonete/Tonga

SIZE CONVERSION CHART				
FIN SIZE	EU SIZE	UK SIZE	US MM SIZE	US WW SIZE
S/M	36 - 41	3 1/2 - 7 1/2	4 1/2 - 8 1/2	5 1/2 - 9 1/2
L/XL	42 - 47	8 - 12	9 - 13	10 - 14

PRODUCT DIMENSION CHART			
A	B	C	FIN WEIGHT
39,6 cm 15 5/8 in	18,0 cm 7 1/8 in	19,6 cm 7 3/4 in	332 g 12 oz
41,1 cm 16 1/8 in	18,0 cm 7 1/8 in	19,6 cm 7 3/4 in	338 g 12 oz

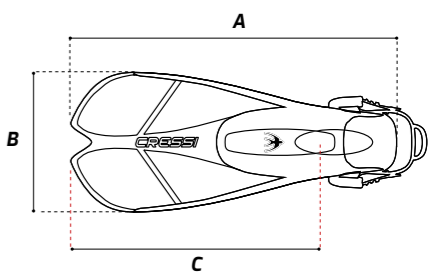

WAHOO

NEW 2025

2mm



TECHNICAL FEATURES

- Adult short adjustable snorkeling fins
- Adaptive and comfortable foot pocket made in rubber
- Adjustable strap length
- Buckle specially designed to ensure robustness and long use
- Short blade, ideal for travel



One-piece wetsuit for adults, made from 1.5/2 mm thick neoprene (front and back) and from Elastane (sides, sleeves, and collar). YKK front zip. Offers excellent protection from the cold and the sun, and maximum freedom of movement thanks to the areas in Elastane that won't irritate the skin during water activities.

MAN

CODE	COLOR	SIZE
XDG022021	BLUE/AZURE	XS
XDG022022	BLUE/AZURE	S
XDG022023	BLUE/AZURE	M
XDG022024	BLUE/AZURE	L
XDG022025	BLUE/AZURE	XL
XDG022026	BLUE/AZURE	2XL
XDG022027	BLUE/AZURE	3XL

LADY

CODE	COLOR	SIZE
XDG022121	BLUE/AZURE	XS
XDG022122	BLUE/AZURE	S
XDG022123	BLUE/AZURE	M
XDG022124	BLUE/AZURE	L
XDG022125	BLUE/AZURE	XL
XDG022126	BLUE/AZURE	2XL



TIBURON

NEW 2025

3mm



TECHNICAL FEATURES

- Premium 1.5/2mm neoprene
- For snorkeling, swimming, and water sports
- Protection from the sun, wind, and cold
- Front zip



QUICK DONNING



DOUBLE MATERIAL NEOPRENE + ELASTAN

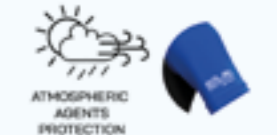

ATMOSPHERIC AGENTS PROTECTION



One-piece wetsuit for adults, made from 1.5/2 mm thick neoprene (front and back) and from Elastane (sides, sleeves, and collar). YKK front zip. Offers excellent protection from the cold and the sun, and maximum freedom of movement thanks to the areas in Elastane that won't irritate the skin during water activities.

MAN

CODE	COLOR	SIZE
XDG014522	BLACK/BLUE	S
XDG014523	BLACK/BLUE	M
XDG014524	BLACK/BLUE	L
XDG014525	BLACK/BLUE	XL
XDG014526	BLACK/BLUE	2XL
XDG014527	BLACK/BLUE	3XL

LADY

CODE	COLOR	SIZE
XDG015521	BLACK/AQUAMARINE	XS
XDG015522	BLACK/AQUAMARINE	S
XDG015523	BLACK/AQUAMARINE	M
XDG015524	BLACK/AQUAMARINE	L
XDG015525	BLACK/AQUAMARINE	XL
XDG015526	BLACK/AQUAMARINE	2XL

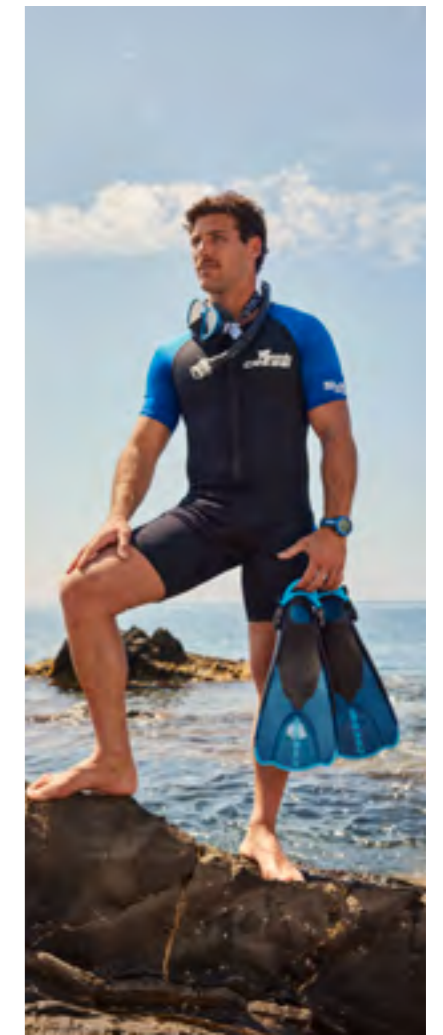



MASK SIZE CHART

MASK FIT SIZE



++ Measure your face from ear to ear with a ruler to find your proper fit.

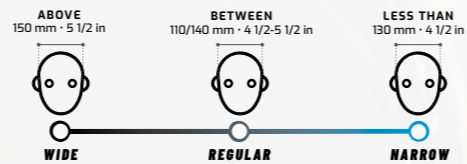

LARGER
|
SMALLER

MASK	SKIRT (OUTER)				SIZING GUIDE	LINE
	WIDTH (mm)	HEIGHT (mm)	WIDTH (in)	HEIGHT (in)		
TINO	124	115	4 7/8	4 1/2	WIDE - REGULAR	ADULT
MUSA	124	102	4 7/8	4	WIDE - REGULAR	ADULT
IKARUS	120	110	4 12/16	4 5/16	REGULAR	ADULT
HORIZON	102	102	4.00	4	REGULAR - NARROW	ADULT
MINI PEGASO	102	73.70	4.00	2 7/8	WIDE	KIDS
PEGASO	113	113	4 7/16	4 7/16	WIDE - REGULAR	KIDS
TINETTO	112	86	4 3/8	3 3/8	REGULAR	KIDS

BARON JR & ROCKS SET

BARON JR FULL FACE MASK + ROCKS FINS



CODE	COLOR	SIZE
SE0202032	BLUE/WHITE	L/XL
SE0204132	LILAC/WHITE	L/XL

TECHNICAL FEATURES

- 30% larger viewing area, snorkelers can see all the underwater world has to offer without feeling claustrophobic
- Dry snorkel keeps water out, while a specialized deflector maximizes air circulation and eliminates fogging
- The valve's design gives the user effortless and natural breathing, with a wide breathing area around the nose and mouth
- Water draining valves safely remove any water that may enter the mask
- This mask is designed for surface use only and should not be used at depth
- Face skirt is made of soft hypoallergenic silicone for comfort and an excellent seal
- Two x-cross straps are easy to adjust for a perfect adaption to your head
- Frame and lens are made of polycarbonate material
- Made in two sizes to ensure proper fitting
- Adjustable straps
- Straps have large thumb loop for easy donning and doffing
- Dual vented blades for power and energy saving
- Compact size, good for travel

0	1	2	3	4	5	6	7	8	9	10	11	12	13	14	15	16
YEARS OLD																

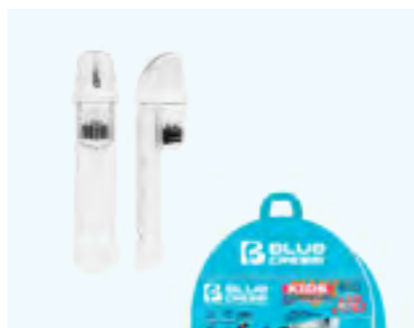

PACKAGING

SIZE CONVERSION CHART					
FIN SIZE	EU FOOT SIZE	UK KID'S FOOT SIZE	US KID'S FOOT SIZE	KIDS AGE	FOOT LENGTH
L/XL	32/38	13k/5y	6.5/8	6/10 YEARS	20-24 cm 8 1/8 - 9 1/2 in

PRODUCT DIMENSION CHART					
A	B	C	D	FIN HEIGHT FIT	
379 mm 14.9 in	177 mm 7 in	205 mm 8.1 in	87 mm 3.5 in	59 mm 2.4 in	

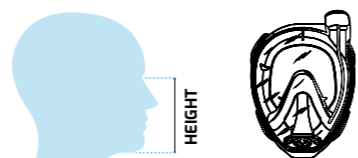
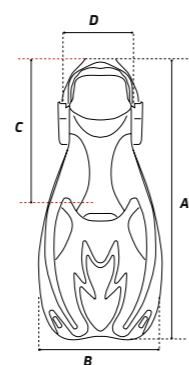

BARON JR DIMENSION CHART			
SIZE	HEIGHT (mm)	HEIGHT (in)	KIDS AGE
XS/S	< 100	< 4	6-12 YEARS

CRESSI'S SIZE CHART TO BE USED AS A REFERENCE ONLY

USA REV. 06/2023

FINS COULD COME LABELED WITH EU AND UK SIZES ONLY
CRESSI'S SIZE CHART TO BE USED AS A REFERENCE ONLY

FITSIZE



TO MAXIMIZE PERFORMANCE AND COMFORT, WEAR FINN WITH:



USA REV. 06/2023

ROCKS PRO DRY SET

PEGASO MASK + IGUANA DRY SNORKEL + ROCKS FINS



TECHNICAL FEATURES

- Short adjustable open-heel fins
- Dry snorkel with quick-release keeper and purge valve
- Soft silicone dual-lens mask

0	1	2	3	4	5	6	7	8	9	10	11	12	13	14	15	16
YEARS OLD																



BLUE/WHITE

LILAC/WHITE



PACKAGING

The Rocks Pro Dry Set is Cressi's answer to the price conscious parents who need reliable snorkel equipment for their kids for vacation use. We offer with this line the solution for adventurous kids who need decent quality for all day use in the pool or in the ocean. The Rocks Mask lenses are made from tempered glass and the dual window design provides excellent and a wide field of vision. Mask has an easy-to-reach nose pocket for ear equalization. The skirt is made in quality silicone, a material softer than traditional PVC that is very comfortable and ensures a perfect seal. The Rocks Snorkel features the splash guard designed to prevent splashed surface water from entering inside the snorkel barrel. The soft and replaceable

silicone mouthpiece, in combination with the flex tube section, allows for hours of comfortable snorkeling fun. The one-way purge valve below the mouthpiece allows and water in the tube to drain-rapidly. The snorkel comes complete with an easy-to-use snorkel keeper for attachment to the mask strap. Soft and comfortable vented open heel foot provides excellent power and energy saving efficiency. A practical net bag is included in the set. adventures that will last all day.

CODE	COLOR	SIZE
SE262031	BLUE/WHITE	S/M
SE262032	BLUE/WHITE	L/XL
SE264131	LILAC/WHITE	S/M
SE264132	LILAC/WHITE	L/XL

ROCKS FINS CHART SIZE

SIZE CONVERSION CHART					
FIN SIZE	EU FOOT SIZE	UK KID'S FOOT SIZE	US KID'S FOOT SIZE	KIDS AGE	FOOT LENGTH
S/M	26/32	8.5/12.5 k	4/6.5	3/5 YEARS	16-20 cm 6 1/3 - 8 1/8 in
L/XL	32/38	13k/5y	6.5/8	6/10 YEARS	20-24 cm 8 1/8 - 9 1/2 in

PRODUCT DIMENSION CHART					
A	B	C	D	FIN HEIGHT FIT	
348 mm 13.7 in	170 mm 6.7 in	188 mm 7.4 in	79 mm 3.2 in	58 mm 2.3 in	
379 mm 14.9 in	177 mm 7 in	205 mm 8.1 in	87 mm 3.5 in	59 mm 2.4 in	

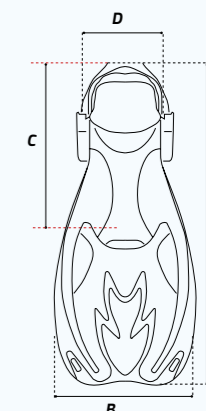

FINS COULD COME LABELED WITH EU AND UK SIZES ONLY
CRESSI'S SIZE CHART TO BE USED AS A REFERENCE ONLY

FITSIZE



TO MAXIMIZE PERFORMANCE AND COMFORT, WEAR FINN WITH:



USA REV. 06/2023

TINETTO ROCKS DRY SET

TINETTO MASK + DRY SNORKEL + ROCKS FINN



TECHNICAL FEATURES

- MASK**
- Tempered glass
 - Single lens
 - Adjustable buckles
 - Silicone skirt
 - Split head strap
- SNORKEL**
- Dry top valve system
 - Quick release snorkel keeper
 - Bottom purge valve
 - Silicone mouthpiece
- FINS**
- Dual composite vented blades
 - Foot pockets made of rubber
 - Buckles with a push-button mechanism for easy strap adjustment
 - Thumb loop in strap

0	1	2	3	4	5	6	7	8	9	10	11	12	13	14	15	16
YEARS OLD																



BLUE NAVY/ICE CYAN AQUAGREEN/WHITE

The TinettoRocksDrySetis perfect for young snorkelers eager to explore marine life. It features a single-lens mask with tempered glass for clarity, adjustable side buckles, a silicone skirt, and a split head strap for a secure, comfortable fit. The Iguana Dry snorkel has a dry top valve to prevent water entry, a snorkel keeper for mask

attachment, a silicone mouthpiece to prevent jaw fatigue, and a bottom purge valve for easy water clearing. The Rocks fins reduce fatigue with vented blades and have rubber foot pockets for comfort. The easy-to-adjust curvatures, thumb loop, and rubber foot pockets ensure a user-friendly experience.

CODE	COLOR	SIZE
SE252721	BLUE NAVY/ICE CYAN	S/M
SE252722	BLUE NAVY/ICE CYAN	L/XL
SE256331	AQUA GREEN/WHITE	S/M
SE256332	AQUA GREEN/WHITE	L/XL



PACKAGING

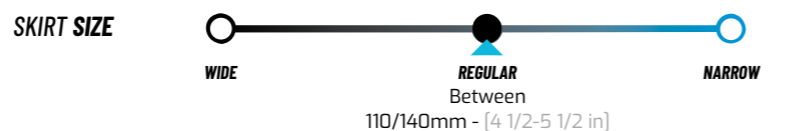
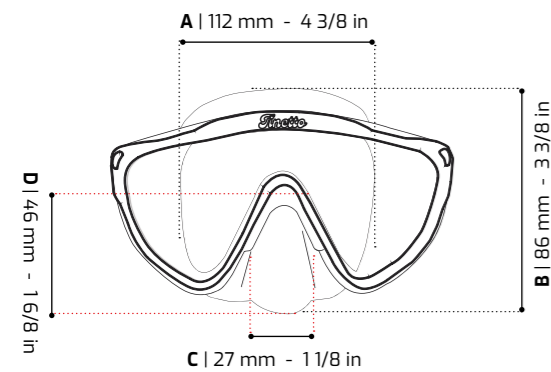

MINI BONETE PRO DRY SET

PEGASO MASK + IGUANA DRY SNORKEL + MINI BONETE FIN



TECHNICAL FEATURES

- A lightweight and colorful equipment great for young snorkelers that want to have fun discovering the underwater world.
- Both mask and snorkel have parts made with soft and hypoallergenic silicone to ensure comfort and easy to use.
- The mask's buckles are easy-to-use for length strap adjustment.
- The Mini Bonete are short open heel fins with adjustable straps.

0	1	2	3	4	5	6	7	8	9	10	11	12	13	14	15	16
YEARS OLD																



BLUE/WHITE LILAC/WHITE

The Mini Bonete set is lightweight and colorful equipment great for young snorkelers that want to have fun discovering the underwater world. Both mask and snorkel have parts made with soft and hypoallergenic silicone to ensure comfort and ease to use. The tempered glass of the mask ensures a clear view and safe use. The mask's buckles are easy-to-use for length

strap adjustment. The snorkel has a practical keeper to clip it to the mask's strap. The Mini Bonete is a short open-heel fin with adjustable straps. The foot pocket is easy to fit and comfortable. The design is made to ensure lightweight and relaxed finning.

CODE	COLOR	SIZE
SE222031	BLUE/WHITE	S/M
SE222032	BLUE/WHITE	L/XL
SE224131	LILAC/WHITE	S/M
SE224132	LILAC/WHITE	L/XL



PACKAGING

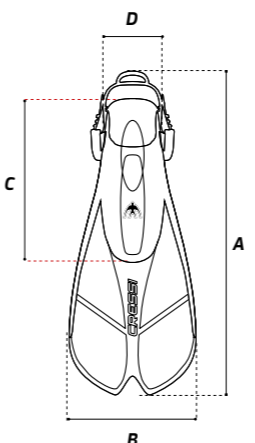

SIZE CONVERSION CHART					
FIN SIZE	EU FOOT SIZE	UK KID'S FOOT SIZE	US KID'S FOOT SIZE	KIDS AGE	FOOT LENGTH
S/M	26/32	8.5/12.5 k	4/6.5	2/5 YEARS	16-20 cm 6 1/3 - 8 1/8 in
L/XL	32/38	13k/5y	6.5/8	5/7 YEARS	20-24 cm 8 1/8 - 9 1/2 in

PRODUCT DIMENSION CHART				
A	B	C	D	FIN HEIGHT FIT
32,2 cm 12.7 in	15,5 cm 6.1 in	7,6 cm 3.0 in	8,5 cm 3.3 in	5,0 mm 2.0 in
35,0 cm 13.8 in	16,1 cm 6.3 in	8,2 cm 3.2 in	8,8 cm 3.5 in	5,2 mm 2.0 in

FINS COULD COME LABELED WITH EU AND UK SIZES ONLY CRESSI'S SIZE CHART TO BE USED AS A REFERENCE ONLY
USA REV. 06/2023

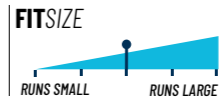

TO MAXIMIZE PERFORMANCE AND COMFORT, WEAR FINN WITH:

<input checked="" type="checkbox"/> BARE FOOT	<input type="checkbox"/> NEOPRENE SOCKS	<input type="checkbox"/> NEOPRENE BOOTS 2 mm - 3 mm - 4 mm	<input type="checkbox"/> HARD SOLE BOOTS 2 mm - 3 mm - 4 mm
---	---	---	--

SEASHELL SEEKERS SET

NEW 2025



IDEAL FOR YOUNG KIDS
2 TO 5 YEARS OLD

0	1	2	3	4	5	6	7	8	9	10	11	12	13	14	15
YEARS OLD															

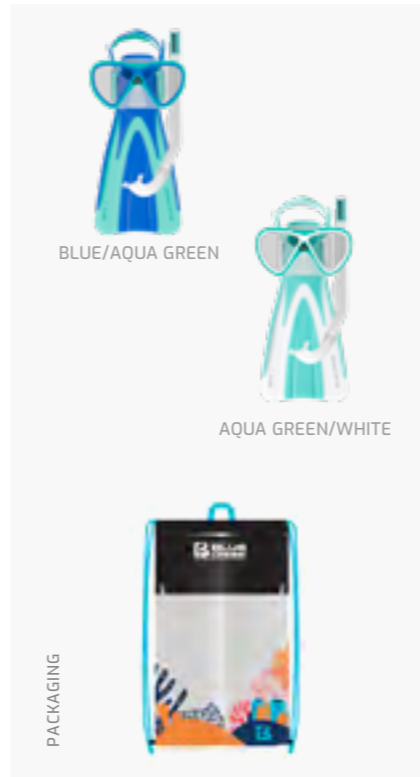

CODE	COLOR	SIZE
SE279122	BLUE/AQUA GREEN	S/M
SE279132	AQUA GREEN/WHITE	S/M



BARON JUNIOR

WINDOW TO THE SEA



TECHNICAL FEATURES

- 30% larger viewing area, snorkelers can see all the underwater world has to offer without feeling claustrophobic
- Dry snorkel keeps water out, while a specialized deflector maximizes air circulation and eliminates fogging
- The valve's design gives the user effortless and natural breathing, with a wide breathing area around the nose and mouth
- Water draining valves safely remove any water that may enter the mask
- This mask is designed for surface use only and should not be used at depth
- Face skirt is made of soft hypoallergenic silicone for comfort and an excellent seal
- Two x-cross straps are easy to adjust for a perfect adaptation to your head
- Frame and lens are made of polycarbonate material

0	1	2	3	4	5	6	7	8	9	10	11	12	13	14	15
YEARS OLD															



CODE	COLOR	SIZE
XDT0360026	CLEAR/AQUA	XS
XDT0360040	CLEAR/PINK	XS

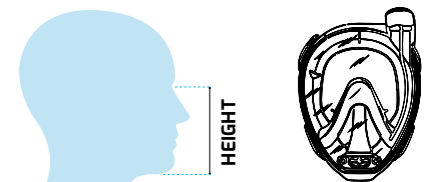

BARON JR DIMENSION CHART

SIZE	HEIGHT (mm)	HEIGHT (in)	KIDS AGE
XS/S	< 100	< 4	6-12 YEARS

CRESSI'S SIZE CHART TO BE USED AS A REFERENCE ONLY

BLUE - KIDS - TINETTO AND IGUANA DRY

TINETTO & IGUANA DRY

TINETTO MASK + IGUANA DRY SNORKEL



BLUE NAVY/ICE CYAN

AQUA GREEN/WHITE

The Tinetto & Iguana Dry combo is a lightweight and reliable choice for young snorkelers. The Tinetto mask, with a single tempered glass lens, ensures clarity. Adjustable side buckles ease strap length changes. The Iguana Dry snorkel has a top valves system to seal the tube when submerged, preventing water entry. It includes a snorkel keeper for mask attachment, a silicone mouthpiece to reduce jaw fatigue, and a bottom purge valve for easy water clearing.

CODE	COLOR
DM452728	BLUE NAVY/ICE CYAN
DM456330	AQUA GREEN/WHITE

TECHNICAL FEATURES

MASK:

- Tempered glass
- Single lens
- Adjustable buckles
- Silicone skirt
- Split head strap

SNORKEL

- Dry top valve system
- Quick release snorkel keeper
- Bottom purge valve
- Silicone mouthpiece

0	1	2	3	4	5	6	7	8	9	10	11	12	13	14	15	16
YEARS OLD																



PACKAGING

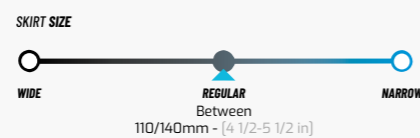

PEGASO & IGUANA DRY

PEGASO MASK + IGUANA DRY SNORKEL



0	1	2	3	4	5	6	7	8	9	10	11	12	13	14	15	16
YEARS OLD																

PEGASO MASK SIZE CHART

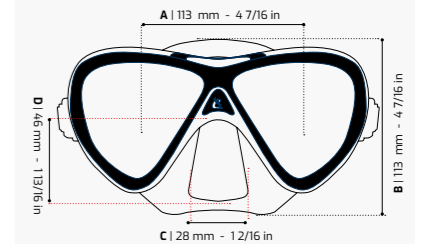

DIMENSION CHART

A WIDTH	B HEIGHT	C NOSE LENGTH	D NOSE HEIGHT	E NOSE WIDTH
113 mm 4 7/16 in	113 mm 4 7/16 in	28 mm 1 2/16 in	46 mm 1 13/16 in	27 mm 1 1/16 in

CRESSI'S SIZE CHART TO BE USED AS A REFERENCE ONLY

The Pegaso & Iguana combo is a lightweight and inexpensive equipment great for young snorkelers that want to discover the underwater world. Both mask and snorkel have parts made with soft and hypoallergenic silicone to ensure comfort and ease to use. The tempered glass of the mask ensures a clear view and safe use. The mask's buckles are easy-to-use for length strap adjustment. The snorkel has a practical keeper to clip it to the mask's strap.

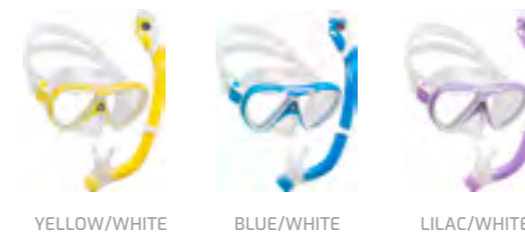

YELLOW/WHITE

BLUE/WHITE

LILAC/WHITE

CODE	COLOR
DM271030	YELLOW/WHITE
DM272030	BLUE/WHITE
DM274130	LILAC/WHITE

SPARE PARTS

CODE	PRODUCT
DZ260030	Strap & Retainers White for Pegaso
DZ271030	Buckles Yellow/White for Pegaso
DZ272030	Buckles Blue/White for Pegaso
DZ274130	Buckles Lilac/White for Pegaso



PACKAGING

DISCOVER THE UNDERWATER WORLD!

PEGASO & IGUANA

FROM 5 TO 15 YEARS | PEGASO MASK + IGUANA SNORKEL



YELLOW/CLEAR



BLUE/WHITE



LILAC/WHITE

The Pegaso & Iguana combo is a lightweight option great for young snorkelers that want to discover the underwater world. Both mask and snorkel have parts made with soft and hypoallergenic silicone to ensure comfort and ease of use. The tempered glass ensures safety and a clear view. The mask's buckles are easy-to-use for length strap adjustment. The snorkel has a practical keeper to clip to the mask's strap.

TECHNICAL FEATURES

MASK:

- Silicone skirt
- Tempered glass
- Adjustable length strap

SNORKEL

- Splash guard top
- Purge valve

0	1	2	3	4	5	6	7	8	9	10	11	12	13	14	15	16
YEARS OLD																

PEGASO MASK SIZE CHART

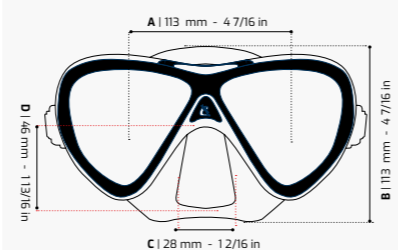

SKIRT SIZE



NOSE SIZE



DIMENSION CHART

A	B	C	D	E
WIDTH	HEIGHT	NOSE LENGTH	NOSE HEIGHT	NOSE WIDTH
113 mm 4 7/16 in	113 mm 4 7/16 in	28 mm 1 2/16 in	46 mm 1 13/16 in	27 mm 1 1/16 in

CRESSI'S SIZE CHART TO BE USED AS A REFERENCE ONLY



PACKAGING

CODE	COLOR
DM261000	YELLOW/CLEAR
DM262030	BLUE/WHITE
DM264130	LILAC/WHITE

CODE	PRODUCT
DZ260030	Strap & Retainers White for Pegaso
DZ271030	Buckles Yellow/White for Pegaso
DZ272030	Buckles Blue/White for Pegaso
DZ274130	Buckles Lilac/White for Pegaso

TINETTO & MINI ISLAND

TINETTO MASK + MINI ISLAND SNORKEL



TECHNICAL FEATURES

MASK:

- Tempered glass
- Single lens
- Adjustable buckles
- Silicone skirt
- Split head strap

SNORKEL

- Minimizing bends in the tube and mouthpiece makes clearing easier
- A secure keeper is provided to prevent losing the snorkel
- Mouthpiece is made of silicone
- Unobstructed breathing is made easy with the large diameter snorkel tube

0	1	2	3	4	5	6	7	8	9	10	11	12	13	14	15	16
YEARS OLD																



CLEAR/BLUE

CLEAR/BLACK

The Tinetto & Mini-Island combo offers a straightforward and dependable choice for young snorkelers. The Tinetto features a single-tempered glass lens and user-friendly buckles for strap adjustments. Its silicone skirt ensures a perfect seal and the split head strap ensures comfortable wear. The Mini-Island snorkel is designed to minimize tube and mouthpiece bends for easier clearing.

It includes a secure, built-in snorkel keeper for attachment to the mask, preventing loss while in the water. The silicone mouthpiece reduces jaw fatigue, and the wide-diameter snorkel tube ensures unobstructed breathing.

CODE	COLOR
DM460020	CLEAR/BLUE
DM460050	CLEAR/BLACK
DM465050	BLACK/BLACK

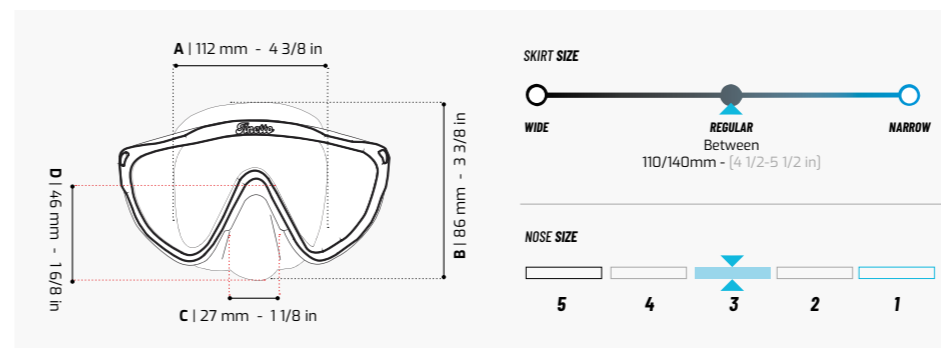

SKIRT SIZE

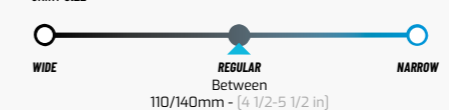

NOSE SIZE



PACKAGING

BLUE - KIDS - MINI PEG AND MINI ISLAND

MINI PEG & MINI ISLAND

NEW 2025



IDEAL AGE
2-5 YEARS

0	1	2	3	4	5	6	7	8	9	10	11	12	13	14	15	16
YEARS OLD																



BLUE

PINK



PACKAGING

CODE	COLOR
DM569120	AQUA GREEN/BLUE
DM569130	AQUA GREEN/ WHITE



PEGASO

NEW 2025



TECHNICAL FEATURES

- Made of hypoallergenic soft silicone.
- Lenses made of tempered glass.
- Easy adjustable buckles.

0	1	2	3	4	5	6	7	8	9	10	11	12	13	14	15	16
YEARS OLD																



AQUA GREEN / WHITE

ICE CYAN / WHITE

The Pegaso mask is a lightweight and affordable option, perfect for young snorkelers excited to explore the underwater world. Made from soft, hypoallergenic silicone, it ensures comfort and a secure fit for extended use. The mask features durable tempered glass lenses

for crystal-clear vision and enhanced safety. Adjustable buckles make strap length adjustments quick and effortless, ensuring a perfect fit every time. Ideal for budding adventurers!



PACKAGING

CODE	COLOR
DN260091	AQUA GREEN/WHITE
DN262330	ICE CYAN/WHITE



IDEAL FOR
BUDDING
ADVENTURERS!

BLUE - KIDS - PEGASO

IGUANA DRY NEW 2025



AQUA GREEN /WHITE

ICE CYAN /WHITE

CODE	COLOR
ES329130	AQUA GREEN/WHITE
ES322330	ICE CYAN/WHITE

0	1	2	3	4	5	6	7	8	9	10	11	12	13	14	15	16
YEARS OLD																



PACKAGING



MINI ISLAND



CODE	COLOR
ZEG265500	CLEAR/YELLOW
ZEG265550	BLACK/YELLOW

TECHNICAL FEATURES

- Minimal tube and mouthpiece bends provides easier clearing capability.
- Fixed keeper that prevents loss during snorkeling
- The multi-positional silicone soft mouthpiece provides extreme comfort during prolonged use
- Large diameter snorkel tube provides unobstructed ease of breathing

0	1	2	3	4	5	6	7	8	9	10	11	12	13	14	15	16
YEARS OLD																



CLEAR/YELLOW

BLACK/YELLOW

ROCKS



TECHNICAL FEATURES

- Adjustable straps
- Straps have large thumb loop for easy donning and doffing.
- Dual vented blades for power and energy saving.
- Compact size, good for travel.

0	1	2	3	4	5	6	7	8	9	10	11	12	13	14	15	16
YEARS OLD																



BLUE/WHITE

LILAC/WHITE



The Rocks are a composite-design, vented open heel fins with adjustable straps designed to follow the kid's growth. The straps have the large thumb-loop for easy donning and doffing. Dual composite vented blades provide excellent power and energy saving efficiency. All in all, these fins are great for family snorkel trips and will allow hours of underwater exploration.

CODE	COLOR	SIZE
CA262031	BLUE/WHITE	S/M
CA262032	BLUE/WHITE	L/XL
CA264131	LILAC/WHITE	S/M
CA264132	LILAC/WHITE	L/XL

SPARE PARTS

CODE	PRODUCT
CZ242030	Strap & Buckles assembly Blue/White for Mini Bonete/Rocks
CZ244130	Strap & Buckles assembly Lilac/White for Bonete/Rocks

ROCKS FINS CHART SIZE

SIZE CONVERSION CHART					
FIN SIZE	EU FOOT SIZE	UK KID'S FOOT SIZE	US KID'S FOOT SIZE	KIDS AGE	FOOT LENGTH
S/M	26/32	8,5/12,5 k	4/6,5	3/5 YEARS	16-20 cm 6 1/3 - 8 1/8 in
L/XL	32/38	13k/5y	6,5/8	6/10 YEARS	20-24 cm 8 1/8 - 9 1/2 in

PRODUCT DIMENSION CHART				
A	B	C	D	FIN HEIGHT FIT
348 mm 13.7 in	170 mm 6.7 in	188 mm 7.4 in	79 mm 3.2 in	58 mm 2.3 in
379 mm 14.9 in	177 mm 7 in	205 mm 8.1 in	87 mm 3.5 in	59 mm 2.4 in

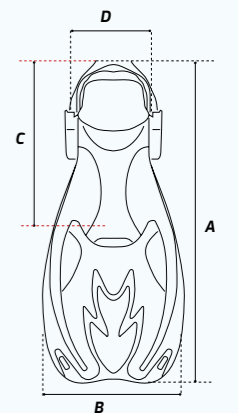

FINS COULD COME LABELED WITH EU AND UK SIZES ONLY. CRESSI'S SIZE CHART TO BE USED AS A REFERENCE ONLY.

USA REV. 06/2023

FIT SIZE



TO MAXIMIZE PERFORMANCE AND COMFORT, WEAR FINN WITH:

<input checked="" type="checkbox"/> BARE FOOT	<input type="checkbox"/> NEOPRENE SOCKS	<input type="checkbox"/> NEOPRENE BOOTS	<input type="checkbox"/> HARD SOLE BOOTS
---	---	---	--

BLUE LINE BAGS NEW 2025



ADULT MASK FABRIC BAG



ADULT FULL FACE MASK FABRIC BAG



ADULT COMBO FABRIC BAG



ADULT SET FABRIC BAG



KID MASK FABRIC BAG



KID FULL FACE MASK FABRIC BAG



KID COMBO FABRIC BAG



KID SET FABRIC BAG



KID SET NET BAG

CODE	PRODUCT
PK142020	Blue Line Adult Mask Fabric Bag (blue-navy)
PK242020	Blue Line Adult Full Face Mask Fabric Bag (blue navy)
PK542020	Blue Line Adult Combo Fabric Bag (blue navy)
PK642020	Blue Line Adult Set Fabric Bag (blue navy)
PK142085	Blue Line Kid Mask Fabric Bag (blue/orange)
PK242085	Blue Line Kid Full Face Mask Fabric Bag (blue/orange)
PK542085	Blue Line Kid Combo Fabric Bag (blue/orange)
PK642085	Blue Line Kid Set Fabric Bag (blue/orange)
PK652085	Blue Line Kid Set Net Bag (blue/orange)

YOUR PASSPORT TO UNDERWATER EXPLORATION!



SWIMMING

ADULTS

MADE IN ITALY

100% SOFT SILICONE

SKYLIGHT

MONO LENS TECHNOLOGY

SWIMMING - GOGGLES - SKYLIGHT

CATALOG - 2024



SKYLIGHT

The Skylight swim mask has an innovative frame design, unique to Cressi. This mask uses mono-lens technology, ensuring maximum comfort without the irritation of a regular goggle. The innovative shape of the frame delivers a maximized peripheral view. The lenses are manufactured with an internal anti-fog treatment, are scratch-resistant, shatterproof, and 100% anti-UV. The lenses are available in the mirrored and tinted versions,

perfect for outdoor use. The silicone strap provides a secure and stable fit on the face for long periods in the water. Our patented easy-adjustable buckle system has made it among the very best, for many years. If you are looking for the ultimate swim mask in the market, the Cressi Skylight is the mask for you.

TECHNICAL FEATURES

- Mono-lens technology ensures maximum comfort without the irritation of a regular goggle
- Maximized peripheral view
- Internal anti-fog treatment
- Scratch-resistant and shatterproof
- 100% anti-UV
- Silicone strap provides a secure and stable fit
- Patented easy-adjustable buckle system
- Perfect for open water and recreational swimming
- Available in mirrored and tinted lenses for outdoor swimming.



CLEAR/BLACK BLUE

CLEAR/WHITE BLUE

CLEAR/WHITE PINK

CLEAR/WHITE BLACK

BLUE METAL

CLEAR/BLACK GREY MIRRORED LENSES

BLACK/BLACK GREY MIRRORED LENSES

BLACK/BLACK SMOKED LENSES

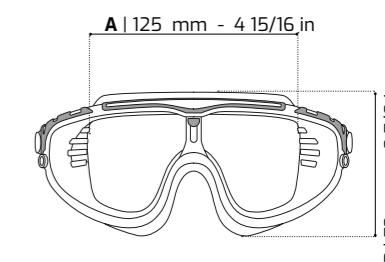

CODE	COLOR	LENSES
DE203320	CLEAR/BLACK/BLUE	CLEAR
DE203322	CLEAR/BLUE/WHITE	CLEAR
DE203340	CLEAR/PINK/WHITE	CLEAR
DE203350	CLEAR/BLACK/WHITE	CLEAR
DE203355	BLUE METAL	CLEAR
DE2033750	CLEAR/BLACK/GRAY	HD MIRRORED
DE203450	BLACK/BLACK/BLACK	TINTED
DE2034750	BLACK/BLACK/GRAY	HD MIRRORED

SPARE PARTS

CODE	PRODUCT
DZ300050	BUCKLES BLACK FOR SWIM GOGGLES
DZ300060	BUCKLES CLEAR FOR SWIM GOGGLES

REUSABLE PROTECTIVE BOX
13,5 x 21 cm
5 5/16 x 8 1/4 in



PLANET



The Planet swim mask has an innovative frame design, unique to Cressi. This silicone mask features wide lenses, ensuring maximum comfort without the irritation of a regular goggle. The innovative shape of the frame delivers a maximized peripheral view. The lenses are manufactured with an internal anti-fog treatment, are scratch-resistant, shatterproof, and 100% anti-UV. The silicone strap provides a secure and stable fit on the face for long periods in the water. Our patented easy-adjustable buckle system has made it among the very best, for many years. If you are looking for the ultimate swim mask in the market, the Cressi Planet is the mask for you. Ideal for recreational and open-water swimming.

TECHNICAL FEATURES

- Wide-lenses and soft silicone offer maximum comfort without the irritation of a regular goggle
- Maximized peripheral view
- Internal anti-fog treatment
- Scratch-resistant and shatterproof
- 100% anti-UV
- Silicone strap provides a secure and stable fit
- Patented easy-adjustable buckle system
- Available in tinted lenses, perfect for outdoor swimming

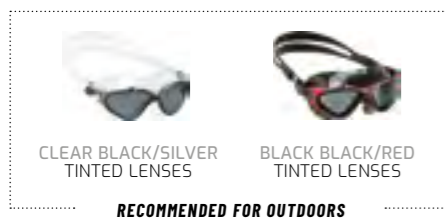

CLEAR BLACK/SILVER TINTED LENSES BLACK BLACK/RED TINTED LENSES

RECOMMENDED FOR OUTDOORS



CLEAR/WHITE/BLUE CLEAR/WHITE/PINK CLEAR/WHITE/LILAC CLEAR/BLACK/SILVER BLUE METAL

CODE	COLOR	LENSES
DE202620	CLEAR - WHITE/BLUE	CLEAR
DE202640	CLEAR - WHITE/PINK	CLEAR
DE202641	CLEAR - WHITE/LILAC	CLEAR
DE202650	CLEAR - BLACK/SILVER	CLEAR
DE2026555	BLUE METAL	CLEAR
DE202651	CLEAR - BLACK/SILVER	TINTED
DE202758	BLACK - BLACK/RED	TINTED

SPARE PARTS

CODE	PRODUCT
DZ300050	BUCKLES BLACK FOR SWIM GOGGLES
DZ300060	BUCKLES CLEAR FOR SWIM GOGGLES
DZ301050	SWIM GOGGLES SILICONE STRAP BLACK
DZ301060	SWIM GOGGLES SILICONE STRAP CLEAR

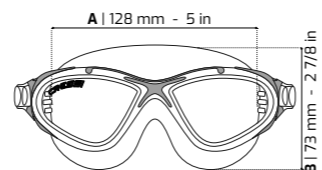

REUSABLE PROTECTIVE BOX
13,5 x 21 cm
5 5/16 x 8 1/4 in

COBRA



The Cobra swim mask has an innovative frame design, unique to Cressi. This mask features wide lenses, ensuring maximum comfort without the irritation of a regular goggle. The innovative shape of the frame delivers a maximized peripheral view.

The lenses are manufactured with an internal anti-fog treatment, are scratch-resistant, shatterproof, and 100% anti-UV.

The silicone strap provides a secure and stable fit on the face for long periods in the water. Our patented easy-adjustable buckle system has made it among the very best, for many years. Available with tinted lenses, perfect for outdoor swimming. If you are looking for the ultimate swim mask in the market, the Cressi Cobra is the mask for you.

TECHNICAL FEATURES

- Ideal for smaller facial profiles
- Wide-lenses and offer maximum comfort without the irritation of a regular goggle
- Maximized peripheral view
- Internal anti-fog treatment
- Scratch-resistant and shatterproof
- 100% anti-UV
- Silicone strap provides a secure and stable fit
- Patented easy-adjustable buckle system
- Available with tinted lenses, perfect for outdoor swimming

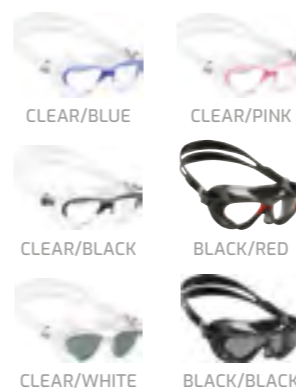

CLEAR/BLUE CLEAR/PINK
CLEAR/BLACK BLACK/RED
CLEAR/WHITE BLACK/BLACK

CODE	COLOR	LENSES
DE201922	CLEAR/BLUE	CLEAR
DE201931	CLEAR/WHITE	TINTED
DE201940	CLEAR/PINK	CLEAR
DE201950	CLEAR/BLACK	CLEAR
DE201991	BLACK/RED	CLEAR
DE201992	BLACK/BLACK	TINTED

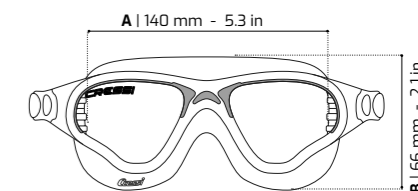

REUSABLE PROTECTIVE BOX
13,5 x 21 cm
5 5/16 x 8 1/4 in

GALILEO

WITH TEMPERED GLASS LENSES

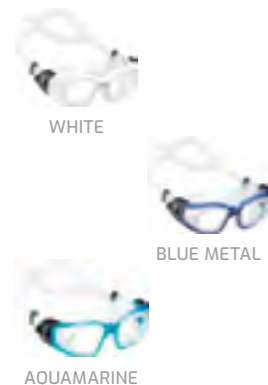

The only swim goggles with tempered glass lenses! The Galileo has marked a new era in the sector of swimming goggles - perfect for any experience level. Their flat lenses are embedded in a rigid frame, as in underwater masks, guaranteeing perfect vision without any distortion while underwater. The soft skirt ensures a watertight seal as well as comfort. The strap is equipped with Cressi's patented quick adjustment system, similar to that used in the prestigious Cressi dive masks. The unbreakable lenses have an external anti-scratch and anti-UV treatment and an internal anti-fog treatment. See for yourself the difference a Cressi goggle can make!

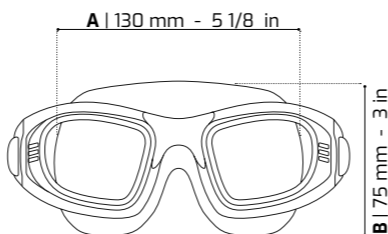

REUSABLE PROTECTIVE BOX
13.5 x 21 cm
5 5/16 x 8 1/4 in

CODE	COLOR	LENSES
DE205030	CLEAR/WHITE	CLEAR
DE205055	CLEAR/BLUE METAL	CLEAR
DE205599	CLEAR/AQUAMARINE	CLEAR

SPARE PARTS	
CODE	PRODUCT
DZ300006	STRAP CLEAR FOR MINIMA/GALILEO



CLEAR

PURE SILICONE SWIM GOGGLES WITH MOLECULAR ANTI-FOG LENS TREATMENT EYES

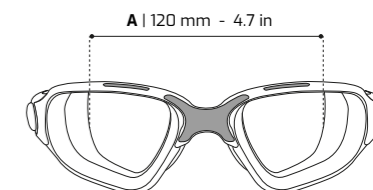

Cressi's Clear Eyes swimming goggles are a true masterpiece of technology and design, conceived to offer superior performance compared to other models in the range. The body of the goggles is made of hypoallergenic silicone, chosen for its exceptional comfort and safety, minimizing the risk of allergic reactions during prolonged use. The Clear Eyes' bi-material frame has been carefully designed to ensure an optimal waterproof seal. This frame combines durable and flexible material to adapt to various face shapes perfectly, resulting in a secure and comfortable fit. The lenses are made with an innovative, patented design by Cressi, featuring a clip fastening system that allows the thickness of the frame to be reduced to a maximum of 1mm, considerably widening the field of vision, almost as if the frame had been eliminated. In addition, the Clear Eyes lenses have been subjected to an advanced anti-fog treatment in the laboratory, which makes them significantly more resistant to fogging than other lenses in the Cressi range. This treatment guarantees crystal-clear visibility in all swimming conditions.

Furthermore, these lenses have been designed to be more resistant, protecting the eyes from UV rays and shocks. The seals have been designed using an avatar with Western facial features, taking into account the curve of the nose bridge and eye sockets. This makes the flexible rubber nose bridge extremely adaptable; its flexibility allows the goggles to conform better to the face, increasing comfort and improving the fit, optimizing it for a wide range of users. Like all Cressi products, Clear Eyes goggles feature the micrometric strap adjustment system, a revolutionary design that Cressi introduced, patented and launched on the market over 20 years ago. Perfect for both serious and recreational swimmers looking for the best in terms of comfort, adaptability, and visual performance, Stream goggles are ideal for those who want to push their limits in the water with maximum safety and comfort.

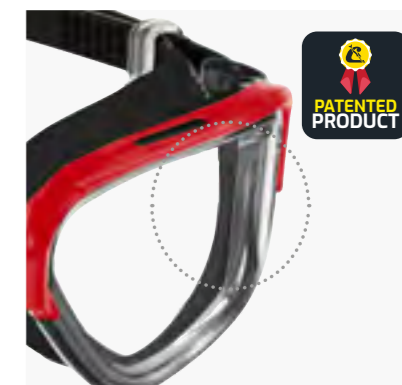

CODE	COLOR	LENSES
ZDE260020	CLEAR/BLUE	CLEAR
ZDE263026	WHITE/AQUAMARINE	CLEAR
ZDE2650508	BLACK/BLACK	SMOKED LENS
ZDE265055	BLACK/GREY	CLEAR
ZDE2650558	BLACK/GREY	SMOKED LENS
ZDE265080	BLACK/RED	CLEAR



REUSABLE PROTECTIVE BOX
13.5x21 cm

FLASH

ADULT SIZE
COMFORTABLE & PERFORMANCE



MAN

The Flash goggles are characterized by an elastic nose bridge, which allows for perfect adaptability to a large number of facial profiles. The lenses are slightly inclined at 18° to follow the natural shape of the human face and increase the field of view. They are also shatterproof and offer UV ray protection. An internal anti-fogging treatment prevents fog during use. The eyes gaskets are made with hypoallergenic, high-quality TPR to ensure comfort and a perfect seal. The double-strap is made of silicone to ensure

a perfect fit without over-tightening. The Cressi-patented buckle system makes adjusting the strap effortless. Easy replacement of strap and buckle system. The Flash are versatile goggles, ideal for recreational swimming and competition, as well as both indoor and outdoor use.

TECHNICAL FEATURES

- Comfortable leak proof eye gasket
- Flexible nose bridge fits various facial profiles
- Split strap made of soft and flexible silicone
- Eyes gaskets made of hypoallergenic, high-quality TPR
- Micrometrically adjustable buckles easy to reach
- Lenses: Inclined 18° anti fog, anti scratch, 100% anti UV

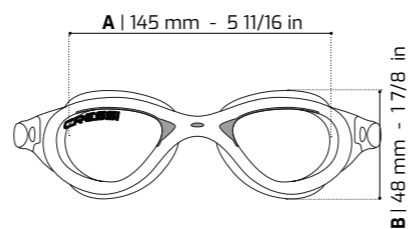

CODE	PRODUCT
DE202320	FLASH - BLUE/BLUE
DE202322	FLASH - CLEAR/CLEAR BLUE
DE202323	FLASH - CLEAR/CLEAR BLUE + AZURE LENS
DE202331	FLASH - CLEAR/WHITE + TINTED LENS
DE202350	FLASH - CLEAR/BLACK
DE202358	FLASH - CLEAR/RED
DE202391	FLASH - BLACK/RED
DE202392	FLASH - BLACK/BLACK + TINTED LENS

REUSABLE
PROTECTIVE BOX
13,5 x 21 cm
5 5/16 x 8 1/4 in



FLASH LADY

ADULT SIZE
COMFORTABLE & PERFORMANCE



LADY

The Flash Lady goggles are characterized by an elastic nose bridge, which allows for perfect adaptability to a large number of facial profiles. The lenses are slightly inclined at 18° to follow the natural shape of the human face and increase the field of view. They are also shatterproof and offer UV ray protection. An internal anti-fogging treatment prevents fog during use. The nose gasket is made with hypoallergenic, high-quality TPR to ensure comfort and a perfect seal. The double-strap is made of silicone to ensure a

perfect fit without over-tightening. The Cressi-patented buckle system makes adjusting the strap effortless. Easy replacement of strap and buckle system. The Flash are versatile goggles, ideal for recreational swimming and competition, as well as both indoor and outdoor use.

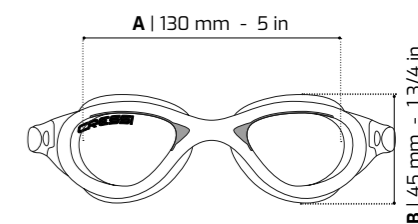

CODE	COLOR	LENSES
DE202950	BLACK/GRAY	TINTED
DE203020	CLEAR/BLUE	CLEAR
DE203040	CLEAR/PINK	CLEAR
DE203041	CLEAR/LILAC	CLEAR
DE203050	CLEAR/BLACK	CLEAR

REUSABLE
PROTECTIVE BOX
13,5 x 21 cm
5 5/16 x 8 1/4 in



RIGHT



The Right are prestigious goggles with slightly curved lenses on the outer profile, to offer maximum visibility. The gasket is made with hypoallergenic, high-quality TPR to ensure comfort and a perfect seal. The double-strap is made of silicone to ensure a perfect fit without over-tightening. The Cressi-patented buckle system makes adjusting the strap effortless. Easy replacement

of strap and buckle system. The lenses are anti-scratch resistant, 100% UV protection, and anti-fog treated. The Right are versatile goggles recommended for recreational swimming, as well as both indoor and outdoor use.

TECHNICAL FEATURES

- Eyes gaskets made of hypoallergenic, high-quality TPR
- Split strap made of soft and flexible silicone
- Micrometrically adjustable buckles easy to reach
- Flexible nose bridge for perfect adaptability to a large number of facial profiles
- Lenses: Inclined 18° anti fog, anti scratch, 100% anti UV
- Ideal for recreational swimming

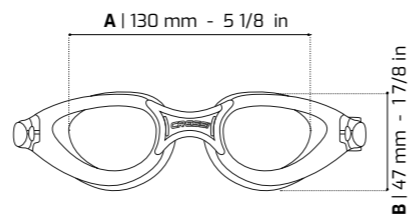

CODE	COLOR	LENSES
DE201621	BLUE/BLUE	CLEAR
DE201650	BLACK/BLACK	CLEAR
DE2016555	BLUE METAL	CLEAR
DE201660	CLEAR/CLEAR	CLEAR



REUSABLE PROTECTIVE BOX
13,5 x 21 cm
5 5/16 x 8 1/4 in

FOX



TECHNICAL FEATURES

- Flat lenses for perfect vision even at the edges
- Eyes gaskets made of hypoallergenic, high-quality TPR
- Split strap made of soft and flexible silicone
- Micrometrically adjustable buckles easy to reach
- Flexible nose bridge for perfect adaptability to a large number of facial profiles
- Lenses: Anti-fog, anti scratch, 100% anti UV
- Ideal for recreational swimming

The Fox goggles feature flat lenses for perfect vision, even at the edges. The gasket is made with hypoallergenic, high-quality TPR to ensure comfort and a perfect seal on most facial profiles. The double-strap is made of silicone to ensure a perfect fit without over-tightening. The Cressi-patented buckle system makes adjusting the strap effortless. Easy replacement of strap and buckle system. The lenses are anti-scratch resistant, 100% UV protection, and anti-fog treated. The Fox are versatile goggles recommended for recreational swimming, as well as both indoor and outdoor use.

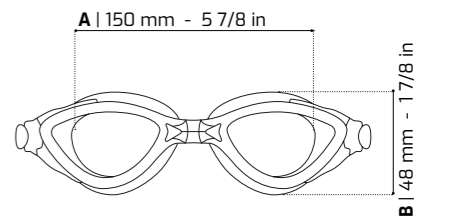

BLACK



CLEAR



LIGHT BLUE

CODE	COLOR	LENSES
DE202150	BLACK/BLACK	CLEAR
DE202160	CLEAR/CLEAR	CLEAR
DE202163	LIGHT BLUE/LIGHT BLUE	CLEAR



VORTEX NEW 2025

ADVANCED PERFORMANCE

VORTEX



TECHNICAL FEATURES

- Leak proof skirt for a universal fit
- Perfect for open water and recreational swimming
- Flexible nose bridge fits various facial profiles



EASY ADJUSTABLE BUCKLES

BUCKLES: Indestructible buckles, with micrometer system adjustment patented by Cressi. Easy to wear
U.S. PAT 5.956.778
 Device for regulating the length of a swimming goggles strap



STRAP:
 100%
 High quality
 silicone



Vortex are innovative swimming goggles designed to offer unparalleled comfort and versatility. Their unique construction is co-moulded with two materials: TPE and a semi-rigid compound for durability and strength. This combination of materials allows perfect adaptability to different facial profiles thanks to the elastic element integrated in the frame. The Vortex lenses are slightly curved on the outside to widen the field of vision,

maximising visibility under water. They are treated against scratches and have an anti-fog inner coating to ensure clear vision in all conditions. Vortex goggles are also equipped with micrometric adjustment buckles patented by Cressi for a long twenty years. These goggles are ideal for swimmers seeking the highest quality and functionality.

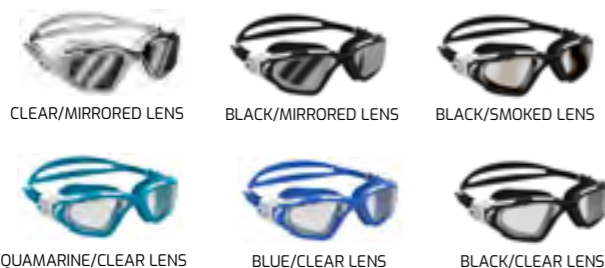

CLEAR/MIRRORED LENS BLACK/MIRRORED LENS BLACK/SMOKED LENS
 AQUAMARINE/CLEAR LENS BLUE/CLEAR LENS BLACK/CLEAR LENS

NUOTO 3.0

NUOTO 3.0



TECHNICAL FEATURES

- Antifog
- Quick-fit straps
- Wide view lenses
- Leakproof seal design
- 3 Adjustable nose bridges



INTERCHANGEABLE NOSE BRIDGE
 3 DIFFERENT SIZES INCLUDED



The Nuoto 3.0 swimming goggles mark an evolution in the Nuoto series, perfect for leisurely swimming. Designed for adults, these goggles feature a comfortable split silicone strap, with adjustable buckles and strap holders on each side. The lens shape ensures a secure fit, continuing the Cressi tradition of offering a high-quality product at an affordable price.



YELLOW/BLACK NAVY/NAVY PINK/CLEAR BLACK/BLACK MIRROR LENS

CODE	COLOR	STYLE
ZDE241050	YELLOW/BLACK	CLEAR
ZDE242424	NAVY/NAVY	CLEAR
ZDE244000	PINK/CLEAR	CLEAR
ZDE245059	BLACK/BLACK	MIRRORED LENS
ZDE245058	BLACK/BLACK	SMOKED LENS
ZDE240000	CLEAR/CLEAR	



BLISS



The Bliss swim goggles is an exciting product of the new 2024 line "BLUE by Cressi". The two eyepieces are designed to ensure a watertight seal. The silicone strap includes clips on each side in order to adjust the strap to the swimmer's preference. The Bliss is a simple and classic designed goggle that is suitable for all swimmers, regardless of skill level.

TECHNICAL FEATURES

- Adult swim goggles
- Clear lenses
- Silicone strap
- Clips for strap adjustment



ADJUSTABLE NOSE BRIDGE

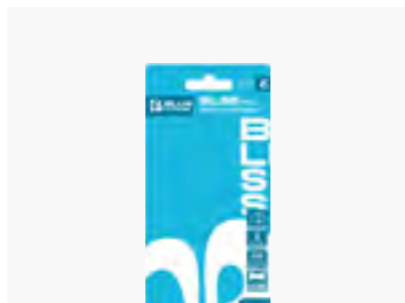
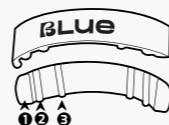

NAVY/NAVY WHITE/WHITE WHITE/AQUA GREEN BLACK/BLACK

CODE	COLOR
ZDE232424	NAVY/NAVY
ZDE233030	WHITE/WHITE
ZDE233063	WHITE/AQUA GREEN
ZDE235050	BLACK/BLACK

BLISS TRIPLE PACK (NAVY, WHITE, BLACK)

CODE
ZDE239931

FOR ALL SWIMMERS!

LIGHT

SPECIFICALLY DESIGNED FOR TRAINING AND BUILDING MUSCLES



TECHNICAL FEATURES

- Increased speed
- Improved leg strength and flexibility
- Improved body motion & position
- Improved racing technique
- Anatomic foot pocket
- Short blade



MAXIMUM FLEXIBILITY

The Light fins are specifically designed for pool use and for swim training, but can also be used adequately for recreational swimming and snorkeling. The short blade is made of a highly reactive and light material which guarantees agile and effective kicking without tiring out your legs. The length of the blade has been researched and

studied by Cressi to ensure perfect muscle training without causing cramps or discomfort. The anatomically designed foot pocket is made of soft rubber elastomers, and it houses the foot with a great deal of comfort, even during long swimming sessions.

CODE	SIZE	COLOR
DP182033	33/34	Blue
DP182035	35/36	Blue
DP182037	37/38	Blue
DP182039	39/40	Blue
DP182041	41/42	Blue
DP182043	43/44	Blue
DP182045	45/46	Blue

FIN SIZE	SIZE CONVERSION CHART			
	EU SIZE	UK SIZE	US MM SIZE	US WW SIZE
31/32	31 - 32	12 - 13 K	13 K - 1 Y	
33/34	33 - 34	1 - 2 Y	2 - 3 Y	
35/36	35 - 36	2 1/2 - 3 1/2	3 1/2 - 4 1/2	4 1/2 - 5 1/2
37/38	37 - 38	4 - 5	5 - 6	6 - 7
39/40	39 - 40	5 1/2 - 6 1/2	6 1/2 - 7 1/2	7 1/2 - 8 1/2
41/42	41 - 42	7 - 8	8 - 9	9 - 10
43/44	43 - 44	8 1/2 - 9 1/2	9 1/2 - 10 1/2	10 1/2 - 11 1/2
45/46	45 - 46	10 - 11	11 - 12	12 - 13

FIN SIZE	PRODUCT DIMENSION CHART			
	A	B	C	FIN WEIGHT
31/32	25.3 cm 10 in	15.0 cm 5 7/8 in	11.3 cm 4 1/2 in	218 g 7 1/2 oz
33/34	29.1 cm 11 1/2 in	16.1 cm 6 3/8 in	12.2 cm 4 7/8 in	237 g 8 oz
35/36	31.0 cm 12 1/4 in	16.5 cm 6 1/2 in	13.0 cm 4 3/4 in	258 g 9 oz
37/38	33.5 cm 13 1/4 in	17.0 cm 6 3/4 in	14.1 cm 5 1/2 in	279 g 10 oz
39/40	34.7 cm 13 7/8 in	17.5 cm 6 7/8 in	15.0 cm 5 7/8 in	298 g 11 oz
41/42	37.2 cm 14 7/8 in	18.5 cm 7 1/4 in	16.2 cm 6 3/8 in	335 g 12 oz
43/44	38.5 cm 15 1/8 in	19.0 cm 7 1/2 in	16.8 cm 6 5/8 in	384 g 13 1/2 oz
45/46	41.0 cm 16 1/8 in	19.5 cm 7.7 in	18.3 cm 7 1/4 in	409 g 14 1/2 oz

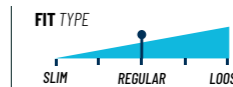
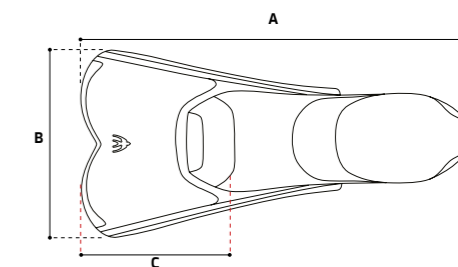

FINS COULD COME LABELED WITH EU AND UK SIZES ONLY
CRESSI'S SIZE CHART TO BE USED AS A REFERENCE ONLY

PURA

SILICONE SNORKELING & SWIMMING FINS



TECHNICAL FEATURES

- Versatility and comfort
- Intensive training
- 100% silicone



Pura swimming fins are made of highly versatile and comfortable silicone. These fins are designed for swimmers who wish to intensively train their legs and ankles, increasing strength in the abdominal and lumbar area. Made of 100% silicone, the Pura fins are easy to wear. This model of short fins best completes the Cressi line dedicated to swimming. All in all, these fins are great for family snorkel trips and will allow hours of underwater exploration.

CODE	SIZE	COLOR
XCA602035	XS	Blue/Azure
XCA602038	S	Blue/Azure
XCA602040	M	Blue/Azure
XCA602043	L	Blue/Azure
XCA602045	XL	Blue/Azure



SWIFT



NAVY/BLUE



WHITE/BLACK



WHITE/AQUA GREEN



WHITE/PINK



PACKAGING

CODE	STYLE	COLOR
ZDF232420	ADULT	NAVY/BLUE
ZDF233050	ADULT	WHITE/BLACK
ZDF233063	ADULT	WHITE/AQUA GREEN
ZDF233040	ADULT	WHITE/PINK
ZDF252420	DREADLOCKS	NAVY/BLUE
ZDF253063	DREADLOCKS	WHITE/AQUA GREEN

SUPER STRETCH



Cap made with a super stretch fabric, lightweight, dries quickly and offers UV protection. The fabric is comfortable for long hair without pulling or snagging. The elastic band at the base ensures a tight fit.



BLACK



PINK



YELLOW



BLUE

CODE	COLOR
USW040000B	BLUE
USW040000K	BLACK
USW040000P	PINK
XDF240010	YELLOW
XDF240080	RED
XDF240090	GREEN

SWIM BUOY

The Swim Buoy is a very hydrodynamic Swim Buoy, created with quality materials and components. It features a tapered design that improves the hydrodynamics, especially in case of blurred sea and wind. Red orange fluorine fabric for great visibility. It comes with a brilliant finish for an ideal slide. Internal compartment watertight with water tightness system specially effective with rigid soul. Inflator with safety closing screwing.



CODE
TA611981

COTTON FRAME

This beach towel is a great choice for your next getaway! Made of soft cotton, it's large enough to wrap around you and keep you warm and dry. It's perfect for a day in the sun or an evening by the pool. The lightweight material is easy to carry, and the vibrant colors will add a splash of style to your beach look. Whether you're soaking up some rays or taking a dip in the ocean, this beach towel is sure to be your go-to companion. Cotton is a natural material and it absorbs more than synthetic fabrics.

90 x 180 cm | 35.5 x 71 in.



RED SUNFLOWER TANGERINE

CODE	COLOR	SIZE
XVA906760	RED	90X180 cm
XVA906770	SUNFLOWER	90X180 cm
XVA906780	TANGERINE	90X180 cm

FAST DRYING

Cressi Fast Drying towel is ideal for all sports and every outdoor recreational activity, but also multi-use for daily life. Made of high-quality material, it does not fuzzle even after several washes. High absorbent, fast-drying, soft on the skin, so it can be used for kids. Ultra-light and compact, minimal pack size, ideal in a sports bag or backpack.



BLACK BLUE PACKAGING

CODE	COLOR	SIZE
XVA890020	BLUE	60X120 cm
XVA890050	BLACK	60X120 cm

H2O FROSTED



CODE	PRODUCT
XVA670626	600 ML (BLUE OCTOPUS)
XVA670627	600 ML (GREEN OCTOPUS)
XVA671020	1 L (BLUE)
XVA671025	1 L (BLACK OCTOPUS)
XVA671027	1 L (GREEN OCTOPUS)

H2O DOUBLE WALL



CODE	PRODUCT
XVA695051	500 ML (SILVER)
XVA697520	750 ML (BLUE)
XVA697551	750 ML (SILVER)

RUBBER COATED THERMAL FLASK



CODE	COLOR	SIZE
XVA708002	BLACK/BLUE	500 ml

AQUA KIT

NEW 2025

MADE OF HYPOALLERGENIC SILICONE



The Aqua Kit set provides optimal protection by preventing water from entering the ears and nose while swimming. Made from soft, high-quality silicone, both the ear plugs and nose clip offer a comfortable, secure fit for extended use. The ear plugs are designed to fit most ear shapes and come

attached to an elastic string for easy removal and added convenience. The set also includes a compact storage case, making it easy to keep your ear plugs and nose clip organized and ready for use. Ideal for swimmers of all levels, this set ensures a worry-free and comfortable experience in the water.



CODE
DF204050



DRY EAR PLUGS

NEW 2025

MADE OF HYPOALLERGENIC SILICONE

The Silicone Ear Plugs effectively prevent water from entering the ears while swimming, ensuring a comfortable and secure fit. Crafted from soft, high-quality silicone, these earplugs provide maximum comfort during use. Designed to fit most ear shapes, they come with an attached elastic string for easy removal and to prevent loss. Ideal for swimmers of all levels, these earplugs offer reliable protection while allowing you to enjoy your time in the water worry-free.

CODE
DF202050

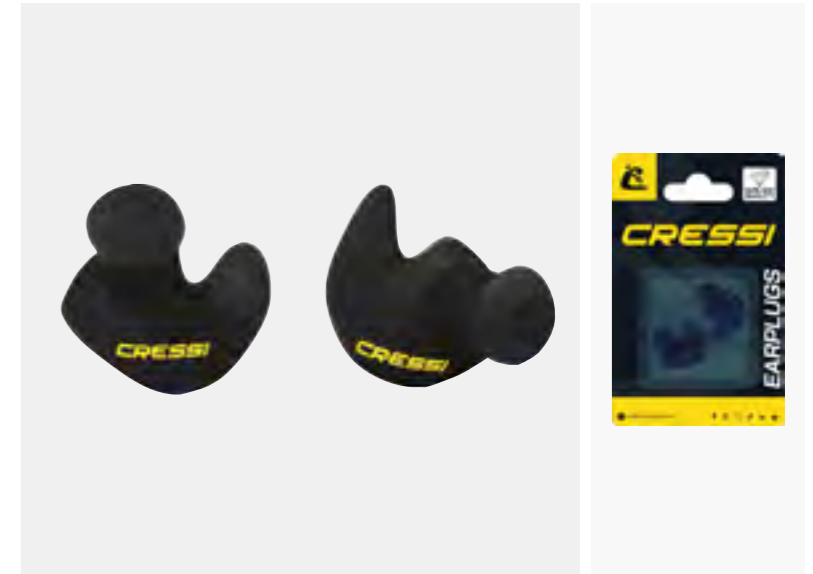

COMFORT NOSE CLIP

NEW 2025

MADE OF HYPOALLERGENIC SILICONE

The Comfort Nose Clip provides effective protection by preventing water from entering the nose while swimming. Crafted from soft, high-quality silicone, it ensures a secure yet comfortable fit, allowing swimmers to focus on their performance without discomfort. Perfect for swimmers of all levels, this nose clip offers a snug fit that stays in place, providing reliable protection during any water activity.

CODE
DF201050

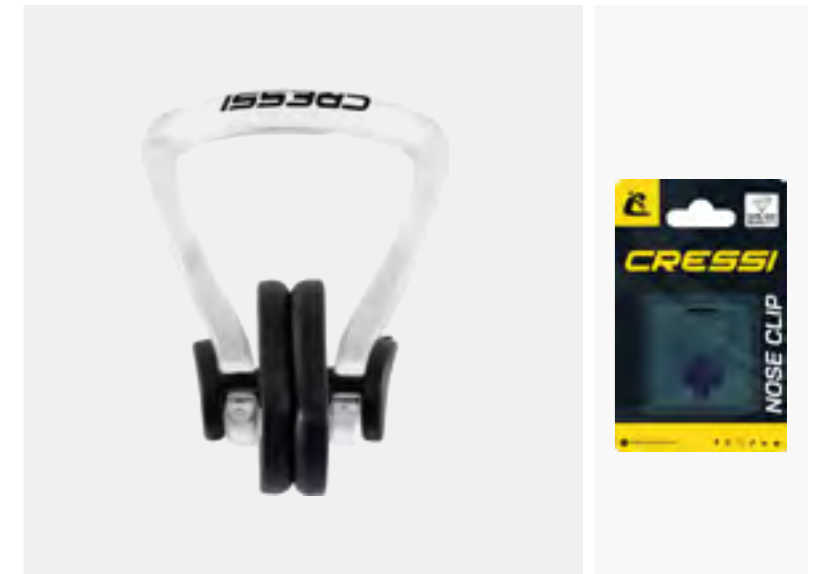

NOSE CLIP

The Nose Clip is a must-have for swim lovers. It prevents water from entering your nose while swimming. With a lightweight, waterproof design, this nose clip provides a low-profile, comfortable fit. Perfect for all kinds of training and competition but also for leisure. One size that fits both youth and adults. Includes a small case for easy storage.

CODE
DF200189



SWIMMING

KIDS

KIDS

MADE IN ITALY

CRESSI PATENTED TECHNOLOGIES
EASY ADJUSTABLE BUCKLES
U.S. PAT 5.956.778

CATALOG 2025 CRESSI

MINI COBRA



The Mini Cobra is designed for kids, for swimming and enjoying the sea. Made of silicone, a better and longer-lasting material than plastic PVC. This material is more comfortable and allows a perfect fit for most facial profiles. The mask is made with a single-piece skirt that is characterized by the presence of an elastic element within

the structure that allows a better fit than other goggles. The lenses are shatterproof and made with an Anti-Scratch, UV Protection, and internal Anti-Fog treatment.

TECHNICAL FEATURES

- Mask style swim goggles
- Skirt and strap made of hypoallergenic silicone
- Micrometrically adjustable buckles easy to reach
- Wide polycarbonate lenses
- Anti-UV, anti-fog, anti-scratch lenses
- Split strap

0	1	2	3	4	5	6	7	8	9	10	11	12	13	14	15	16
YEARS OLD																



CODE	COLOR
DE202021	LIGHT BLUE/LIME
DE202022	CLEAR/BLUE
DE202023	CLEAR/BLUE, BLUE LENS
DE202040	CLEAR/PINK
DE202067	CLEAR/LIME

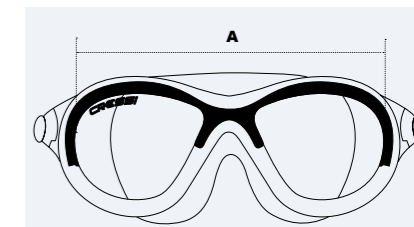

DIMENSION CHART	
A WIDTH	
120 mm • 4 3/4 in	
CRESSI'S SIZE CHART IS TO BE USED AS A REFERENCE ONLY	



KING BALOO



The King Baloo mono-lens goggle is designed for teens in order to allow any activity, also play, while maintaining excellent watertightness. The reduced skirt of its structure improves stability on the face as well as grip capacity.



CODE	COLOR
DE203720	BLUE/WHITE
DE203725	AQUAMARINE/WHITE
DE203740	PINK/WHITE
DE203741	LILAC/WHITE

TECHNICAL FEATURES

- U.S. Pat 5.956.778
- Total vision
- Micrometric adjustable buckles
- Ultra clear skirt
- 100% anti-UV lens
- Anti-scratch lens
- Anti-fog lens
- Age 7 - 15 years

0	1	2	3	4	5	6	7	8	9	10	11	12	13	14	15	16
YEARS OLD																

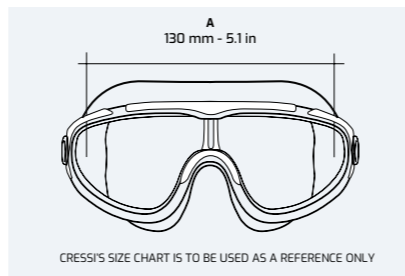

KING BALOO



BALOO



The Baloo is the best seller mask in the Cressi swim line for kids, designed with extreme comfort in mind. The mask has a flexible frame, a watertight fit, and easy adjusting buckles that make it the most comfortable and easy-to-use children's swim mask on the market today. It is perfect for swim lessons and is the ultimate in aquatic eye protection. Because the lenses are curved,

children do not feel claustrophobic. In addition, they are shatterproof, have an internal anti-fog treatment and are kid safe. The Baloo mask is the perfect solution for kids ready to experience the aquatic world.

TECHNICAL FEATURES

- Mask style swim goggles
- Skirt and strap made of hypoallergenic silicone
- Micrometrically adjustable buckles easy to reach
- Wide curved lens to ensure a wide view and prevent claustrophobia while underwater
- Anti-UV, anti-fog, anti-scratch lens
- Split strap

0	1	2	3	4	5	6	7	8	9	10	11	12	13	14	15	16
YEARS OLD																

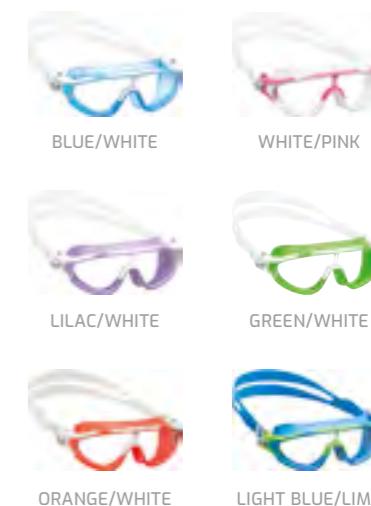

CODE	COLOR
DE203220	WHITE/BLUE
DE203222	LIGHT BLUE/LIME
DE203240	WHITE/PINK
DE203241	LILAC/WHITE
DE203267	GREEN/WHITE
DE203285	ORANGE/WHITE

CODE	PRODUCT
DZ301030	SWIM GOGGLES SILICONE STRAP WHITE

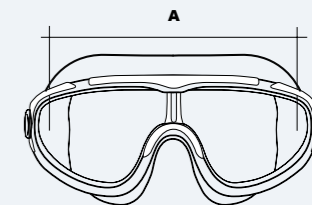

DIMENSION CHART

A | WIDTH

117 mm • 4 5/8 in

CRESSI'S SIZE CHART IS TO BE USED AS A REFERENCE ONLY



KING CRAB



The sophisticated design of the King Crab goggles features uniquely shaped flat lenses that combine fashionable style with perfect vision underwater. The lenses are shatterproof and feature external anti-scratch treatment, UV protection, and internal anti-fog treatment. The King Crab goggles feature comfortable

TPR gaskets which form a watertight seal on the eyes and fit most facial profiles. The silicone strap and micro-adjustable buckles system are interchangeable with all the other masks and goggles in the Cressi Swim Line.

TECHNICAL FEATURES

- Skirt made of high-quality TPR
- Split strap made of soft silicone
- Soft flexible nose bridge
- Slightly curved lenses for peripheral vision
- Anti-UV, anti-fog, anti-scratch lens
- Micrometrically adjustable buckles easy to reach

0	1	2	3	4	5	6	7	8	9	10	11	12	13	14	15	16
YEARS OLD																

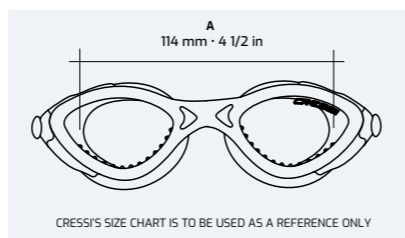

CODE	COLOR
DE202240	PINK
DE202241	LILAC
DE202260	CLEAR
DE202263	LIGHT BLUE
DE202267	LIME/WHITE

SPARE PARTS	
CODE	PRODUCT
DZ300060	BUCKLES CLEAR FOR SWIM GOGGLES
DZ301020	SWIM GOGGLES SILICONE STRAP BLUE
DZ301030	SWIM GOGGLES SILICONE STRAP WHITE
DZ301040	SWIM GOGGLES SILICONE STRAP PINK
DZ301050	SWIM GOGGLES SILICONE STRAP BLACK
DZ301060	SWIM GOGGLES SILICONE STRAP CLEAR

KING CRAB

ROCKS



The Rocks are designed for young swimmers that need comfortable swim goggles for prolonged use.

They feature a classic round lens shape that is also slightly curved for excellent peripheral vision. Lenses feature external anti-scratch treatment, UV protection and internal anti-fog treatment. TPR gaskets around the lenses form a comfortable, watertight seal. 100% hypoallergenic silicone strap for maximum comfort and

fit. Strap and buckles are interchangeable with all other Cressi goggles and masks in the swim line. Offered in a variety of colors and lens tints, including a mirror lens version with black silicone.

TECHNICAL FEATURES

- Skirt made of high-quality TPR
- Split strap made of soft silicone
- Soft flexible nose bridge
- Slightly curved lenses for peripheral vision
- Anti-UV, anti-fog, anti-scratch lens
- Micrometrically adjustable buckles easy to reach

0	1	2	3	4	5	6	7	8	9	10	11	12	13	14	15	16
YEARS OLD																

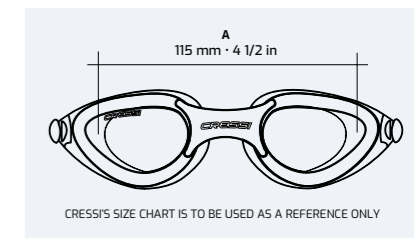

CODE	COLOR
DE201321	BLUE/BLUE
DE201322	AZURE/AZURE
DE201332	WHITE/BLUE
DE201334	WHITE/PINK
DE201340	PINK/PINK
DE201360	CLEAR/CLEAR

SPARE PARTS	
CODE	PRODUCT
DZ300060	BUCKLES CLEAR FOR SWIM GOGGLES
DZ301020	SWIM GOGGLES SILICONE STRAP BLUE
DZ301030	SWIM GOGGLES SILICONE STRAP WHITE
DZ301060	SWIM GOGGLES SILICONE STRAP CLEAR



ROCKS

CRAB



TECHNICAL FEATURES

- Skirt made of high-quality TPR
- Split strap made of soft silicone
- Soft flexible nose bridge
- Slightly curved lenses for peripheral vision
- Anti-UV, anti-fog, anti-scratch lens
- Micrometrically adjustable buckles easy to reach

0	1	2	3	4	5	6	7	8	9	10	11	12	13	14	15	16
YEARS OLD																



Sophisticated silicone goggles designed for children aged approximately between 2 and 7 years old. Completely flat lenses for perfect vision, even at the edges. Ideal for swim lessons. Shatterproof lenses with UV protection and scratch-resistant external treatment and internal anti-fog treatment.

Cressi high technology for a perfect fit on most facial profiles and with great comfort. Interchangeable strap with patented micrometric, quick and easy adjustable buckles, similar to Cressi diving masks.

CODE	COLOR
DE203120	BLUE
DE203122	MATTE BLUE
DE203140	PINK
DE203141	LILAC
DE203167	LIME

SPARE PARTS	
CODE	PRODUCT
DZ300060	BUCKLES CLEAR FOR SWIM GOGGLES
DZ301020	SWIM GOGGLES SILICONE STRAP BLUE
DZ301030	SWIM GOGGLES SILICONE STRAP WHITE
DZ301040	SWIM GOGGLES SILICONE STRAP PINK
DZ301041	SWIM GOGGLES SILICONE STRAP LILAC
DZ301050	SWIM GOGGLES SILICONE STRAP BLACK
DZ301060	SWIM GOGGLES SILICONE STRAP CLEAR

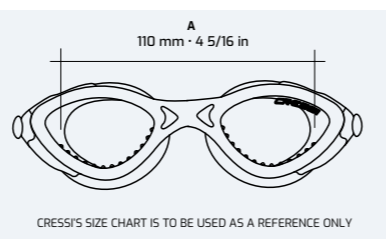

CRAB

DOLPHIN 2.0



TECHNICAL FEATURES

- Flat lens for perfect vision
- Shatterproof lenses
- Scratch resistant external treatment
- Internal anti-fog treatment

0	1	2	3	4	5	6	7	8	9	10	11	12	13	14	15	16
YEARS OLD																

The Dolphin 2.0 are colorful goggles made for making your children happy. They're made with quality material to ensure comfort and a perfect seal. The goggles feature easy to use buckles for adjusting the length of the strap. They come with a reusable protective box.



CODE	COLOR
USG010210	AZURE/YELLOW
USG010220	AZURE/BLUE
USG010240	AZURE/PINK
USG010430	LILAC/WHITE

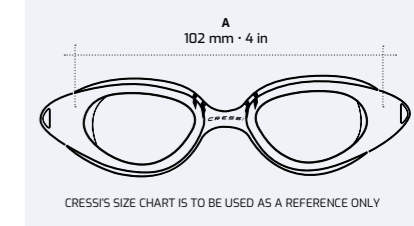

DOLPHIN 2.0

SEAHORSE



Ideal for smaller faces, this classic swim goggle features soft silicone gaskets, a split silicone head strap and fog/UV protection. The Seahorse children's goggles show ease to adjust side clips and an incremental size adjustable nose-piece that allows for custom fitting and comfort on the face.

TECHNICAL FEATURES

- Flat lens for perfect vision
- Shatterproof lenses
- Scratch resistant external treatment
- Internal anti-fog treatment

0	1	2	3	4	5	6	7	8	9	10	11	12	13	14	15	16
YEARS OLD																



BLUE/WHITE/RED



PURPLE/PINK



GREEN/AZURE



GREEN/WHITE/RED

CODE	COLOR
XDE022038	BLUE/WHITE/RED
XDE023040	PURPLE/PINK
XDE029022	GREEN/AZURE
XDE029038	GREEN/WHITE/RED



SEA HORSE

STARFISH



The Cressi Starfish is an ideal goggle for younger children. This classic swim goggle features soft silicone gaskets, a split silicone head strap, and fog/UV protection. The Starfish goggles have easy to adjust side clips and an incremental size adjustable nose-piece that ensures a custom and comfortable fit. Ideal for kids aged 4 to 8 years old.

TECHNICAL FEATURES

- Anti-fog
- Panoramic lenses
- Cushioned silicone seals

0	1	2	3	4	5	6	7	8	9	10	11	12	13	14	15	16
YEARS OLD																



BLUE/AZURE



GREEN/AZURE



ORANGE/AZURE



WHITE/PINK

CODE	COLOR
XDE032022	BLUE/AZURE
XDE033040	WHITE/PINK
XDE038022	ORANGE/AZURE
XDE039022	GREEN/AZURE



ADJUSTABLE NOSE BRIDGE



STAR FISH

PIUMETTA

AGE 3-7



Piumetta is the mask especially made for young people that love to discover the underwater world. It is particularly suitable for snorkeling and swimming. It has separated polycarbonate lenses, a soft face skirt, with internal seal ring that fits to most facial contours, providing a high level of comfort. The internal volume is very small, good for going deep underwater. It is made from soft transparent silicone, and comes with strong rapid action buckles to adjust the strap.

TECHNICAL FEATURES

- Mono-lens style mask
- Polycarbonate lens
- Micrometric adjustable buckles
- Double feathered skirt edge
- Skirt and strap made of hypoallergenic silicone
- Split strap

0	1	2	3	4	5	6	7	8	9	10	11	12	13	14	15	16
YEARS OLD																



CODE	COLOR
DN200510	CLEAR/YELLOW
DN200520	CLEAR/BLUE
DN200540	CLEAR/PINK
DN200563	CLEAR/AQUA

SPARE PARTS

CODE	PRODUCT
DZ210005	Buckles Black Pair for Onda/Ondina/Perla/Pumetta/Sirena
DZ210040	Silicone Strap Clear for Sea Line Masks
DZ210042	Silicone Strap Black for Sea Line Masks

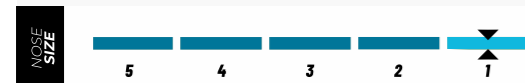
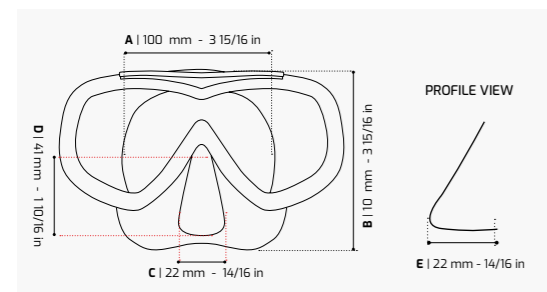

CRESSI'S SIZE CHART IS TO BE USED AS A REFERENCE ONLY



PIUMETTA

MOON

AGE 5-10



The Moon is a small mask suitable for children. The mask is really more comfortable, compared to the traditional swim goggles, and are ideal to be used in the swimming pool even in the sea with a snorkel. The two lenses have a design that follows the natural shape of the face drastically increasing the field of view. They are made with anti-scratch and anti-fog treatment. They also protect the eyes against the dangerous UV sun rays.

The skirt is made of hypoallergenic TPR, a soft material that ensures comfort. The front frame is made of very flexible plastic and, in combination with the TPR, the mask ensures

a perfect seal and adapts to most shape faces. The nose pocket is easy-to-reach for ear equalization if the child swims below the surface of the water.

The buckles are the same used in the Cressi premium scuba diving mask and allow the user to easily adjust the strap length without effort.

TECHNICAL FEATURES

- Swim mask style
- Polycarbonate lens
- Micrometric adjustable buckles
- Skirt and strap made of hypoallergenic silicone
- Split strap

0	1	2	3	4	5	6	7	8	9	10	11	12	13	14	15	16
YEARS OLD																



CODE	COLOR
DN200620	CLEAR/AZURE
DN200641	CLEAR/LILAC
DN200667	CLEAR/LIME
DN200720	LIGHT BLUE/LIME
DN200740	PINK/LILAC

SPARE PARTS

CODE	PRODUCT
DZ300060	BUCKLES CLEAR FOR SWIM GOGGLES
DZ301020	SWIM GOGGLES SILICONE STRAP BLUE
DZ301040	SWIM GOGGLES SILICONE STRAP PINK
DZ301060	SWIM GOGGLES SILICONE STRAP CLEAR

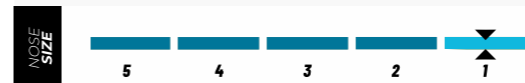
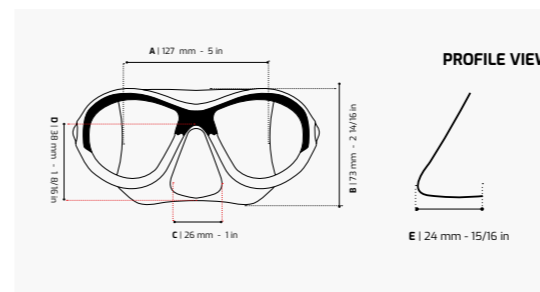

CRESSI'S SIZE CHART IS TO BE USED AS A REFERENCE ONLY



MOON

MINI LIGHT

SHORT KIDS FINS



The Mini Light will make learning to swim easy and fun for your child! Short kids fins made of high-quality rubber to ensure a proper comfort and fit. Designed for a daily use, flexible, comfortable and almost indestructible.

The easy-to-use tab makes the fin easy to put on and take off. Ideal fins that help to develop leg strength and endurance.

TECHNICAL FEATURES

- Made of natural rubber (no latex)
- Soft and durable
- Floats on water
- Ideal for learning to swim

0	1	2	3	4	5	6	7	8	9	10	11	12	13	14	15	16
YEARS OLD																

CODE	COLOR	SIZE
DP301023	YELLOW	23/24
DP301025	YELLOW	25/28
DP301029	YELLOW	29/31
DP301032	YELLOW	32/33
DP301034	YELLOW	34/35
DP302123	AZURE	23/24
DP302125	AZURE	25/28
DP302129	AZURE	29/31
DP302132	AZURE	32/33
DP302134	AZURE	34/35
DP304023	PINK	23/24
DP304025	PINK	25/28
DP304029	PINK	29/31
DP304032	PINK	32/33
DP304034	PINK	34/35
DP308523	ORANGE	23/24
DP308525	ORANGE	25/28
DP308529	ORANGE	29/31
DP308532	ORANGE	32/33
DP308534	ORANGE	34/35



PRODUCT DIMENSION CHART			
FIN SIZE	EU FOOT SIZE	US FOOT SIZE	KID'S AGE
23 / 24	23 / 24	6 / 7.5 K	1/2 YEARS
25 / 28	25 / 28	8 / 11 K	2/5 YEARS
29 / 31	29 / 31	11.5 / 13 K	4/6 YEARS
32 / 33	32 / 33	13.5 K / 1 Y	6/7 YEARS
34 / 35	34 / 35	2 / 3 Y	8/9 YEARS

To maximize performance and comfort, wear fins with:

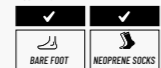

FIT SIZE



FINS COME LABELED WITH EU AND UK SIZES ONLY. CRESSI'S SIZE CHART IS TO BE USED AS A REFERENCE ONLY.

BLOWFISH

WATERSHOES



The Blowfish sock serves as an ideal safeguard for toddlers' feet during activities like swimming, paddling, and snorkeling. Featuring anti-slip dots on the soles for protection against abrasions and scratches, these socks include upper drainage perforations to efficiently remove water. Made from neoprene, they offer a stretchy, warm, and cozy fit for added comfort.

TECHNICAL FEATURES

- Made from super-stretch neoprene
- Ideal for swimming pools, paddling, and snorkeling
- Anti-slip soles
- Drain holes on top for removal of water inside
- Quick drying

0	1	2	3	4	5	6	7	8	9	10	11	12	13	14	15	16
YEARS OLD																

CODE	COLOR	SIZE
VB012220	AZURE	20/22
VB012223	AZURE	23/24
VB014020	PINK	20/22
VB014023	PINK	23/24



SIZE CHART				
SOCK SIZES	US SIZE	KIDS AGE	FOOT LENGTH cm	FOOT LENGTH INCHES
20/22	4 / 5.5	0-1 YEARS	12.3 cm - 13cm	4" 7/8 - 5" 1/8
23/24	6 / 7.5	1-2 YEARS	3.3 cm - 14.6 cm	5" 1/4 - 5" 3/4

USA 12/2023 CRESSI'S SIZE CHART TO BE USED AS A REFERENCE ONLY

FIT SIZE

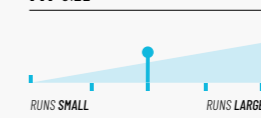

ANTI-SLIP SOLES



KIDS SWIMSUIT LONG SLEEVE

ONE-PIECE SWIMSUIT FOR CHILDREN. MADE WITH 1.5mm THICK NEOPRENE



TECHNICAL FEATURES

- One-piece swimsuit for children
- 85% Neoprene + 15% Elastane.
- Easy to wear thanks to the Easy YKK front zip.
- Protection from cold and against the UV ray from the sun.
- Offer a good protection against Jellyfish.

0	1	2	3	4	5	6	7	8	9	10	11	12	13	14	15	16
YEARS OLD																

85% NEOPRENE
+ 15% ELASTANE

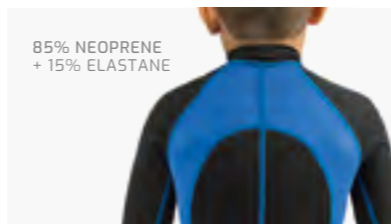

YKK
FRONT ZIP

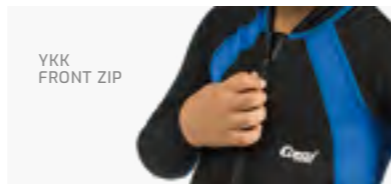

SHORT
PANTS

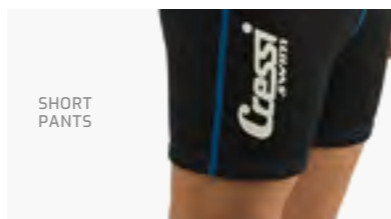

SUN & COLD
PROTECTION



JELLYFISH
PROTECTION



One-piece swimsuit for children. Made with 1.5mm thick neoprene (front and back) and Elastane (sides, sleeves and collar). Easy YKK front zip. Offers excellent protection from the cold and the sun, and maximum freedom of movement thanks to the areas in Elastane that won't irritate the skin while swimming. Offer a good protection against Jellyfish. High quality Thermal protection that keeps the kid warm for prolonged water exposure.

CODE	COLOR	SIZE
WDG001501	BLACK/BLUE	S
WDG001502	BLACK/BLUE	M
WDG001503	BLACK/BLUE	L
WDG001504	BLACK/BLUE	XL
WDG001505	BLACK/BLUE	2XL
WDG001541	BLACK/PINK	S
WDG001542	BLACK/PINK	M
WDG001543	BLACK/PINK	L
WDG001544	BLACK/PINK	XL
WDG001545	BLACK/PINK	2XL

SIZE CHART

SIZE	AGE	WEIGHT (LB)	WEIGHT (KG)	HEIGHT (IN)	HEIGHT (CM)
S	1 - 2	22 - 29 lb	10.0 - 13.1 kg	30 - 33 in	76.2 - 83.8 cm
M	3 - 4	29 - 46 lb	13.1 - 20.9 kg	33 - 43 in	83.2 - 109.2 cm
L	5 - 6	46 - 57 lb	20.9 - 25.6 kg	43 - 47 in	109.2 - 119.4 cm
XL	7 - 8	57 - 71 lb	25.6 - 32.2 kg	47 - 53 in	119.4 - 134.6 cm
2XL	9 - 10	71 - 85 lb	32.2 - 38.6 kg	53 - 57 in	134.6 - 144.8 cm

CRESSI'S SIZE CHART TO BE USED AS A REFERENCE ONLY

KIDS SWIMSUIT SHORT SLEEVE

ONE-PIECE SWIMSUIT FOR CHILDREN. MADE WITH 1.5mm THICK NEOPRENE



TECHNICAL FEATURES

- One-piece swimsuit for children
- 85% Neoprene + 15% Elastane.
- Easy to wear thanks to the Easy YKK front zip.
- Protection from cold and against the UV ray from the sun.
- Offer a good protection against Jellyfish.

0	1	2	3	4	5	6	7	8	9	10	11	12	13	14	15	16
YEARS OLD																

85% NEOPRENE
+ 15% ELASTANE

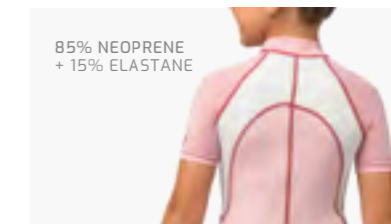

YKK
FRONT ZIP

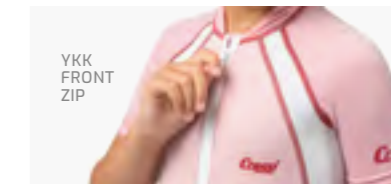

SHORT
PANTS

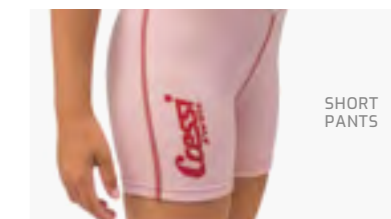

SUN & COLD
PROTECTION



JELLYFISH
PROTECTION

One-piece swimsuit for little children ideal for any kind of water activity. It is a must-have for the swimming pool or to go snorkeling in the sea. The sides, the collar, and the sleeves are made of Elastane, an elastic fabric that works like a second skin, protecting against the harmful sun ray (UVA - UVB) and jellyfishes. The front and the back part are made of 1.5 mm Neoprene to ensure warmth and to offer an extra protection against cold, perfect in case of prolonged water exposure or in windy days. The front zip

(made of the quality YKK) makes easy the donning and doffing. The Swimsuit is designed for kids between 2 to 10 years old, refer to the size chart to get approximately the most suitable size for the child. The product is like a second skin, it is normal to feel it tight when worn. Rinse with clear water and let completely dry after use.

CODE	COLOR	SIZE
DG001001	BLUE/AZURE	S
DG001002	BLUE/AZURE	M
DG001003	BLUE/AZURE	L
DG001004	BLUE/AZURE	XL
DG001005	BLUE/AZURE	2XL
DG001101	PINK	S
DG001102	PINK	M
DG001103	PINK	L
DG001104	PINK	XL
DG001105	PINK	2XL

SIZE CHART

SIZE	AGE	WEIGHT (LB)	WEIGHT (KG)	HEIGHT (IN)	HEIGHT (CM)
S	1 - 2	22 - 29 lb	10.0 - 13.1 kg	30 - 33 in	76.2 - 83.8 cm
M	3 - 4	29 - 46 lb	13.1 - 20.9 kg	33 - 43 in	83.2 - 109.2 cm
L	5 - 6	46 - 57 lb	20.9 - 25.6 kg	43 - 47 in	109.2 - 119.4 cm
XL	7 - 8	57 - 71 lb	25.6 - 32.2 kg	47 - 53 in	119.4 - 134.6 cm
2XL	9 - 10	71 - 85 lb	32.2 - 38.6 kg	53 - 57 in	134.6 - 144.8 cm

CRESSI'S SIZE CHART TO BE USED AS A REFERENCE ONLY



SWIFTY KID

SWIM CAP FROM 4 TO 8 YEARS



The Swifty swim cap offers adult and young swimmers a vibrant appearance with its hypoallergenic silicone material, providing a comfortable, durable fit that can endure chlorine and aging effects. It's a standout choice for resilient and budget-friendly swim cap seekers.

CODE	COLOR
ZDF242422	NAVY/AZURE
ZDF243820	WHITE/RED/BLUE
ZDF244440	PURPLE/PINK
ZDF249380	GREEN/WHITE/RED



0	1	2	3	4	5	6	7	8	9	10	11	12	13	14	15	16
YEARS OLD																

GOGGLE STRAP COVER

MAKES THE SWIM GOGGLE FLOAT ON THE WATER SURFACE



Soft neoprene strap cover for goggles with colorful graphics. The strap easily slides onto all Cressi swim goggles to hold the goggle in place while in use. Also protects from hair pulling. Buoyant component prevents goggles from being lost while in the water.



CODE	COLOR
D5339980	PINK/PURPLE
D5339982	AZURE/BLUE
D5339985	PURPLE/PINK
D5339986	LIME/GREEN

TECHNICAL FEATURES

- Soft neoprene strap cover for goggles with colorful graphics.
- Easily slides onto all Cressi swim goggles to hold the goggle in place while in use.
- Made in Neoprene ideal material for use underwater, both in the sea and in the swimming pool.
- Protects from hair pulling.
- Floats on the surface of the water.

0	1	2	3	4	5	6	7	8	9	10	11	12	13	14	15	16
YEARS OLD																



BABALOO REUSABLE DIAPER



TECHNICAL FEATURES

- Reusable swim diaper
- Comfortable fit
- Won't irritate the skin while swimming
- Sun ray protection: UV 50+

0	1	2	3	4	5	6	7	8	9	10	11	12	13	14	15	16
YEARS OLD																



SUN & COLD PROTECTION



MANDATORY IN SWIMMING POOL CLASSES!



NEW IMPROVED INTERNAL ABSORBENT FABRIC. HYPOALLERGENIC AND WASHABLE.



BLUE



PINK

The Babaloo reusable swim diaper is so cute, and it is a requirement to attend swim lessons and all water-related activities. Don't need an additional diaper. It will help the baby feel protected and babies have a reusable swim diaper that fits comfortably while enjoying time in the water. It is ideal for swim lessons. Nothing ruins learning to swim like having an accident while in the pool or poolside. The diaper's elastic waist and leg bands and waistband-drawstring provide a snug and secure fit without the discomfort of a diaper that is too small. This stops

from leaking out of the diaper in case of an accident. This prevents embarrassment from the child as well as a lengthy cleanup from pool staff. It offers an excellent protection from cold and sun: UV 50+ UPF protection. The plush material is comfy for the bottom and the legs and waist sides are super stretchy. Cressi has a helpful size chart to choose the right size.

CODE	COLOR	SIZE
USD030100B	BLUE	XS
USD030101B	BLUE	S
USD030102B	BLUE	M
USD030103B	BLUE	L
USD030104B	BLUE	XL
USD030105B	BLUE	2XL (3T-4T)
USD030106B	BLUE	3XL (4T-5T)
USD040100P	PINK	XS
USD040101P	PINK	S
USD040102P	PINK	M
USD040103P	PINK	L
USD040104P	PINK	XL
USD040105P	PINK	2XL (3T-4T)
USD040106P	PINK	3XL (4T-5T)

SIZE CHART					
SIZE	MONTHS	WEIGHT	WEIGHT	HEIGHT	HEIGHT
XS	3-6	6 - 12 lb	2.7-5.4 kg	25-27 in	63.5-68.6 cm
S	6 - 9	9 - 18 lb	4.1 - 8.2 kg	27-29 in	68.6-73.7 cm
M	9 - 12	15 - 24 lb	6.8-10.9 kg	29-31 in	73.7-78.7 cm
L	12 - 18	22 - 29 lb	10.0-13.6 kg	31-33 in	78.7-83.8 cm
XL	18 - 24	26 - 33 lb	11.8-15.0 kg	33-35 in	83.8-88.9 cm
3T-4T	24 - 36	31 - 40 lb	14.1-18.1 kg	35-38 in	88.9-94.0 cm
4T-5T	36 - 48	38 - 46 lb	17.2-20.9 kg	38 in +	94.0-99.1 cm

CRESSI'S SIZE CHART TO BE USED AS A REFERENCE ONLY



SUMBA XL



TECHNICAL FEATURES

- Durable, tear-resistant fabric
- Water-repellent, stain-resistant fabric
- Lightweight and roomy
- Ventilated main compartment
- Volume: 25 L | 0.88 cu ft
- Dimensions: 40 x 70 cm | 15.7 x 27.5 in

EASY CLOSURE



FRONT POCKET

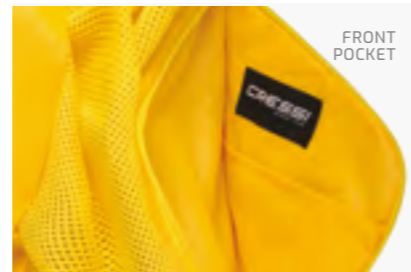

Sporty 25 Liters bag that's perfect for all activities and free time. Made in durable tear-resistant fabric with water-repellent and stain-resistant properties. Light and roomy, with cord closure and ample ventilated main compartment for clothing, an outer pocket for accessories, and zip closure.



LIGHT BLUE



YELLOW

CODE	COLOR
XUB950210	YELLOW
XUB950222	LIGHT BLUE





SUPPORT

AVAILABLE FULL FACE MASK
WALL DISPLAY

CODE	PRODUCT
------	---------

SPARE PARTS

PLEASE ALSO REFER TO THE CRESSI SPARE PARTS CATALOG FOR FURTHER INFORMATION AND TECHNICAL DETAILS

FULLFACE MASK PARTS

CODE	PRODUCT
------	---------

XDZ500001	COMPLETE SNORKEL FOR BARON, BARON JR, DUKE, KNIGHT (CLEAR)
XDZ500002	COMPLETE SNORKEL FOR BARON, BARON JR, DUKE, KNIGHT (BLACK)
XDZ500009	MOUTH COVER FOR BARON, BARON JR, DUKE, KNIGHT (BLACK)
XDZ500010	MOUTH COVER FOR BARON, BARON JR, DUKE, KNIGHT (GREY)
XDZ500012	SILICONE VALVES KIT FOR BARON, BARON JR, DUKE, KNIGHT
XDZ500300	COMPLETE SNORKEL FOR BARON JR (CLEAR/CLEAR)
XDZ500302	ELASTIC STRAP FOR BARON/BARON JR (GREY)

MASK PARTS

CODE	PRODUCT
------	---------

DZ271030	BUCKLES FOR PEGASO - YELLOW/WHITE
DZ272030	BUCKLES FOR PEGASO - BLUE/WHITE
DZ274130	BUCKLES FOR PEGASO - LILAC/WHITE

SNORKEL PARTS

CODE	PRODUCT
------	---------

DZ271030	BUCKLES FOR PEGASO (YELLOW/WHITE)
DZ272030	BUCKLES FOR PEGASO (BLUE/WHITE)
DZ274130	BUCKLES FOR PEGASO (LILAC/WHITE)
EZ269030	SNORKEL KEEPER FOR IGUANA/IGUANA DRY (WHITE)
EZ271020	MOUTHPIECE FOR IGUANA/IGUANA DRY (CLEAR/BLUE)
EZ271041	MOUTHPIECE FOR IGUANA/IGUANA DRY (CLEAR/LILAC)
USZ631000	MOUTHPIECE FOR ISLAND SNORKEL (CLEAR)
USZ631050	MOUTHPIECE FOR ISLAND SNORKEL (BLACK)

FINS PARTS

CODE	PRODUCT
------	---------

CZ242030	STRAP & BUCKLES ASSEMBLY FOR BONETE/MINI BONETE/ROCKS (BLUE/WHITE)
CZ244130	STRAP & BUCKLES ASSEMBLY FOR BONETE/MINI BONETE/ROCKS (LILAC/WHITE)
USZ100020	STRAP & BUCKLES ASSEMBLY FOR BONETE/TONGA (BLACK/BLUE)
USZ100041	STRAP & BUCKLES ASSEMBLY FOR BONETE/TONGA (BLACK/PURPLE)
USZ100050	STRAP & BUCKLES ASSEMBLY FOR BONETE/TONGA (BLACK/BLACK)

SWIM GOGGLES PARTS

CODE	PRODUCT
------	---------

DZ300006	STRAP (CLEAR) FOR MINIMA/GALILEO
DZ300050	BUCKLES FOR SWIM GOGGLES (BLACK)
DZ300060	BUCKLES FOR SWIM GOGGLES (CLEAR)
DZ301020	STRAP FOR SWIM GOGGLES (BLUE)
DZ301030	STRAP FOR SWIM GOGGLES (WHITE)
DZ301040	STRAP FOR SWIM GOGGLES (PINK)
DZ301041	STRAP FOR SWIM GOGGLES (LILAC)
DZ301050	STRAP FOR SWIM GOGGLES (BLACK)
DZ301051	STRAP FOR SWIM GOGGLES (GREY)
DZ301060	STRAP FOR SWIM GOGGLES (CLEAR)

MEN'S WETSUITS DIMENSION CHART

SIZE	WEIGHT		A - HEIGHT		B - CHEST		C - WAIST		D - HIP	
	kg	lb	cm	in	cm	in	cm	in	cm	in
XS: 36/46	50-58	110-128	156-165	5' 1" - 5' 5"	70-75	28-30	59-65	23-26	72-77	28-30
S: 38/48	60-68	132-150	164-173	5' 5" - 5' 8"	78-83	31-33	65-71	25-28	78-83	31-33
M: 40/50	70-78	154-172	169-178	5' 7" - 5' 10"	86-91	34-36	71-77	28-30	84-89	33-35
L: 42/52	80-88	176-194	174-183	5' 9" - 6' 0"	94-99	37-39	77-83	30-33	90-95	35/37
XL: 44/54	90-98	198-216	179-188	5' 10" - 6' 2"	102-107	40-42	83-89	33-35	96-101	38-40
2XL: 46/56	100-108	220-238	184-193	6' 0" - 6' 4"	110-115	43-45	89-95	35-37	102-107	40-42
3XL: 48/58	105-115	231-254	191-198	6' 3" - 6' 6"	118-123	46-48	95-101	37-40	108-113	43-45

CRESSI'S SIZE CHART TO BE USED AS A REFERENCE ONLY



WOMEN'S WETSUITS DIMENSION CHART

SIZE	WEIGHT		A - HEIGHT		B - CHEST		C - WAIST		D - HIP	
	kg	lb	cm	in	cm	in	cm	in	cm	in
XS: 8/42	47-52	104-115	160-165	5' 3" - 5' 5"	77-82	30-32	56-61	22-24	83-87	32-34
S: 10/44	53-58	117-128	165-170	5' 5" - 5' 7"	82-87	32-34	60-65	24-26	87-91	34-36
M: 12/46	59-64	130-141	170-175	5' 7" - 5' 9"	87-92	34-36	64-69	25-27	91-95	36-37
L: 14/48	64-70	141-154	175-180	5' 9" - 5' 11"	92-97	36-38	68-73	27-29	95-99	37-39
XL: 16/50	70-80	154-176	180-185	5' 11" - 6' 1"	97-102	38-40	72-77	28-30	99-103	39-41
2XL: 18/52	80-90	176-198	185-190	6' 1" - 6' 3"	102-107	40-42	76-81	30-32	103-107	40.5-42

CRESSI'S SIZE CHART TO BE USED AS A REFERENCE ONLY

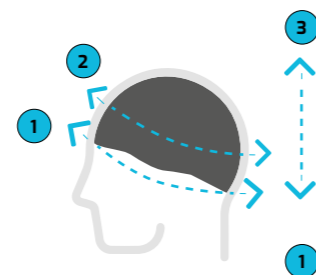
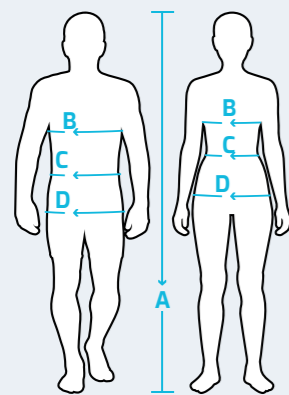

SWIFTY SWIM CAP

SIZE	BASE CIRCUMFERENCE	LENGTH CIRCUMFERENCE	CAP HEIGHT
S (SMALL) IDEAL FOR KIDS	21.5 in 54 cm	26 in 66 cm	7 in 18 cm
L (LARGE) IDEAL FOR ADULTS	24.5 in 62 cm	28 in 71 cm	7.8 in 20 cm
XL (X-LARGE) IDEAL FOR LONG HAIR AND DREADLOCKS	27 in 68.5 cm	38 in 96.5 cm	11.4 in 29 cm

USA 12/2023

CRESSI'S SIZE CHART TO BE USED AS A REFERENCE ONLY



Art Direction:
Jenifer Chavez
Editorial & Cover Design:
Alejandra Gómez
Lifestyle images
by **Cressi Ambassadors**

© Cressi Sub S.P.A. All rights reserved.
Reproduction, scanning, transmittal or storage,
by any means of the images in this catalog, whole
or in part, is prohibited without the prior written
permission of Cressi Sub S.P.A.

2025 - CATALOG

CRESSI

BLUE

www.cressiusa.com



info@cressiusa.com



**THE PASSPORT
TO UNDERWATER
WORLD**